

MIL-DTL-38999 Series III circular connectors
Souriau 8D series

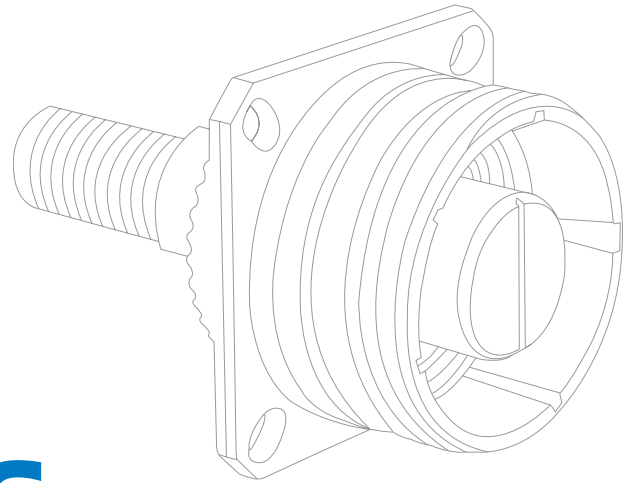

EATON

Powering Business Worldwide



8D series

MIL-DTL-38999 Series III

Typical applications



Table of contents

Overview 4

- Product overview 4
- Technical specifications 7
- Contact layouts 9

Standard series 18

- Aluminum series 18
- Composite series 31
- Stainless steel series 37
- Titanium series 43
- Bronze series 48

Common elements 54

- Contacts 54
- Wiring instructions 60
- Tooling 61
- Accessories 63
- Orientations 64
- Panel cut-out 64
- Coordinates for straight PC tail terminations 65

Derived series 73

- High speed solutions: 73
 - Twinax and Quadrax contacts 73
 - BMA coaxial contacts 79
 - ELIO® fiber optic contacts 83
 - ELIOBEAM fiber optic contacts 89
- Power solutions: 93
 - Power contacts 93
 - High power contacts 98
- Compact solutions: 103
 - High density 103
 - Plug with integrated backshell 105
- Smart design solutions: 109
 - High vibration plug: 8DV series 109
 - Receptacle with clinch nuts or helicoils 113
- PC tail contacts solutions: 116
 - Double flange receptacle 116
 - PCB contacts without shoulder 119
- Reinforced sealing: 121
 - Resin sealed 121
 - Hermetic 124

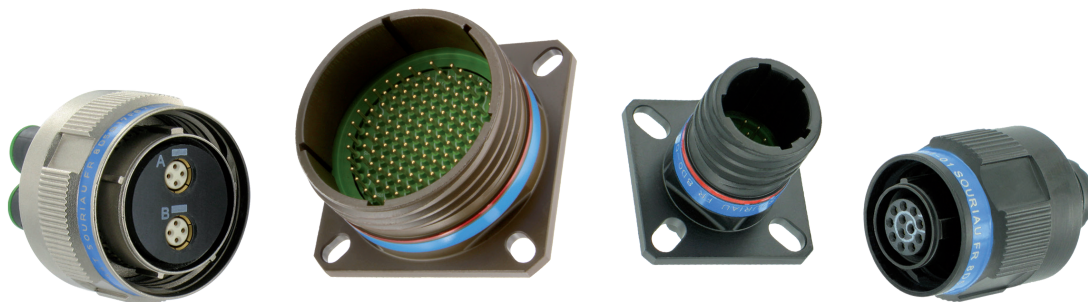

Souriau 8D series

Product overview

A superior concept

Five materials and platings



Aluminum

- Black zinc nickel RoHS
- Nickel RoHS
- Green zinc cobalt
- Olive drab cadmium
- Gray tin-zinc (with black coupling nut for plug) RoHS



Composite

- Nickel RoHS
- Olive drab cadmium
- Without plating

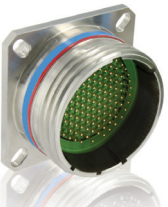

Stainless steel

- Passivated RoHS
- Nickel RoHS



Titanium

- Nickel RoHS
- Without plating

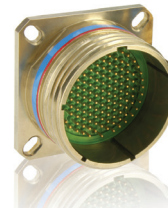

Bronze

- Without plating

Versatile & robust

Metallic retention clips

- Unique technology
- High performance contact retention
- Withstands high temperatures and high vibration

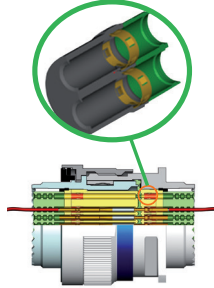

Accessories

- Full backshell offering
- Protective caps
- Tooling

High sealing

- IP67 rated
- Each contact cavity is individually sealed

Full contact offering

Versatility

- PC tail contacts with or without shoulder
- Crimp contacts
- Solder cup contacts
- Wire wrap contacts

High density

- #26 contact layouts

Adaptability

- Common cavity for all #8 contacts

Multi-contact technology

- Signal transmission
- High power up to 850A
- High speed data transmission
 - Quadrax
 - Coax
 - Twinax
 - Triax concentric twinax
 - ELIO® fiber optic
 - Expanded beam

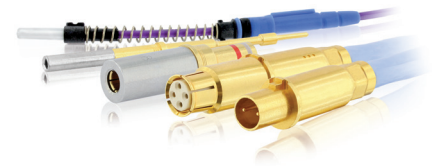

Derived series

Our range extends beyond our standard series with derived series and shell variants.

High speed solutions



Twinax and Quadrax contacts
see **Page 73**

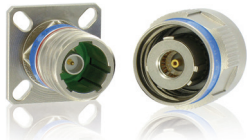

BMA coaxial contacts
see **Page 79**



ELIO® fiber optic contacts
see **Page 83**



ELIObeam fiber optic contacts
see **Page 89**

Power solutions



Power contacts
see **Page 93**



High power contacts
see **Page 98**

Compact solutions



High density
see **Page 103**



Plug with integrated backshell
see **Page 105**

Smart design solutions



High vibration: 8DV Series
see **Page 109**



Clinch nuts or helicoils
see **Page 113**

PC tail contacts solutions



Double flange receptacle
see **Page 116**



PC tail contact without shoulder
see **Page 119**

Reinforced sealing



Resin sealed connector
see **Page 121**



Glass sealed connector
see **Page 124**

Interconnect solutions

We provide a large variety of interconnect solutions to vector and secure the cable routing.



Backshells



Flexible conduits



Protective caps



Accessories

Souriau 8D Series

Product overview

MIL standard connector design

Quick coupling

1 1/4 turn to mate

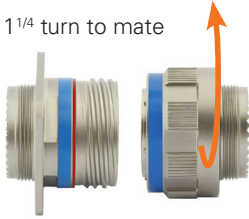

Scoop-proof

Eliminates risk of damaging contacts during the coupling operation



Fully shielded

Shell to shell bottoming = perfect shield continuity

360° shielding



Self locking mechanism

Connector will not unscrew under high vibration (44 g)

Visual mating

Red band visible = not correctly mated

Red band hidden = correctly mated

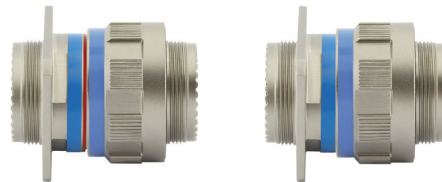

Universal product platform

MIL-DTL-38999 8LT Series I - Souriau 8LT series

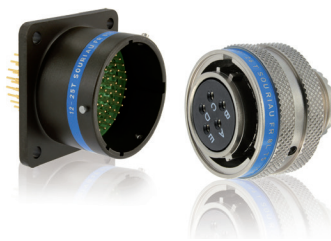

- High density MIL-spec circular
- Scoop-proof
- Bayonet coupling
- Mounting: screws or jam nut
- Shell: aluminum alloy
- Plating: cadmium, nickel, black zinc nickel or green zinc cobalt
- QPL approved
- Numerous layouts

MIL-DTL-38999 Series II - Souriau 8T series



- Short version of 38999 Series I
- High density MIL-spec circular
- Bayonet coupling
- Mounting: screws or jam nut
- Shell: aluminum alloy
- Plating: cadmium, nickel, black zinc nickel or hard anodized
- QPL approved

VG96912 & JN1003 - Souriau 8ST series



- High density
- Lightweight version of 38999 Series I
- Scoop-proof
- Bayonet coupling
- Mounting - screws or jam nut
- Shell: aluminum alloy
- Plating: cadmium, nickel or tin zinc
- VG 96912 German specification
- JN 1003 Typhoon specification



Description

The 8D series is a highly reliable circular connector compliant to several aerospace standards, including MIL-DTL-38999 series III, EN3645, BACC63, VG95319 and CECC.

- Screw quick coupling with a self-locking mechanism, visual mating indication, scoop-proof and 360° shielding
- Available in aluminum, composite, titanium, stainless steel and bronze
- Shell sizes from 9 to 25 with high contact density layouts available
- 54 QPL layouts in accordance with MIL-STD-1560
- Hermetic, high power up to 850A and optical layouts
- Full range of contacts include signal transmission, high speed data transmission; Quadrax, twinax, coax and ELIO optical termini
- Available accessories include protective caps and backshells

Mechanical

Shell

Aluminum, composite, stainless steel, bronze

Shell plating

- Aluminum shell:
 - Cadmium olive drab (W)
 - Nickel (F)
 - Black zinc nickel (Z)
 - Green zinc cobalt (ZC)
 - Gray tin-zinc (with black coupling nut for plug) (SZ)
- Composite shell:
 - Cadmium olive drab (J)
 - Nickel (M)
 - Without plating (X)
- Stainless steel shell:
 - Passivated (K)
 - Nickel (S)
- Titanium shell:
 - Without plating (TT)
 - Nickel (TF)
- Bronze shell:
 - Without plating

Insulator

Thermoplastic

Grommet and interfacial seal

Silicone elastomer

Contacts

Copper alloy

Contacts plating

Gold over nickel plated

Endurance

- 500 mating cycles all materials
- 1500 mating cycles for composite connectors with specific contacts

Shock

300 g, 3 ms

Vibration

- Sinus (D38999, EN3645, BACC63):
 - 10 a 2000 Hz, 3x12 hrs (60 g, 140 - 2000 Hz) with T° cycling
- Random:
 - 50 to 2000 Hz, 2x8 hrs (1 g2/ Hz, 100 - 2000 Hz) at T° max.
 - 25 to 2000 Hz, 2x8 hrs (5 g2/ Hz, 100 - 300 Hz) at ambient T°

Contact retention

Contacts size	26	22	20	16	12	8	4
Min force in N	30	44	67	111	111	111	200

Firewall connectors

- Passivated stainless steel (K)
- Nickel stainless steel (S)

Weight comparison

Example for a plug shell size 15

Materials	Weight	
Stainless steel	58.80 g	
Titanium	33.90 g	42% lighter
Aluminum	20.35 g	40% lighter
Composite	14.30 g	30% lighter

Electrical

Test voltage rating (Vrms)

Service	Sea level	at 21000 m
R	400	N/A
M	1 300	800
N	1 000	600
I	1 800	1 000
II	2 300	1 000

Contact resistance

Contacts size	26	22	20	16	12	8	4
Resistance mΩ	16	14.6	7.3	3.8	3.5	3	2

Souriau 8D series

Technical specifications

Insulation resistance

≥ 5 000 MΩ (under 500 Vdc)

Contact rating

Contacts size	26	22	20	16	12	10	8	4
Rating (A)	3	5	7.5	13	23	33	45	80

Shell continuity

- Aluminum shell:
 - Cadmium olive drab (W): 2.5 mΩ
 - Nickel (F): 1 mΩ
 - Black zinc nickel (Z): 2.5 mΩ
 - Green zinc cobalt (ZC): 2.5 mΩ
 - Gray tin-zinc (with black coupling nut for plug) (SZ): 2.5 mΩ
- Composite shell:
 - Cadmium olive drab (J): 3 mΩ
 - Nickel (M): 3 mΩ
- Stainless steel shell:
 - Passivated (K): 10 mΩ
 - Nickel (S): 1 mΩ
- Titanium shell:
 - Without plating (TT): 10 mΩ
 - Nickel (TF): 1 mΩ
- Bronze shell:
 - Without plating: 5 mΩ

Shielding

- Aluminum shell:
 - F: 65 db at 10 GHz
 - Z, F, W & SZ: 85 db at 1 GHz
 - Z, W & SZ: 50 db at 10 GHz
 - ZC: Consult us
- Composite shell:
 - J & M: 85 db at 1 GHz
- Stainless steel shell:
 - K: 45 db at 10 GHz
 - S: 65 db at 10 GHz
- Titanium shell:
 - TT: 45 db at 10 GHz
 - TF: 65 db at 10 GHz
- Bronze shell:
 - 85 db at 10 GHz

Environmental

Temperature range

- Aluminum shell:
 - W: -65°C +175°C
 - F: -65°C +200°C
 - Z: -65°C +175°C
 - ZC: -65°C +175°C
 - SZ: -65°C +175°C
- Composite shell:
 - J: -65°C +175°C
 - M: -65°C +175°C
 - Without plating (X): -65°C +175°C
- Stainless steel shell:
 - K: -65°C +200°C
 - S: -65°C +200°C
- Titanium shell:
 - TT: -65°C +200°C
 - TF: -65°C +200°C
- Bronze shell:
 - Without plating: -65°C +175°C

Sealing

Mated connectors meet altitude immersion requirements of MIL-DTL-38999

Salt spray

- Aluminum shell:
 - W: 500 hrs
 - F: 48 hrs
 - Z: 500 hrs
 - ZC: 250 hrs
 - SZ: 500 hrs
- Composite shell:
 - J: 2000 hrs
 - M: 2000 hrs
 - Without plating (X): 2000 hrs
- Stainless steel shell:
 - K: 500 hrs
 - S: 500 hrs
- Titanium shell:
 - TT: 500 hrs
 - TF: 48 hrs
- Bronze shell:
 - Without plating: 500 hrs

Resistance to fluids

According to MIL-DTL-38999 standard

- Gasoline: JP5 (OTAN F44)
- Mineral hydraulic fluid: MIL-H-5606 (OTAN H515)
- Synthetic hydraulic fluid: Skydrol 500 B4

LD4 (SAE AS 1241)

- Mineral lubricating: MIL-L-7870A (OTAN 0142)
- Synthetic lubricating: MIL-L-23699 (OTAN 0156), MIL-L-7808
- Cleaning fluid: MIL-C-87936 diluted
- De-icing fluid: MIL-A-8243
- Extinguishing fluid: Bromochloromethane
- Cooling fluid: Coolanol

Contact layouts

- P Power or high power
 Q Quadrax or twinax
 C Concentric twinax (=triaux) or coax
 HD High density
 H Hermetic version developed
 F Fiber optic ELIO® or expanded beam
- Contact sizes
 ● #26 ○ #22D ◐ #20 ◑ #16 ◒ #12 ◓ #10 ◔ #8 Quadrax or twinax ◕ Fiber optic ELIO® or expanded beam
 ◖ #8 Triax (=Concentric twinax) or coax - consult us ◗ #8 Power ◘ #4 Power ◙ High power

09 / A

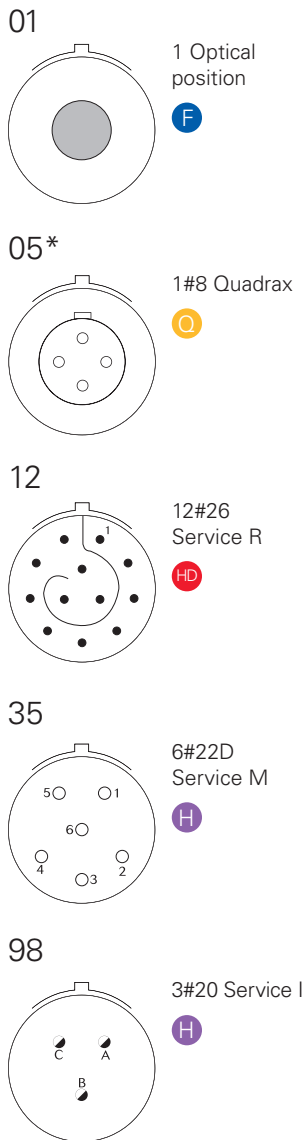

*** 09-05 layout:**

- Grounded version only (spec. 620)
- Plug with female contact & receptacle with male contact only

11 / B

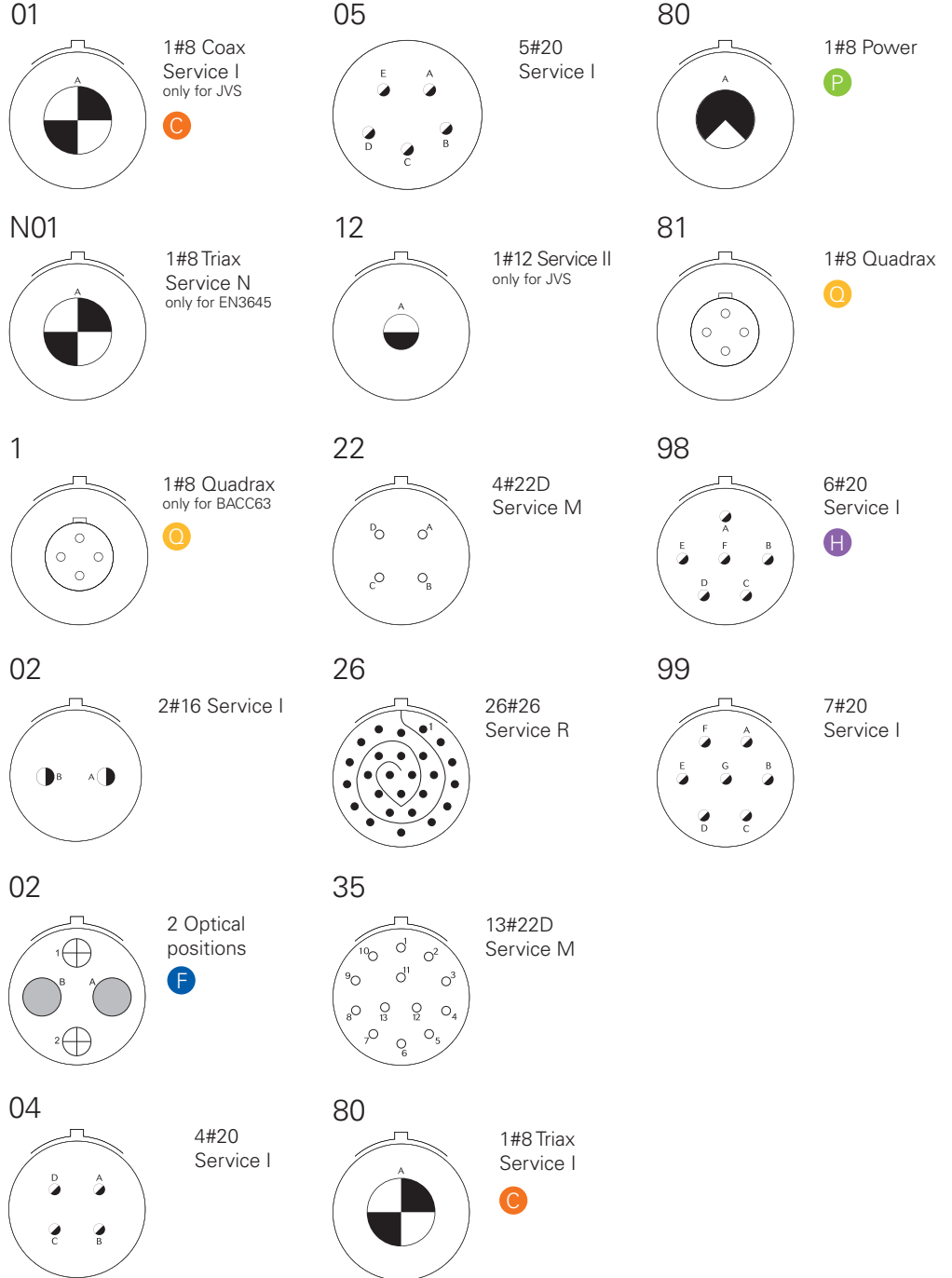

As stated in MIL-DTL-38999 standard, insert arrangements using multi-axial contacts (i.e. coax, twinax, Quadrax) should not be used in firewall applications.

Souriau 8D series

Contact layouts

Contact layouts

P Power or high power
 Q Quadrax or twinax
 C Concentric twinax (=triax) or coax
 HD High density
 H Hermetic version developed
 F Fiber optic ELIO® or expanded beam

13 / C

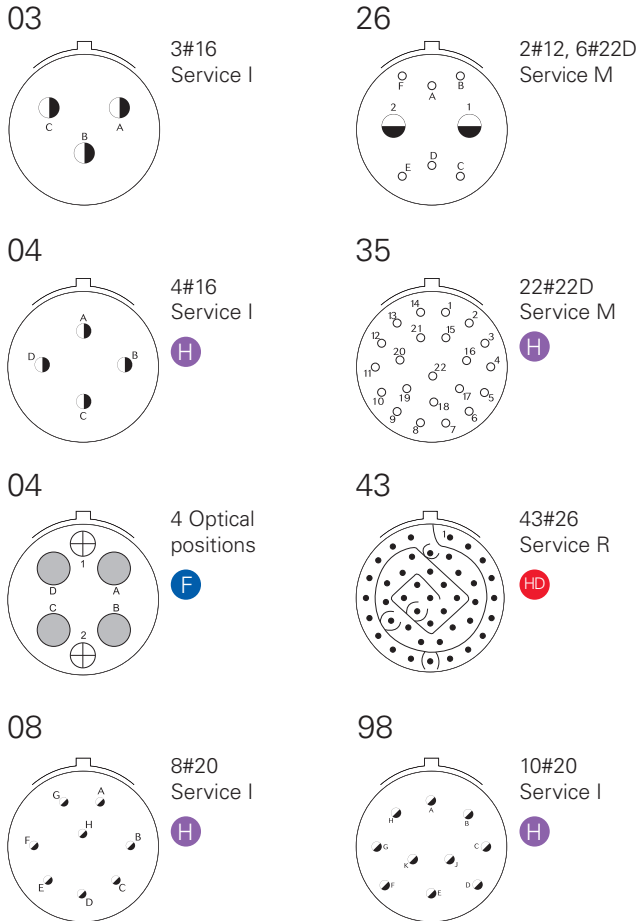

15 / D

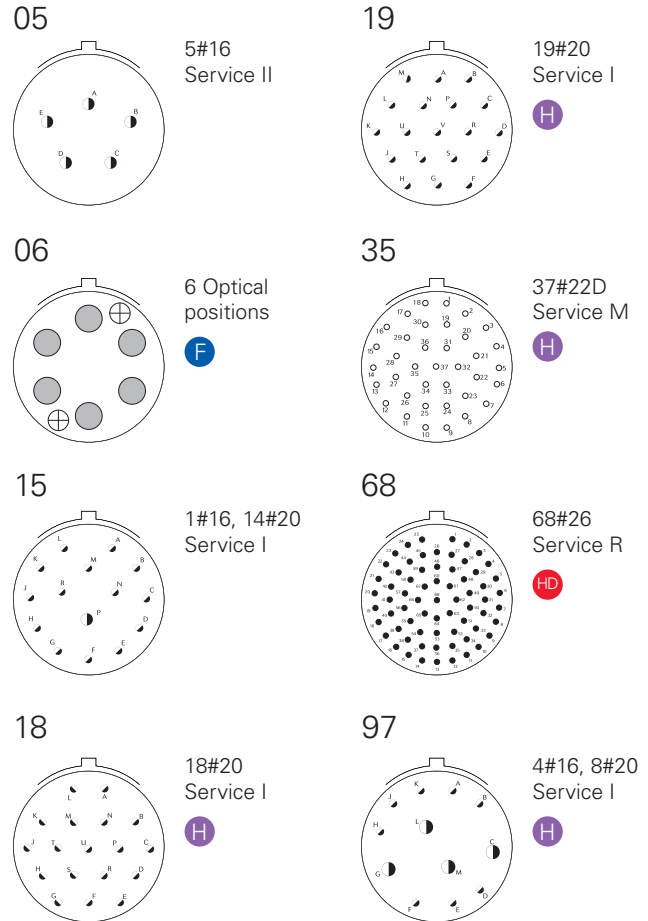

As stated in MIL-DTL-38999 standard, insert arrangements using multi-axial contacts (i.e. coax, twinax, Quadrax) should not be used in firewall applications.

Contact layouts

- P Power or high power
- Q Quadrax or twinax
- C Concentric twinax (=triax) or coax
- HD High density
- H Hermetic version developed
- F Fiber optic ELIO® or expanded beam

17 / E

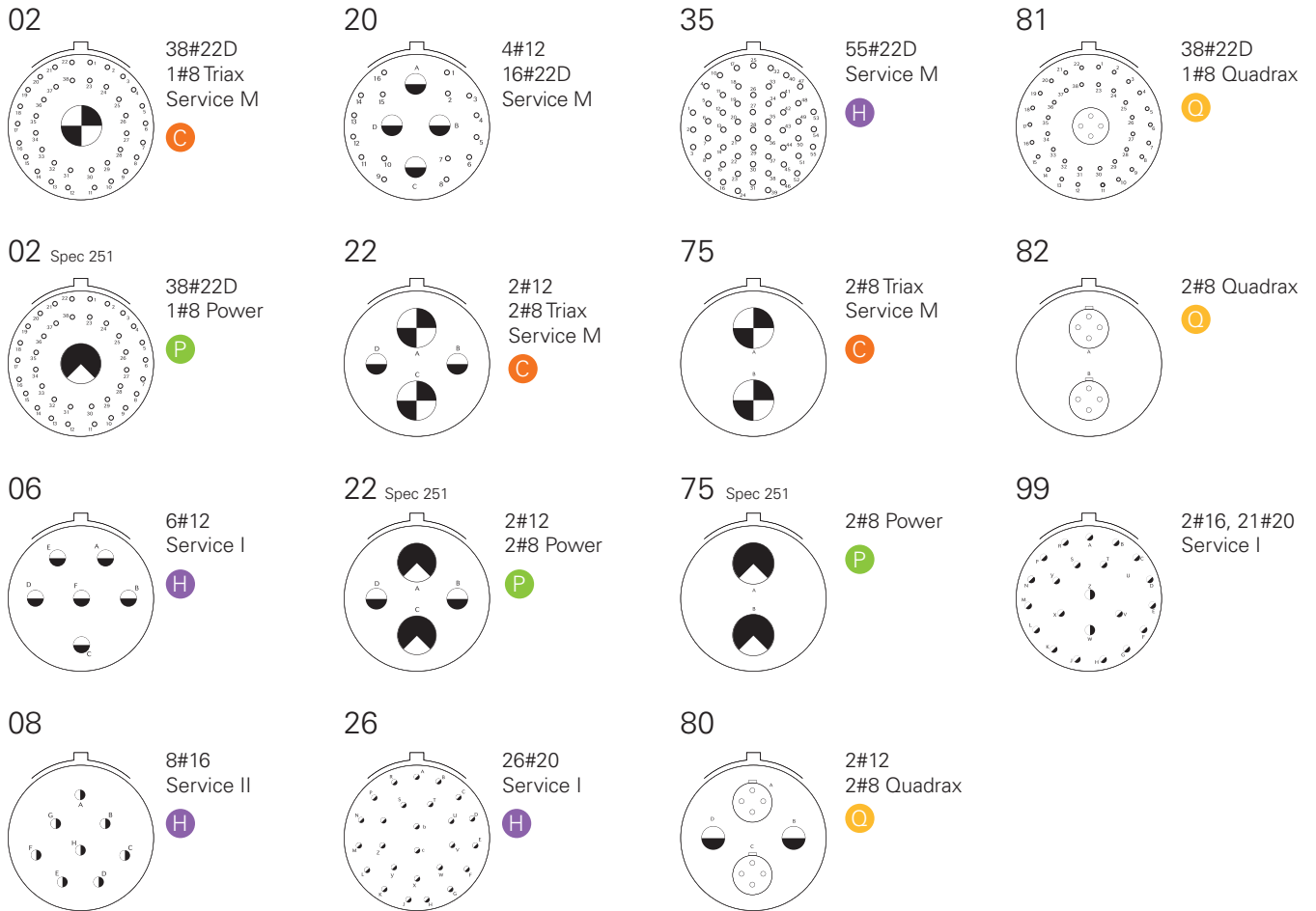

As stated in MIL-DTL-38999 standard, insert arrangements using multi-axial contacts (i.e. coax, twinax, Quadrax) should not be used in firewall applications.

Souriau 8D series

Contact layouts



Contact layouts

- P Power or High Power
- Q Quadrax or Twinax
- C Concentric Twinax (=Triax) or Coax
- HD High Density
- H Hermetic version developed
- F Fiber optic ELIO® or Expanded beam

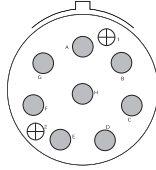
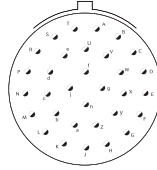
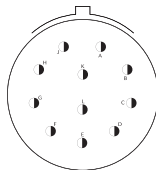
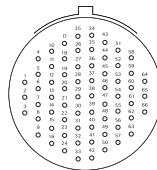
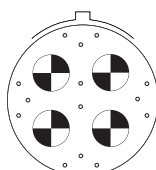
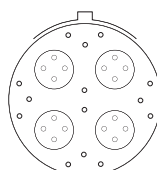
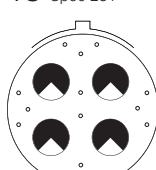
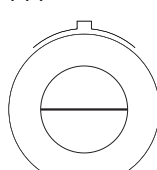
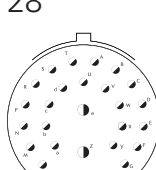
19 / F

<p>08</p>  <p>8 Optical positions F</p>	<p>32</p>  <p>32#20 Service I</p>
<p>11</p>  <p>11#16 Service II</p>	<p>35</p>  <p>66#22D Service M H</p>
<p>18</p>  <p>14#22D 4#8 Triax Service M C</p>	<p>84</p>  <p>14#22D 4#8 Quadrax Q</p>
<p>18 Spec 251</p>  <p>14#22D 4#8 Power P</p>	<p>H1</p>  <p>1#00 High power P</p>
<p>28</p>  <p>26#20 2#16 Service I</p>	

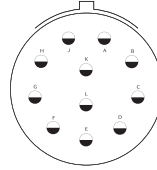
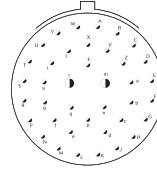
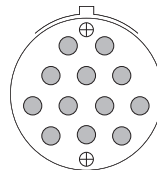
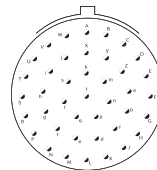
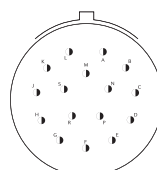
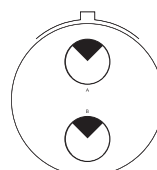
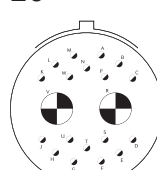
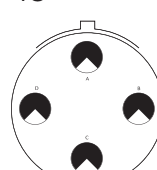
21 / G

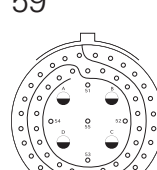
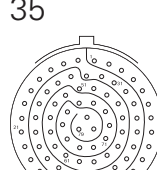
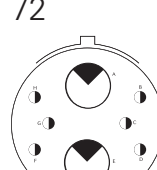
<p>11</p>  <p>11#12 Service I</p>	<p>39</p>  <p>2#16 37#20 Service I</p>
<p>12</p>  <p>12 Optical positions F</p>	<p>41</p>  <p>41#20 Service I H</p>
<p>16</p>  <p>16#16 Service II</p>	<p>42</p>  <p>2#4 Power Service I P</p>
<p>20</p>  <p>18#20 2#8 Triax Service M C</p>	<p>48</p>  <p>4#8 Power Service I P H</p>
<p>20 Spec 251</p>  <p>18#20 2#8 Power P</p>	<p>59</p>  <p>55#22D 4#12 Service M</p>
<p>35</p>  <p>79#22D Service M</p>	<p>72</p>  <p>6#16 2#4 Power Service I P</p>

As stated in MIL-DTL-38999 standard, insert arrangements using multi-axial contacts (i.e. coax, twinax, Quadrax) should not be used in firewall applications.

Contact layouts

P Power or High Power
 Q Quadrax or Twinax
 C Concentric Twinax (=Triax) or Coax
 HD High Density
 H Hermetic version developed
 F Fiber optic ELIO® or Expanded beam

21 / G

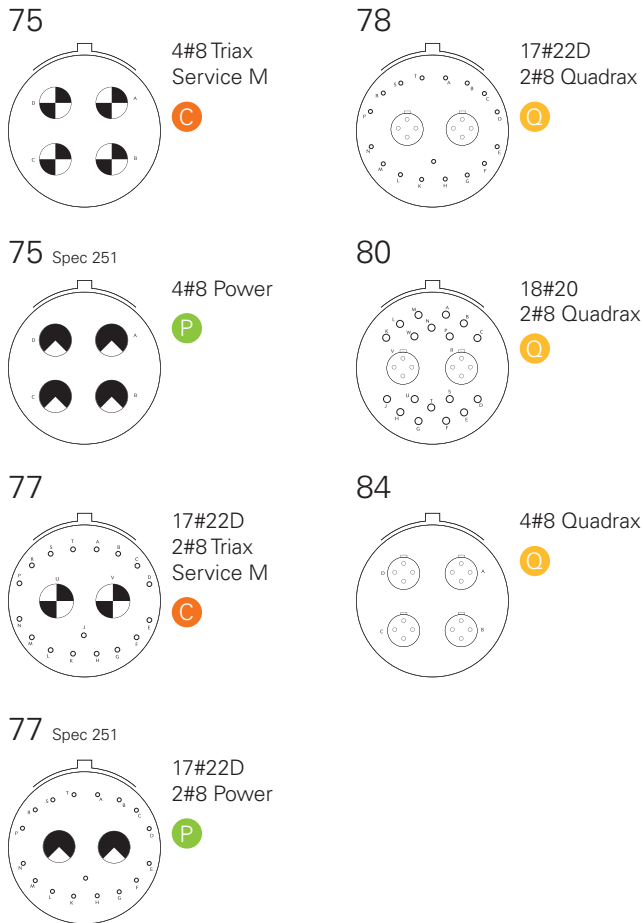

23 / H

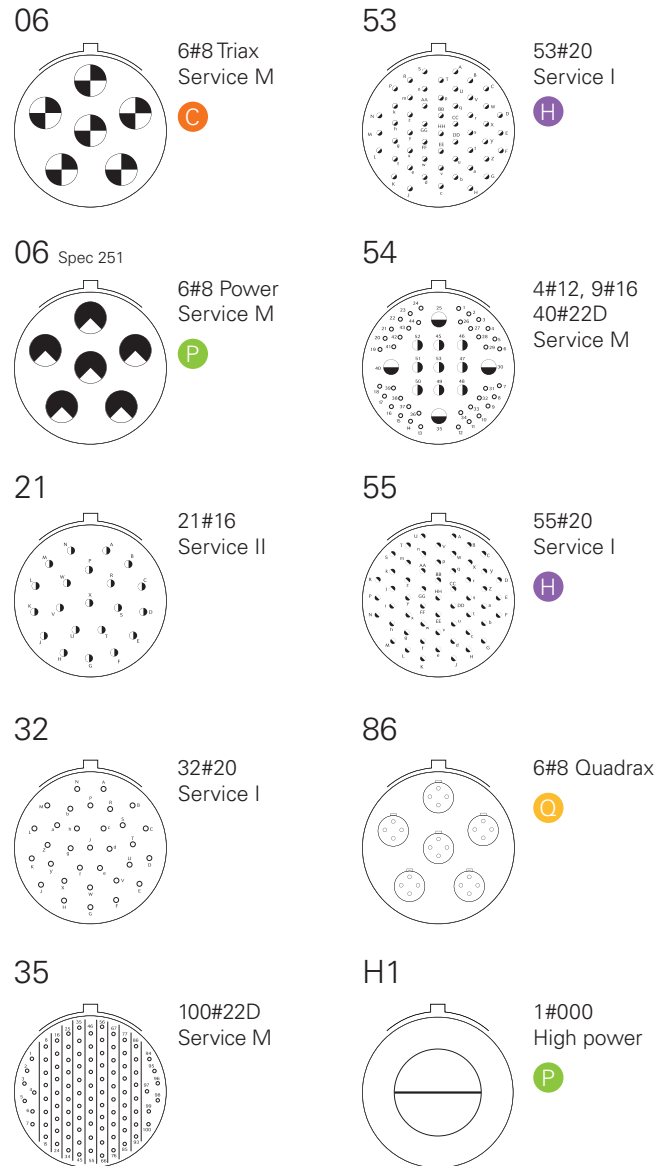

As stated in MIL-DTL-38999 standard, insert arrangements using multi-axial contacts (i.e. coax, twinax, Quadrax) should not be used in firewall applications.

Souriau 8D series

Contact layouts

Contact layouts

P Power or High Power
 Q Quadrax or Twinax
 C Concentric Twinax (=Triax) or Coax
 HD High Density
 H Hermetic version developed
 F Fiber optic ELIO® or Expanded beam

25 / J

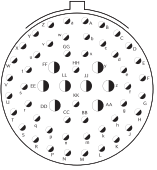
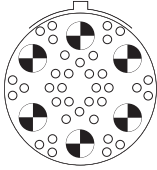
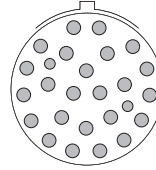
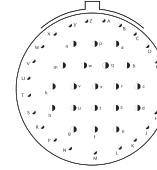
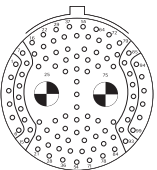
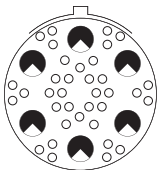
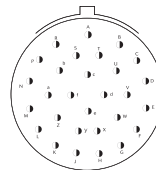
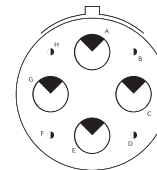
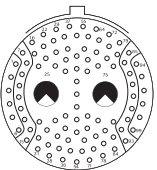
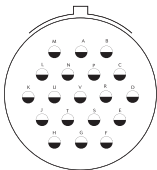
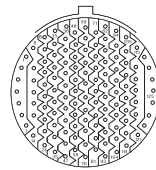
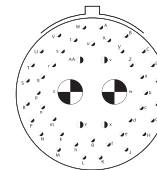
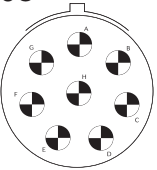
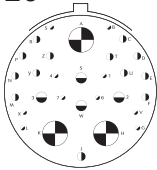
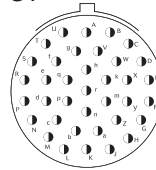
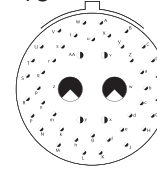
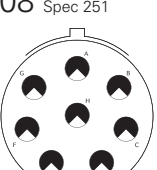
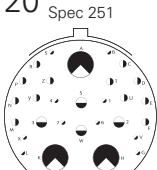
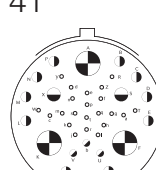
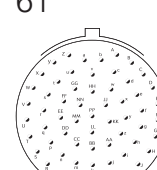
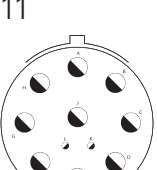
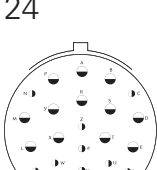
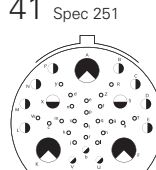
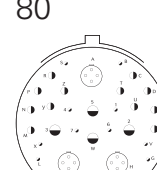
<p>04</p>  <p>48#20 8#16 Service I H</p>	<p>17</p>  <p>36#22D 6#8 Triax C</p>	<p>24</p>  <p>24 Optical positions F</p>	<p>43</p>  <p>23#20 20#16 Service I</p>
<p>07</p>  <p>97#22D 2#8 Triax Service M C</p>	<p>17 Spec 251</p>  <p>36#22D 6#8 Power P</p>	<p>29</p>  <p>29#16 Service I</p>	<p>44</p>  <p>4#16 4#4 Power Service I P</p>
<p>07 Spec 251</p>  <p>97#22D 2#8 Power P</p>	<p>19</p>  <p>19#12 Service I H</p>	<p>35</p>  <p>128#22D Service M</p>	<p>46</p>  <p>40#20, 4#16 2#8 Coax Service I C</p>
<p>08</p>  <p>8#8 Triax Service M C</p>	<p>20*</p>  <p>10#20 13#16 4#12 Coax 3#8 Triax Service N C</p>	<p>37</p>  <p>37#16 Service II</p>	<p>46 Spec 251</p>  <p>40#20, 4#16 2#8 Power Service I P</p>
<p>08 Spec 251</p>  <p>8#8 Power P</p>	<p>20* Spec 251</p>  <p>10#20 13#16 4#12 3#8 Power P</p>	<p>41</p>  <p>22#22D, 3#20 11#16, 2#12 3#8 Triax Service M C</p>	<p>61</p>  <p>61#20 Service I</p>
<p>11</p>  <p>2#20 9#10 Service N</p>	<p>24</p>  <p>12#16 12#12 Service I</p>	<p>41 Spec 251</p>  <p>22#22D 3#20 11#16, 2#12 3#8 Power P</p>	<p>80</p>  <p>10#20 13#16 4#12 Coax 3#8 Quadrax Q</p>

* For shell type 1 and/or bronze material: please consult us.

As stated in MIL-DTL-38999 standard, insert arrangements using multi-axial contacts (i.e. coax, twinax, Quadrax) should not be used in firewall applications.

Contact layouts

- P Power or High Power
- Q Quadrax or Twinax
- C Concentric Twinax (=Triax) or Coax
- HD High Density
- H Hermetic version developed
- F Fiber optic ELIO® or Expanded beam

25 / J

81



88

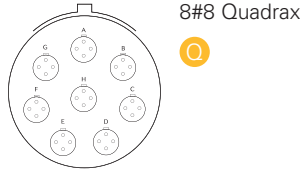

82

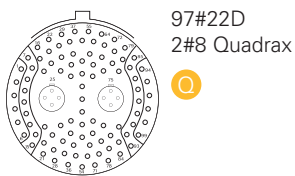

90



86

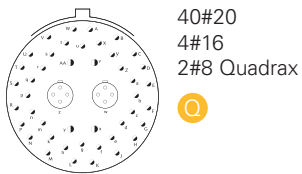

H1

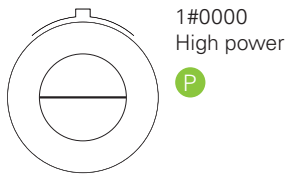

87

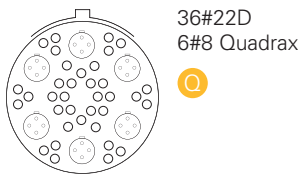

As stated in MIL-DTL-38999 standard, insert arrangements using multi-axial contacts (i.e. coax, twinax, Quadrax) should not be used in firewall applications.

Souriau 8D series

Contact layouts

Contact layouts (matrix)

Shell size	Layout	MIL-DTL-38999 (QPL)		JVS-CECC bronze connector	Hermetics	EN3645	BACC63 CT/CU DB/DC	VG95319	Number of contacts	#26	#22D	#20	#16	#12	#10	#8	#4	Fiber optic or high power
		aluminum, stainless steel & composite	8D titanium															
09 / A	09-01	S	S	S					1									1 Optic
	09-05 (1)	S	S	S			Q (2)		1							1 Qdx		
	09-12	S							12	12								
	09-35	Q	S	Q	S	Q	Q	Q	6		6							
	09-98	Q	S	Q	S	Q	Q	Q	3			3						
11 / B	11-01	S	S						1					1				
	11-01			S			Q		1								1 Coax	
	11N01						Q										1 Twx	
	11-1						Q										1 Qdx	
	11-02	Q	S	Q		Q	Q	Q	2				2					
	11-02	S	S	S					2									2 Optic
	11-04	Q	S	S			Q	Q	4			4						
	11-05	Q	S	Q		Q	Q	Q	5			5						
	11-12			S		Q			1					1				
	11-22	S	S	S					4		4							
	11-26	S							26	26								
	11-35	Q	S	Q	S	Q	Q	Q	13		13							
	11-80	S	S	S					1								1 Twx	
	11-80 sp.251	S	S	S					1								1 Pow	
	11-81	S	S	S					1								1 Qdx	
11-98	Q	S	Q	S	Q	Q	Q	6			6							
11-99	Q	S	Q		Q	Q	Q	7			7							
13 / C	13-03	S	S	S					3				3					
	13-04	Q	S	Q	S	Q	Q	Q	4				4					
	13-04	S	S	S					4								4 Optic	
	13-08	Q	S	Q	S	Q	Q	Q	8			8						
	13-26	S	S	Q		Q			8		6			2				
	13-35	Q	S	Q	S	Q	Q	Q	22		22							
	13-43	S							43	43								
	13-98	Q	S	Q	S	Q	Q	Q	10			10						
15 / D	15-05	Q	S	Q		Q	Q	Q	5				5					
	15-06	S	S	S					6								6 Optic	
	15-15	Q	S	Q		Q	Q	Q	15			14	1					
	15-18	Q	S	Q	S	Q	Q	Q	18			18						
	15-19	Q	S	Q	S	Q	Q	Q	19			19						
	15-35	Q	S	Q	S	Q	Q	Q	37		37							
15-97	Q	S	Q	S	Q	Q	Q	12			8	4						
17 / E	17-02	Q	S	S		Q	Q	Q	39		38						1 Twx	
	17-02 sp.251	S	S	S					39		38						1 Pow	
	17-06	Q	S	Q	S	Q	Q	Q	6				6					
	17-08	Q	S	Q	S	Q	Q	Q	8				8					
	17-20	S	S	S		Q			20		16			4				
	17-22	S	S	S		Q			4					2		2 Twx		
	17-22 sp.251	S	S	S					4					2		2 Pow		
	17-26	Q	S	Q	S	Q	Q	Q	26			26						
	17-35	Q	S	Q	S	Q	Q	Q	55		55							
	17-75	S	S	S		Q			2								2 Twx	
	17-75 sp.251	S	S	S					2								2 Pow	
	17-80	S	S	S					4					2		2 Qdx		
	17-81	S	S	S					39		38						1 Qdx	
17-82	S	S	S			Q		2								2 Qdx		
17-99	Q	S	Q		Q	Q	Q	23			21	2						
19 / F	19-08	S	S	S					8								8 Optic	
	19-11	Q	S	Q		Q	Q	Q	11				11					
	19-18	Q	S	S			Q	Q	18		14					4 Twx		
	19-18 sp.251	S	S	S														
	19-28	Q	S	Q			Q		28			26	2					
	19-32	Q	S	Q		Q	Q	Q	32			32						
	19-35	Q	S	Q	S	Q	Q	Q	66		66							
	19-84	S	S	S					18		14						4 Qdx	
	19-H1	S							1								1 #00	

S Souriau layout

Q Layout qualified according to corresponding norm

(1) Grounded insert only - Please consult us

(2) Only for BACC63CT/CU

#8 Pow: Power; Qdx: Quadrax; Twx: Concentric twinax

As stated in MIL-DTL-38999 standard, insert arrangements using multi-axial contacts (i.e. coax, twinax, Quadrax) should not be used in firewall applications.

Contact layouts (matrix)

Shell size	Layout	MIL-DTL-38999 (QPL)		JVS-CECC connector	Hermetics EN3645	BACC63 CT/CU DB/DC	VG95319	Number of contacts	#26	#22D	#20	#16	#12	#10	#8	#4	Fiber optic or high power	
		aluminum, stainless steel & composite	8D titanium															
21 / G	21-11	Q	S	Q	Q	Q	Q	11					11					
	21-12	S	S	S				12									12 Optic	
	21-16	Q	S	Q	Q	Q	Q	16				16						
	21-20	S	S	S				20			18						2 Twx	
	21-20 sp.251	S	S	S				20			18						2 Pow	
	21-35	Q	S	Q	Q	Q	Q	79		79								
	21-39	Q	S	Q	Q	Q	Q	39			37	2						
	21-41	Q	S	Q	S	Q	Q	41			41							
	21-42	S	S	S				2										2 Pow
	21-48	S	S	Q	S			4										4 Pow
	21-59	S	S	S				59		55			4					
	21-72	S	S	S				8				6						2 Pow
	21-75	Q	S	S		Q	Q	Q	4									4 Twx
	21-75 sp.251	S	S	S				4										4 Pow
	21-77	S	S					19			17							2 Twx
	21-77 sp.251	S	S	S				19			17							2 Pow
	21-78	S	S				Q	19			17							2 Qdx
	21-80	S	S	S				20				18						2 Qdx
	21-84	S	S	S			Q (2)	4										4 Qdx
	23 / H	23-06	S	S	S	Q			6									6 Twx
23-06 sp.251		S	S	S				6									6 Pow	
23-21		Q	S	Q	Q	Q	Q	21				21						
23-32		Q	S	S				32				32						
23-35		Q	S	Q	Q	Q	Q	100		100								
23-53		Q	S	Q	S	Q	Q	Q	53				53					
23-54		S	S	S		Q		53		40		9	4					
23-55		Q	S	Q	S	Q	Q	Q	55			55						
23-86		S	S	S				6										6 Qdx
23-H1		S						1										1 #000
25 / J		25-04	Q	S	S	S	Q	Q	Q	56			48	8				
	25-07	Q	S	S		Q	Q	Q	99		97						2 Twx	
	25-07 sp.251	S	S	S					99		97						2 Pow	
	25-08	Q	S	Q (3)		Q	Q	Q	8								8 Twx	
	25-08 sp.251	S	S	S					8								8 Pow	
	25-11	Q	S	S		Q	Q	Q	11			2			9			
	25-17	S	S	S				42		36							6 Twx	
	25-17 sp.251	S	S	S				42		36							6 Pow	
	25-19	Q	S	Q	S	Q	Q	Q	19					19				
	25-20	Q	S	S		Q	Q	Q	30			10	13	4 (4)			3 Twx	
	25-20 sp.251	S	S	S				30			10	3	4				3 Pow	
	25-24	Q	S	Q		Q	Q	Q	24				12	12				
	25-24	S	S	S				24										24 Optic
	25-29	Q	S	Q		Q	Q	Q	29				29					
	25-35	Q	S	Q		Q	Q	Q	128		128							
	25-37	Q	S	S		Q	Q	Q	37				37					
	25-41	S	S	S				41			22	3	11	2				3 Twx
	25-41 sp.251	S	S	S				41			22	3	11	2				3 Pow
	25-43	Q	S	Q		Q	Q	Q	43			23	20					
	25-44	S	S	S				8				4						4 Pow
	25-46	Q	S	S		Q	Q	Q	46			40	4					2 Coax
	25-46 sp.251	S	S	S				46			40	4						2 Pow
	25-61	Q	S	Q		Q	Q	Q	61			61						
	25-80	S	S	S				30				10	13	4				3 Qdx
25-81	S	S	S				41			22	3	11	2				3 Qdx	
25-82	S	S	S				99			97							2 Qdx	
25-86	S	S	S				46				40	4					2 Qdx	
25-87	S	S	S				42			36							6 Qdx	
25-88	S	S	S				8										8 Qdx	
25-90	Q	S	S			Q	46				40	4					2 Twx	
25-H1	S						1										1 #0000	

S Souriau layout

Q Layout qualified according to corresponding norm

#8 Pow: Power; Qdx: Quadrax; Twx: Concentric twinax

(2) Only for BACC63CT/CU

(3) For CECC, layout 25-08 only delivered without contact

(4) 4 #12 coax (2+2)

As stated in MIL-DTL-38999 standard, insert arrangements using multi-axial contacts (i.e. coax, twinax, Quadrax) should not be used in firewall applications.

Souriau 8D series - aluminum

Part numbers

Connector part numbers

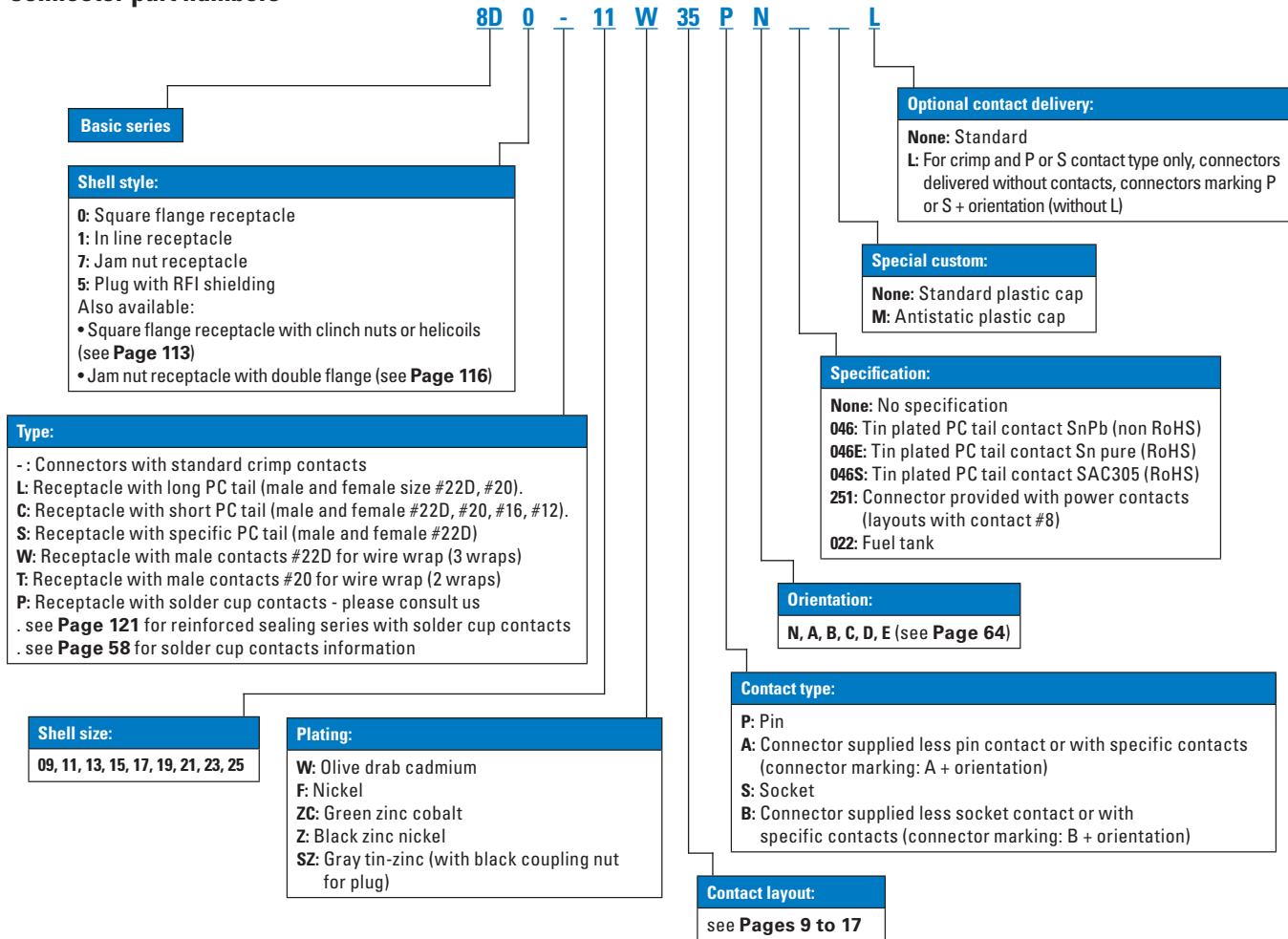

Note: PC tail contacts without shoulder also available. Please see **Page 120**.

MIL-DTL-38999 part numbers

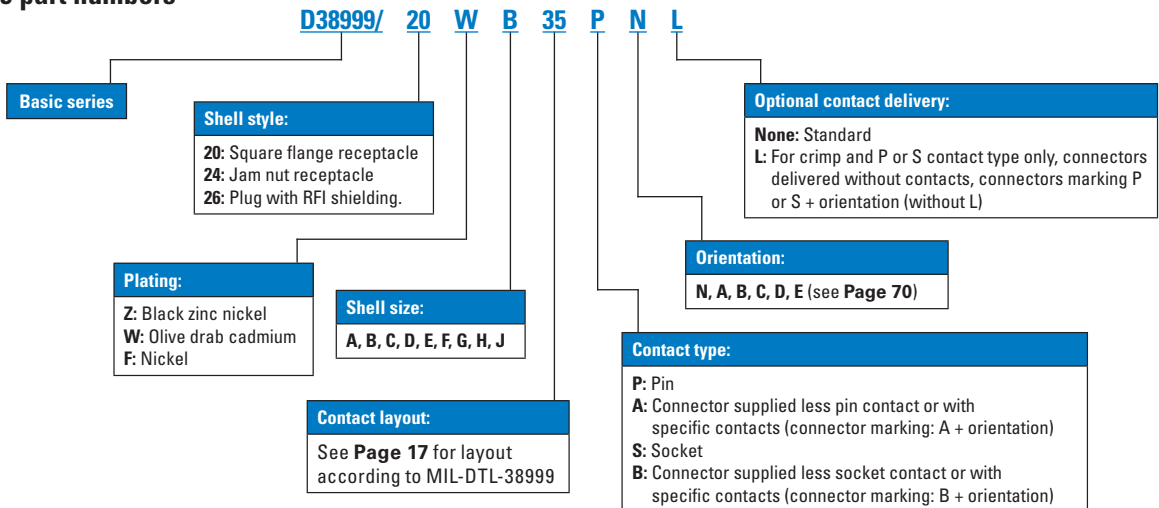

Note: To place an order of MIL connectors delivered without MIL removable crimp contacts and keep P or S plus orientation marking, it must be clearly specified on the order (by adding a suffix L at the end of the P/N or specified in comment).

Delivered with MIL contacts mandatory.

As stated in MIL-DTL-38999 standard, insert arrangements using multi-axial contacts (i.e. coax, twinax, Quadrax) should not be used in firewall applications.

EN3645 part numbers

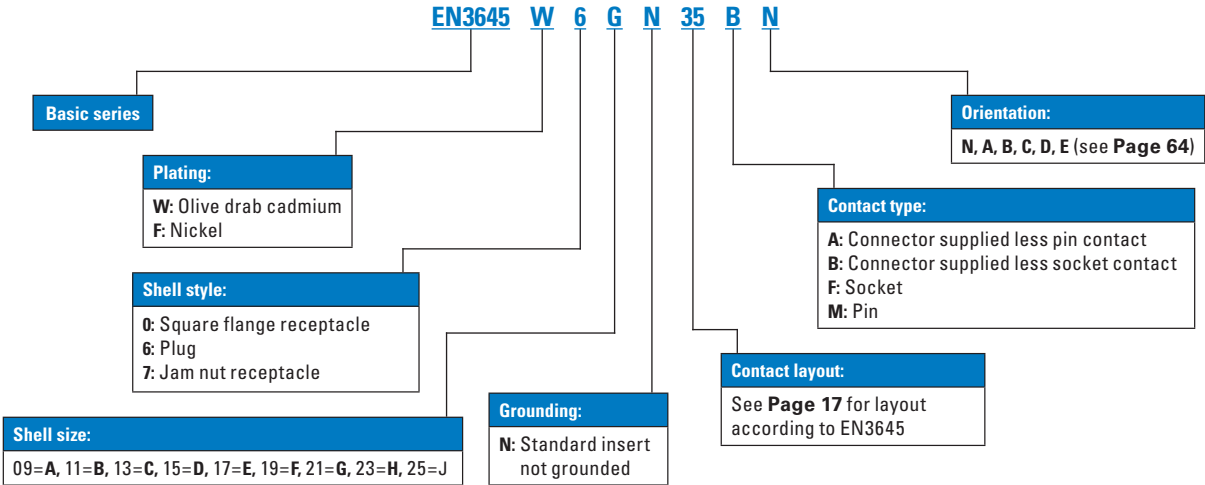

VG95319-1016 part numbers

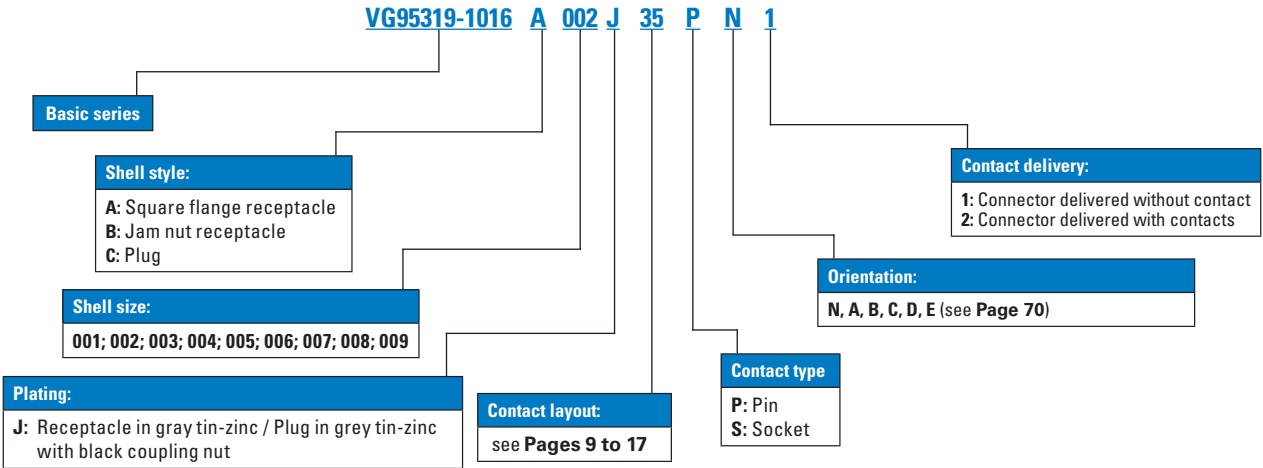

Souriau 8D series - aluminum

Dimensions

Dimensions

Plug type 5

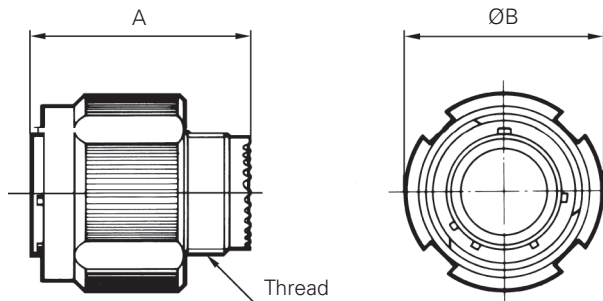

Shell size	A Max	Thread	ØB Max
09 (A)	31.00	M12 x 1-6g	21.80
11 (B)	31.00	M15 x 1-6g	25.00
13 (C)	31.00	M18 x 1-6g	29.40
15 (D)	31.00	M22 x 1-6g	32.50
17 (E)	31.00	M25 x 1-6g	35.70
19 (F)	31.00	M28 x 1-6g	38.50
21 (G)	31.00	M31 x 1-6g	41.70
23 (H)	31.00	M34 x 1-6g	44.90
25 (J)	31.00	M37 x 1-6g	48.00

Receptacle type 1

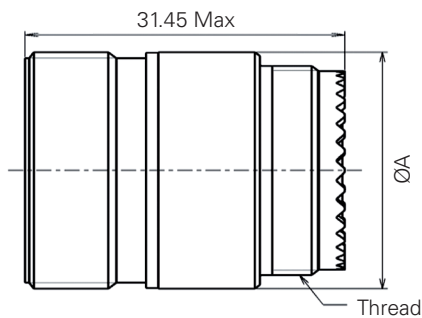

Shell size	Thread	ØA
09 (A)	M12 x 1-6g	15.90
11 (B)	M15 x 1-6g	19.00
13 (C)	M18 x 1-6g	22.25
15 (D)	M22 x 1-6g	25.45
17 (E)	M25 x 1-6g	30.20
19 (F)	M28 x 1-6g	31.75
21 (G)	M31 x 1-6g	34.95
23 (H)	M34 x 1-6g	38.10
25 (J)	M37 x 1-6g	41.30

Receptacle type 7

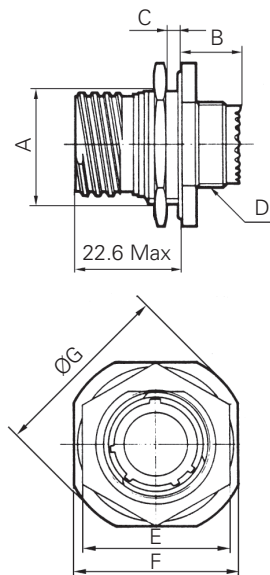

Shell size	A±0.15	B Max	C Max	D Thread	E Max	F ^{0.4}	ØG Max
09 (A)	16.53	9.9	3.2	M12 x 1-6g	23	27	30.5
11 (B)	19.07	9.9	3.2	M15 x 1-6g	26	31.8	35.2
13 (C)	23.82	9.9	3.2	M18 x 1-6g	31	34.9	38.4
15 (D)	26.97	9.9	3.2	M22 x 1-6g	34	38.1	41.6
17 (E)	30.15	9.9	3.2	M25 x 1-6g	37	41.3	44.8
19 (F)	33.32	9.9	3.2	M28 x 1-6g	40.5	46	49.5
21 (G)	36.50	9.9	3.2	M31 x 1-6g	43.5	49.2	52.7
23 (H)	39.67	9.9	3.2	M34 x 1-6g	47	52.4	55.9
25 (J)	42.85	9.9	3.2	M37 x 1-6g	51.23	55.6	59

Recommended coupling torque on panel for jam nut receptacle (type 7)

Shell	09 (A)	11 (B)	13 (C)	15 (D)	17 (E)	19 (F)	21 (G)	23 (H)	25 (J)
Coupling torque (±0.5 N.m)	4	5	7	8	9	10	12	13	14

Note: All dimensions are in millimeters (mm).

Receptacle type 0

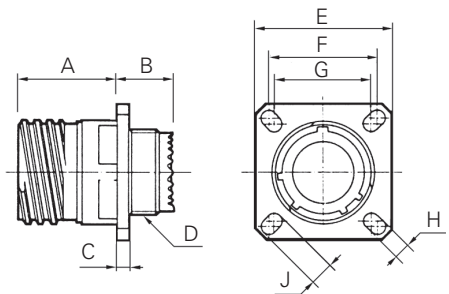

Shell size	A Max	B Max	C Max	D Thread	E ^{+0.3}	F	G	H ^{+0.2}	J ^{+0.2}
09 (A)	20.9	10.72	2.5	M12 x 1-6g	23.8	18.26	15.09	3.25	5.49
11 (B)	20.9	10.72	2.5	M15 x 1-6g	26.2	20.62	18.26	3.25	4.93
13 (C)	20.9	10.72	2.5	M18 x 1-6g	28.6	23.01	20.62	3.25	4.93
15 (D)	20.9	10.72	2.5	M22 x 1-6g	31	24.61	23.01	3.25	4.39
17 (E)	20.9	10.72	2.5	M25 x 1-6g	33.3	26.97	24.61	3.25	4.93
19 (F)	20.9	10.72	2.5	M28 x 1-6g	36.5	29.36	26.97	3.25	4.93
21 (G)	20.07	11.54	3.2	M31 x 1-6g	39.7	31.75	29.36	3.25	4.93
23 (H)	20.07	11.54	3.2	M34 x 1-6g	42.9	34.93	31.75	3.91	6.15
25 (J)	20.07	11.54	3.2	M37 x 1-6g	46	38.1	34.93	3.91	6.15

Mated connectors

Type 0 with plug

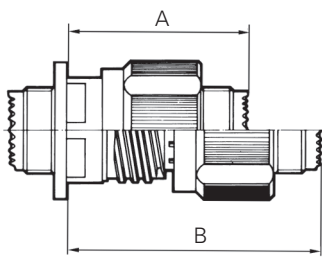

Type 7 with plug

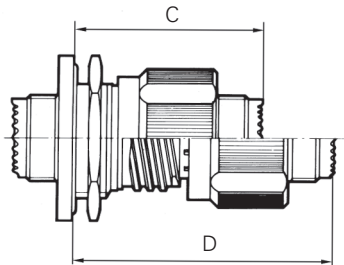

Shell size	A Max	B Max	C Max	D Max
09 to 11	37.00	52.30	38.30	53.60
13 to 19	37.00	52.30	38.50	53.80
21 to 25	36.00	51.30	38.50	53.80

Dummy receptacle

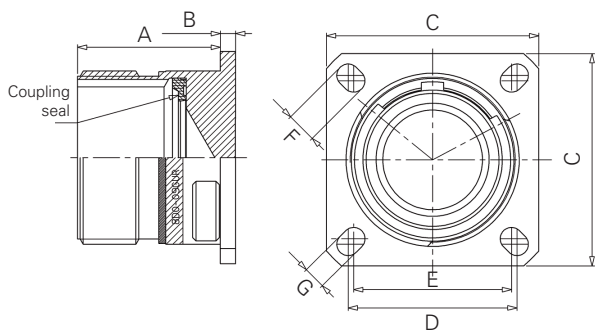

Shell size	Part number	A Max	B Max	C ^{+0.30}	D	E	F ^{+0.20}	G ^{+0.20}
09	8D0-09 • UR	20.90	2.50	23.80	18.26	15.09	4.49	3.25
11	8D0-11 • UR	20.90	2.50	26.20	20.62	18.26	4.93	3.25
13	8D0-13 • UR	20.90	2.50	28.60	23.01	20.62	4.93	3.25
15	8D0-15 • UR	20.90	2.50	31.00	24.61	23.01	4.93	3.25
17	8D0-17 • UR	20.90	2.50	33.30	26.97	24.61	4.93	3.25
19	8D0-19 • UR	20.90	2.50	36.50	26.97	24.61	4.93	3.25
21	8D0-21 • UR	20.10	3.20	39.70	31.75	29.36	4.93	3.25
23	8D0-23 • UR	20.10	3.20	42.90	34.93	31.75	6.15	3.91
25	8D0-25 • UR	20.10	3.20	46.00	38.10	34.93	6.15	3.91

•: "G" for olive green cadmium; "F" for nickel.

Note: All dimensions are in millimeters (mm).

Souriau 8D series - aluminum

Dimensions

PC tail contacts lengths

	Contact size	Contact type	PC tail type	Shell size										
				09 (A)	11 (B)	13 (C)	15 (D)	17 (E)	19 (F)	21 (G)	23 (H)	25 (J)		
ØA	#22D	M & F	Max	L & C	0.70	0.70	0.70	0.70	0.70	0.70	0.70	0.70	0.70	
		M & F	Max	S	0.50	0.50	0.50	0.50	0.50	0.50	0.50	0.50	0.50	
	#20	M & F	Max	C	0.70	0.70	0.70	0.70	0.70	0.70	0.70	0.70		
	#16	M & F	Max	C	1.15	1.15	1.15	1.15	1.15	1.15	1.15	1.15		
	#12	M & F	Max	C	2.05	2.05	2.05	2.05	2.05	2.05	2.05	2.05		
	L1	#22D	M	Min	L & C	10.52	10.52	10.34	10.34	10.34	10.34	10.34	10.34	10.34
			M	Max	L & C	11.46	11.46	11.28	11.28	11.28	11.28	11.28	11.28	11.28
		F	Min	L & C	10.19	10.19	10.01	10.01	10.01	10.01	10.01	10.01	10.01	
		F	Max	L & C	11.46	11.46	11.28	11.28	11.28	11.28	11.28	11.28	11.28	
		M	Min	S	10.19	10.19	10.01	10.01	10.01	10.01	10.01	10.01	10.01	
		M	Max	S	11.46	11.46	11.28	11.28	11.28	11.28	11.28	11.28	11.28	
		F	Min	S	10.69	10.69	10.51	10.51	10.51	10.51	10.51	10.51	10.51	
F		Max	S	11.63	11.63	11.45	11.45	11.45	11.45	11.45	11.45	11.45		
#20		M	Min	C	10.36	10.36	10.18	10.18	10.18	10.18	10.18	10.18	10.18	
		M	Max	C	11.63	11.63	11.45	11.45	11.45	11.45	11.45	11.45	11.45	
		F	Min	C	10.69	10.69	10.51	10.51	10.51	10.51	10.51	10.51	10.51	
		F	Max	C	11.63	11.63	11.45	11.45	11.45	11.45	11.45	11.45	11.45	
#16		M	Min	C	10.69	10.69	10.51	10.51	10.51	10.51	10.51	10.51	10.51	
		M	Max	C	11.63	11.63	11.45	11.45	11.45	11.45	11.45	11.45	11.45	
		F	Min	C	10.69	10.69	10.51	10.51	10.51	10.51	10.51	10.51	10.51	
		F	Max	C	11.63	11.63	11.45	11.45	11.45	11.45	11.45	11.45	11.45	
#12		M	Min	C	10.63	10.63	10.45	10.45	10.45	10.45	10.45	10.45	10.45	
		M	Max	C	11.56	11.56	11.38	11.38	11.38	11.38	11.38	11.38	11.38	
		F	Min	C	10.63	10.63	10.45	10.45	10.45	10.45	10.45	10.45	10.45	
		F	Max	C	11.56	11.56	11.38	11.38	11.38	11.38	11.38	11.38	11.38	
L2		#22D	M & F	Max	L	8.50	8.50	8.50	8.50	8.50	8.50	8.50	8.50	
			M & F	Max	C	4.00	4.00	4.00	4.00	4.00	4.00	4.00	4.00	
			M & F	Max	S	5.10	5.10	5.10	5.10	5.10	5.10	5.10	5.10	
		#20	M & F	Max	C	5.10	5.10	5.10	5.10	5.10	5.10	5.10	5.10	
	#16	M & F	Max	C	5.10	5.10	5.10	5.10	5.10	5.10	5.10	5.10		
	#12	M & F	Max	C	5.10	5.10	5.10	5.10	5.10	5.10	5.10	5.10		
	L3	#22D	M	Min	L & C	9.48	9.48	9.48	9.48	9.48	9.48	9.59	9.59	9.59
			M	Max	L & C	10.58	10.58	10.58	10.58	10.58	10.58	10.69	10.69	10.69
			F	Min	L & C	9.15	9.15	9.15	9.15	9.15	9.15	9.26	9.26	9.26
F			Max	L & C	10.58	10.58	10.58	10.58	10.58	10.58	10.69	10.69	10.69	
M		Min	S	9.65	9.65	9.65	9.65	9.65	9.65	9.76	9.76	9.76		
M		Max	S	10.75	10.75	10.75	10.75	10.75	10.75	10.86	10.86	10.86		
F		Min	S	9.15	9.15	9.15	9.15	9.15	9.15	9.26	9.26	9.26		
F		Max	S	10.75	10.75	10.75	10.75	10.75	10.75	10.86	10.86	10.86		
#20		M	Min	C	9.65	9.65	9.65	9.65	9.65	9.65	9.76	9.76	9.76	
		M	Max	C	10.75	10.75	10.75	10.75	10.75	10.75	10.86	10.86	10.86	
		F	Min	C	9.65	9.65	9.65	9.65	9.65	9.65	9.76	9.76	9.76	
		F	Max	C	10.75	10.75	10.75	10.75	10.75	10.75	10.86	10.86	10.86	
#16		M	Min	C	9.64	9.64	9.64	9.64	9.64	9.64	9.75	9.75	9.75	
		M	Max	C	10.75	10.75	10.75	10.75	10.75	10.75	10.86	10.86	10.86	
		F	Min	C	9.64	9.64	9.64	9.64	9.64	9.64	9.75	9.75	9.75	
		F	Max	C	10.75	10.75	10.75	10.75	10.75	10.75	10.86	10.86	10.86	
#12		M	Min	C	10.25	10.25	10.25	10.25	10.25	10.25	9.95	9.95	9.95	
		M	Max	C	11.21	11.21	11.21	11.21	11.21	11.21	10.91	10.91	10.91	
		F	Min	C	10.25	10.25	10.25	10.25	10.25	10.25	9.95	9.95	9.95	
		F	Max	C	11.21	11.21	11.21	11.21	11.21	11.21	10.91	10.91	10.91	

M: Male contact
F: Female contact

L: Long PC tail
C: Short PC tail
S: Specific PC tail

Receptacle type 7

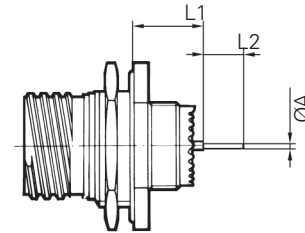

Receptacle type 0

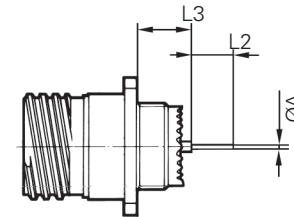

Note: All dimensions are in millimeters (mm).

Connector weight - in grams ($\pm 15\%$)

Shell size & layout		With contacts						Without contacts					
		Plug (type 5)		Receptacle (type 0)		Receptacle (type 7)		Plug (type 5)		Receptacle (type 0)		Receptacle (type 7)	
		Male	Female	Male	Female	Male	Female	Male	Female	Male	Female	Male	Female
09	35	12.17	13.75	8.87	10.45	13.01	14.59	11.75	12.25	8.45	8.95	12.59	13.09
	98	12.17	13.47	8.87	10.17	13.01	14.31	11.75	12.27	8.45	8.97	12.59	13.11
11	01	16.14	19.08	12.08	15.02	16.94	19.88	15.48	17.48	11.42	13.42	16.28	18.28
	02	15.87	18.33	11.81	14.27	16.67	19.13	15.25	16.77	11.19	12.71	16.05	17.57
	04	15.96	19.02	11.90	14.96	16.76	19.82	15.40	17.42	11.34	13.36	16.20	18.22
	05	15.99	19.20	11.93	15.14	16.79	20.00	15.29	17.20	11.23	13.14	16.09	18.00
	22	15.61	17.97	11.55	13.91	16.41	18.77	15.33	16.97	11.27	12.91	16.13	17.77
	35	15.89	19.36	11.83	15.30	16.69	20.16	14.98	16.11	10.92	12.05	15.78	16.91
	80	19.12	22.50	15.06	18.44	19.92	23.30	14.62	15.50	10.56	11.44	15.42	16.30
	98	15.86	18.62	11.80	14.56	16.66	19.42	15.02	16.22	10.96	12.16	15.82	17.02
	99	15.99	19.07	11.93	15.01	16.79	19.87	15.01	16.27	10.95	12.21	15.81	17.07
	13	04	22.60	26.38	15.51	19.29	22.72	26.50	21.36	23.26	14.27	16.17	21.48
08		22.98	28.16	15.89	21.07	23.10	28.28	21.86	24.96	14.77	17.87	21.98	25.08
26		23.35	29.00	16.26	21.91	23.47	29.12	21.61	24.30	14.52	17.21	21.73	24.42
35		22.78	28.55	15.69	21.46	22.90	28.67	21.24	23.05	14.15	15.96	21.36	23.17
98		22.64	27.26	15.55	20.17	22.76	27.38	21.24	23.26	14.15	16.17	21.36	23.38
15	05	27.94	33.28	19.26	24.60	27.58	32.92	26.39	29.38	17.71	20.70	26.03	29.02
	15	28.74	35.90	20.06	27.22	28.38	35.54	26.47	29.52	17.79	20.84	26.11	29.16
	18	28.95	37.83	20.27	29.15	28.59	37.47	26.43	30.63	17.75	21.95	26.07	30.27
	19	28.48	36.21	19.80	27.53	28.12	35.85	25.82	28.61	17.14	19.93	25.46	28.25
	35	28.58	37.82	19.90	29.14	28.22	37.46	25.99	28.57	17.31	19.89	25.63	28.21
	97	28.41	35.46	19.73	26.78	28.05	35.10	26.05	29.14	17.37	20.46	25.69	28.78
	17	02	35.28	48.52	30.70	43.94	39.52	52.76	28.12	32.02	23.54	27.44	32.36
06		32.67	42.27	28.09	37.69	36.91	46.51	28.71	32.67	24.13	28.09	32.95	36.91
08		31.66	40.39	27.08	35.81	35.90	44.63	29.18	34.15	24.60	29.57	33.42	38.39
26		32.24	43.03	27.66	38.45	36.48	47.27	28.60	32.63	24.02	28.05	32.84	36.87
35		32.48	46.03	27.90	41.45	36.72	50.27	28.63	32.28	24.05	27.70	32.87	36.52
75		38.08	49.37	33.50	44.79	42.32	53.61	29.08	35.37	24.50	30.79	33.32	39.61
99		32.29	42.85	27.71	38.27	36.53	47.09	28.73	32.89	24.15	28.31	32.97	37.13
19		11	40.22	53.81	30.81	44.40	43.13	56.72	36.81	45.23	27.40	35.82	39.72
	32	39.43	52.83	30.02	43.42	42.34	55.74	34.95	40.03	25.54	30.62	37.86	42.94
	35	39.74	56.19	30.33	46.78	42.65	59.10	35.12	39.69	25.71	30.28	38.03	42.60
21	11	48.37	68.21	39.21	59.05	51.74	71.58	41.11	50.61	31.95	41.45	44.48	53.98
	16	45.47	60.75	36.31	51.59	48.84	64.12	40.51	48.27	31.35	39.11	43.88	51.64
	35	45.75	66.41	36.59	57.25	49.12	69.78	40.22	46.66	31.06	37.50	43.59	50.03
	39	47.13	67.46	37.97	58.30	50.50	70.83	41.33	51.10	32.17	41.94	44.70	54.47
	41	45.67	63.04	36.51	53.88	49.04	66.41	39.93	46.64	30.77	37.48	43.30	50.01
	48	53.51	72.78	44.35	63.62	56.88	76.15	39.47	45.86	30.31	36.70	42.84	49.23
	75	57.09	73.76	47.93	64.60	60.46	77.13	39.09	45.76	29.93	36.60	42.46	49.13
23	21	53.69	76.94	44.21	67.46	58.09	81.34	47.18	60.56	37.70	51.08	51.58	64.96
	35	52.05	78.20	42.57	68.72	56.45	82.60	45.05	53.20	35.57	43.72	49.45	57.60
	53	52.11	74.30	42.63	64.82	56.51	78.70	44.69	53.10	35.21	43.62	49.09	57.50
	55	52.86	75.93	43.38	66.45	57.26	80.33	45.16	53.93	35.68	44.45	49.56	58.33
25	25-04	62.45	92.30	52.33	82.18	67.17	97.02	53.25	66.86	43.13	56.74	57.97	71.58
	25-07	65.99	98.32	55.87	88.20	70.71	103.04	50.20	60.07	40.08	49.95	54.92	64.79
	25-08	85.03	116.86	74.91	106.74	89.75	121.58	49.03	60.86	38.91	50.74	53.75	65.58
	25-11	66.05	90.02	55.93	79.90	70.77	94.74	52.63	66.72	42.51	56.60	57.35	71.44
	25-19	63.79	95.80	53.67	85.68	68.51	100.52	51.25	65.40	41.13	55.28	55.97	70.12
	25-20	70.05	100.27	59.93	90.15	74.77	104.99	48.48	58.73	38.36	48.61	53.20	63.45
	25-24	63.29	94.65	53.17	84.53	68.01	99.37	51.65	66.09	41.53	55.97	56.37	70.81
	25-29	61.61	90.58	51.49	80.46	66.33	95.30	52.62	67.96	42.50	57.84	57.34	72.68
	25-35	59.40	92.23	49.28	82.11	64.12	96.95	50.44	60.23	40.32	50.11	55.16	64.95
	25-37	62.43	92.04	52.31	81.92	67.15	96.76	50.96	63.18	40.84	53.06	55.68	67.90
	25-43	61.65	92.33	51.53	82.21	66.37	97.05	52.23	67.53	42.11	57.41	56.95	72.25
	25-44	79.87	110.76	69.75	100.64	84.59	115.48	48.79	61.08	38.67	50.96	53.51	65.80
	25-46	65.73	89.57	55.61	79.45	70.45	94.29	49.31	59.47	39.19	49.35	54.03	64.19
	25-61	58.70	85.45	48.58	75.33	63.42	90.17	50.16	61.05	40.04	50.93	54.88	65.77

Souriau 8D series - aluminum

Backshells

Souriau aluminum backshells part numbers

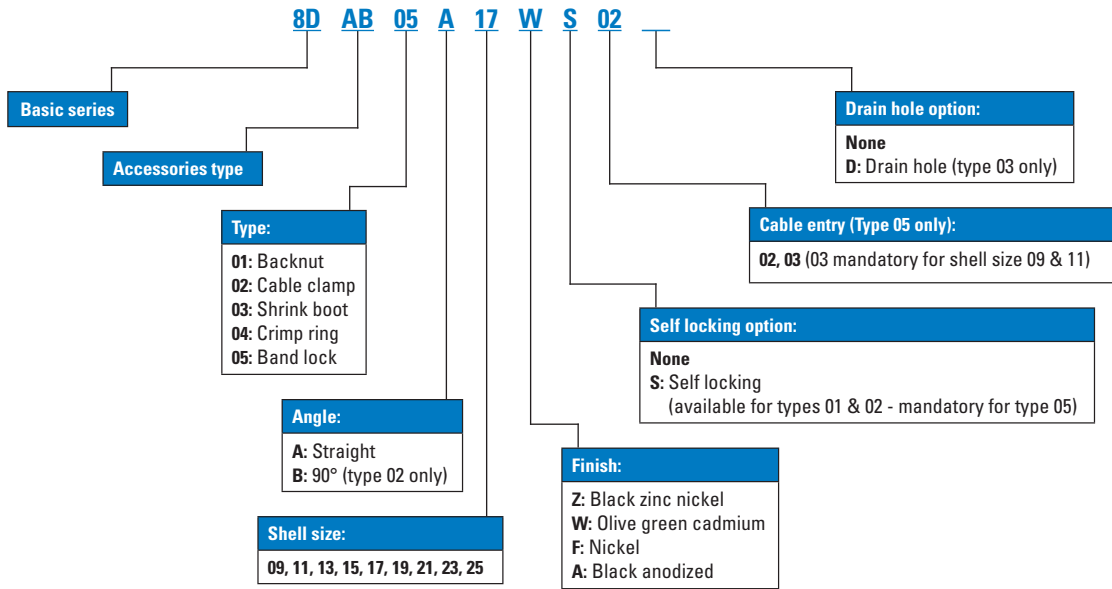

Dimensions

Aluminum backshell type 01 - backnut

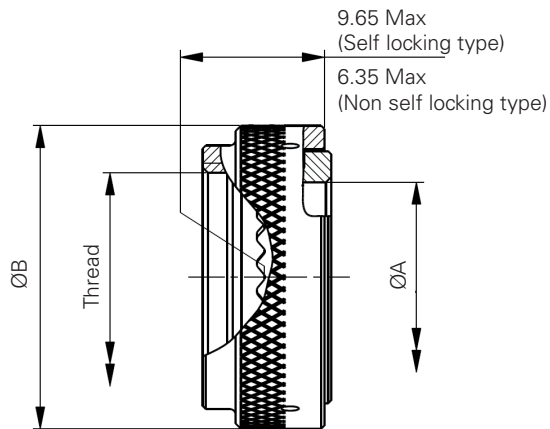

Shell size	ØA Min	ØB Max
09	6.7	17.9
11	9.95	20.9
13	12.85	24.3
15	17.0	27.9
17	19.25	31.3
19	21.7	35.3
21	24.7	38.1
23	27.8	41.5
25	32.0	44.5

Thread: See Page 27 for information.

Note: All dimensions are in millimeters (mm).

Souriau aluminum backshells

Aluminum backshell type 02 - cable clamp

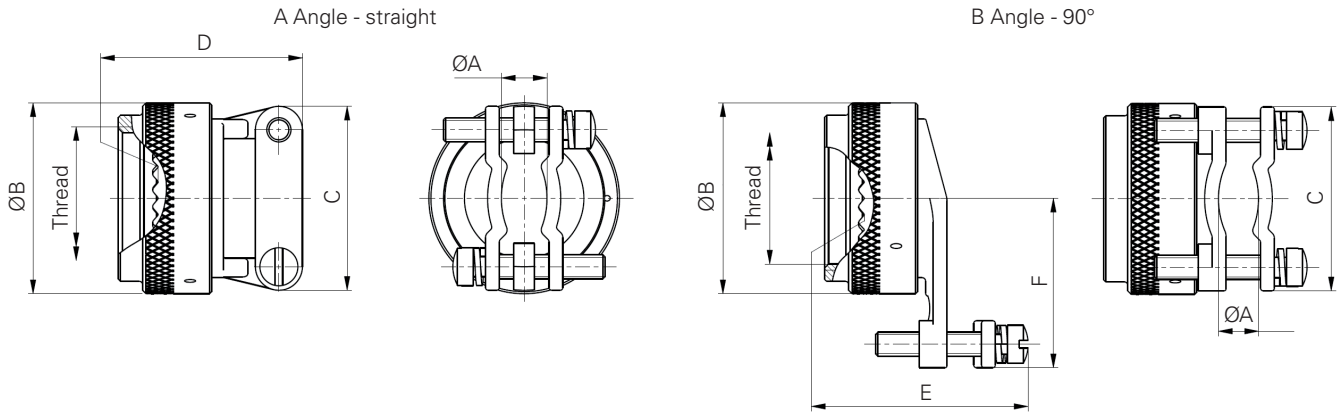

Shell size	ØA Min	ØA Max	ØB Max	C Max	D Max	E Max	F Max
09	2.49	5.94	17.9	21.5	23.1	29.5	20
11	3.89	5.94	20.9	21.5	23.1	29.5	21.5
13	4.83	8.33	24.3	24.5	25.6	31.5	23.5
15	6.60	11.61	27.9	27.5	26.9	35.8	25.5
17	7.19	15.6	31.3	31.5	29.4	40.1	27.5
19	8.26	16.1	35.3	35.5	35.8	40.6	30.5
21	8.71	17.73	38.1	37	38.3	42.7	31.5
23	9.68	20.9	41.5	40.5	42.1	46.2	34.5
25	10.62	21.67	44.5	45	44.7	49	36.5

Thread: See Page 27 for information.

Aluminum backshell type 03 - shrink boot

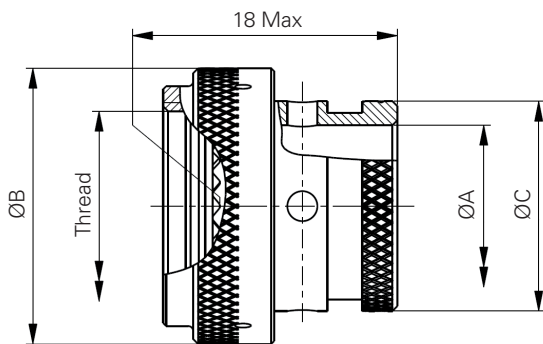

Shell size	ØA Min	ØB Max	C Max
09	6.7	19.0	11.3
11	9.95	21.5	14.9
13	12.85	25.3	17.8
15	16.05	29.1	21.27
17	19.2	31.7	24.3
19	21.5	35.5	26.4
21	24.7	39.3	30.8
23	27.8	41.8	34.1
25	31	46.9	36.6

Thread: See Page 27 for information.

Note: All dimensions are in millimeters (mm).

Souriau 8D series - aluminum

Backshells

Souriau aluminum backshells

Aluminum backshell type 04 - crimp ring

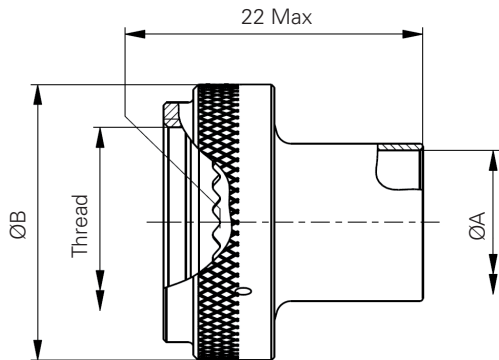

Shell size	ØA Min	ØB Max
09	6	17.9
11	8.2	20.9
13	10.5	24.3
15	13.6	27.9
17	16.9	31.3
19	20	34.3
21	23.2	38.1
23	26.1	41.5
25	28.1	44.4

Thread: See below for information.

Aluminum backshell type 05 - band lock

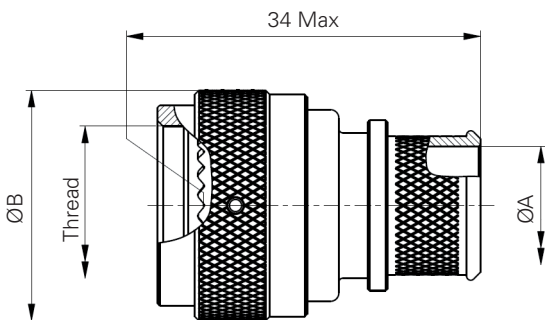

Shell size	ØA Max - entry size		ØB Max
	02	03	
09	-	6.6	17.9
11	-	8	24.9
13	8	11.2	29.3
15	11.2	14.4	32.4
17	12.8	16	35.6
19	16	19.1	38.4
21	16	20.7	41.6
23	17.6	23.9	44.8
25	19.1	25.5	47.9

Thread: See below for information.

Recommended installation torque

Shell Size	Installation torque (inch-pounds)
09, 11, 13, 15, 17 & 19	40
21, 23 & 25	80

Note: Torque values are based on 80% of the coupling thread strength specified in SAE-AS85049 standard.

Thread information

Shell size	Metric thread
09	M12x1.0-6H-0.10R
11	M15x1.0-6H-0.10R
13	M18x1.0-6H-0.10R
15	M22x1.0-6H-0.10R
17	M25x1.0-6H-0.10R
19	M28x1.0-6H-0.10R
21	M31x1.0-6H-0.10R
23	M34x1.0-6H-0.10R
25	M37x1.0-6H-0.10R

Note: All dimensions are in millimeters (mm).

M85049 aluminum backshells

Backshells - cable clamp

Straight cable clamp (type 38)

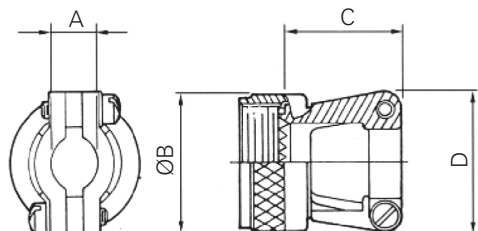

90° cable clamp (type 39)

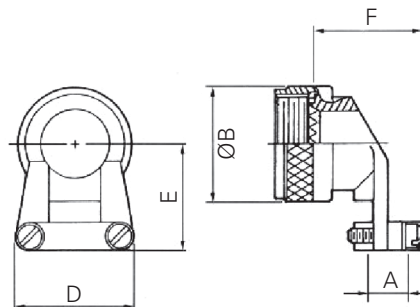

Shell size	A Min	A Max	ØB Max	C Max	D Max	E Max	F Max
09	2.50	5.90	21.80	23.10	21.60	25.40	25.70
11	3.90	5.90	25.00	23.10	22.90	27.90	25.70
13	4.80	8.30	29.40	25.70	27.90	27.90	30.70
15	6.60	11.60	32.50	26.90	29.20	31.80	32.00
17	7.20	15.60	35.70	29.50	33.00	33.00	35.80
19	8.30	16.10	38.50	35.80	38.10	34.30	38.40
21	8.70	17.70	41.70	38.40	40.60	40.60	42.20
23	9.70	20.90	44.90	42.20	43.20	44.50	44.70
25	10.60	21.70	48.00	44.70	45.70	47.00	48.50

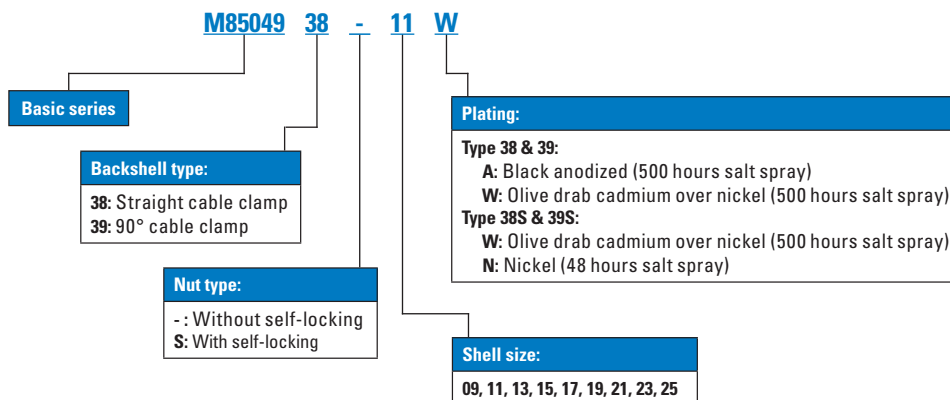

Note: All dimensions are in millimeters (mm).

Souriau 8D series - aluminum

Backshells

M85049 aluminum backshells

Backshells for heat shrink boots

Backshell for heat shrink boots (type 69)

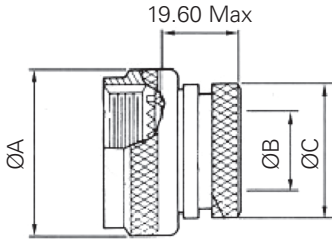

Shell size	ØA Max	ØB Max	ØC Max
09	19.10	6.35	13.55
11	21.60	9.50	15.40
13	25.40	12.70	19.70
15	29.20	15.90	21.30
17	31.80	19.00	24.50
19	35.60	20.60	26.50
21	39.40	23.80	30.90
23	41.90	27.00	34.40
25	47.00	30.20	36.65

Straight backshell for EMI/RFI heat shrink boots (type 88)

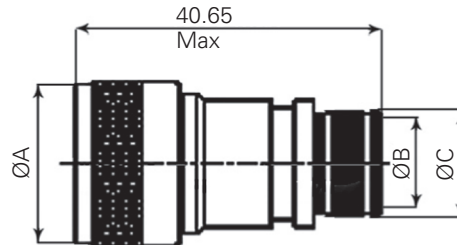

Shell size	ØA Max	ØB ^{±0.10} Entry size		ØC	
		02	03	02	03
09	21.79	-	6.35	-	10.03
11	24.99	-	7.92	-	11.61
13	29.39	7.92	11.13	11.61	14.81
15	32.49	11.13	14.27	14.81	17.96
17	35.71	12.70	15.88	16.38	19.56
19	38.51	15.88	19.05	19.56	22.73
21	41.71	15.88	20.62	19.56	24.30
23	44.91	17.47	23.83	21.06	27.51
25	47.98	19.05	25.40	22.73	29.08

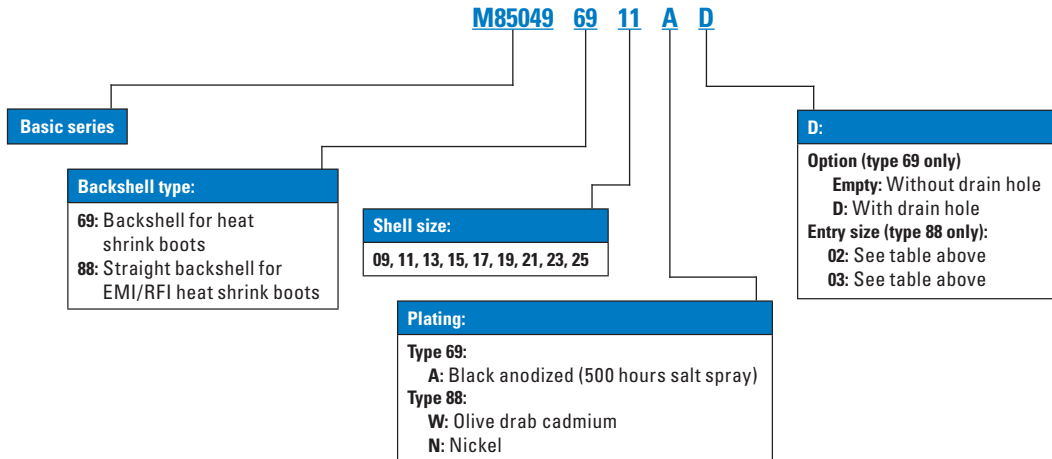

Note: All dimensions are in millimeters (mm).

M85049 aluminum backshells

Backshell for screen termination and cable clamp (type 19)

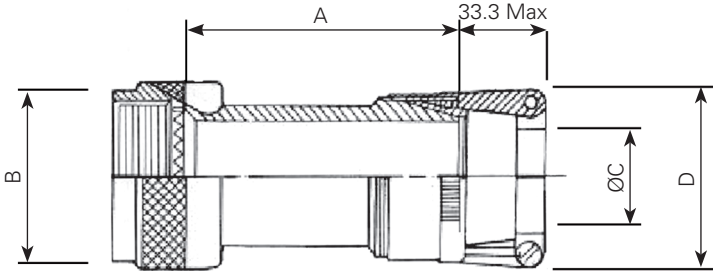

Shell size	A Max	B Max	Clamp indicator base on shell size
09	38.10	19.10	01 - 02
11	38.10	21.60	01 - 02 - 03
13	38.10	25.40	02 - 03 - 04
15	38.10	27.90	02 - 03 - 04 - 05
17	38.10	31.80	02 - 03 - 04 - 05 - 06
19	38.10	35.60	03 - 04 - 05 - 06 - 07
21	38.10	38.10	03 - 04 - 05 - 06 - 07 - 08
23	38.10	41.90	03 - 04 - 05 - 06 - 07 - 08
25	38.10	44.50	04 - 05 - 06 - 07 - 08 - 10

Clamp size indicator	C Min	C Max	D
01	1.60	3.20	20.30
02	3.20	6.35	25.40
03	6.35	9.50	27.90
04	7.90	12.70	30.50
05	11.10	15.90	31.80
06	14.30	19.00	35.60
07	17.45	22.20	38.10
08	20.60	24.40	41.90
09	23.80	28.60	44.50
10	27.00	31.75	48.30

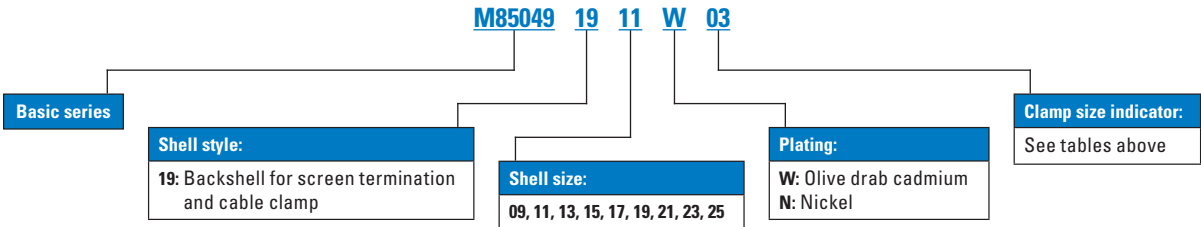

Band-it

	Flat stainless steel standard band	Pre-coiled stainless steel standard band	Hand banding tool
Part number	M85049/128-3	M85049/128-4	8599-9346

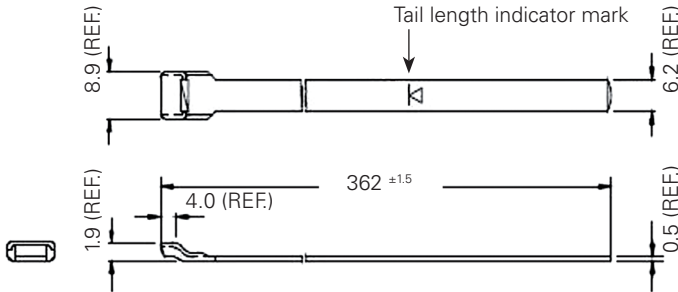

Note: All dimensions are in millimeters (mm).

Souriau 8D series - aluminum

Aluminum caps

Aluminum caps

Souriau part number

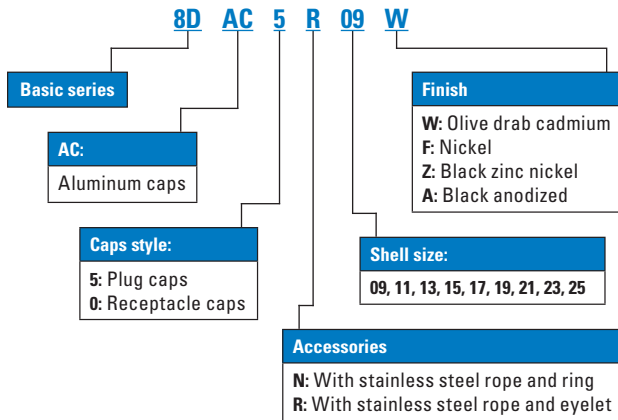

MIL-DTL-38999 part number

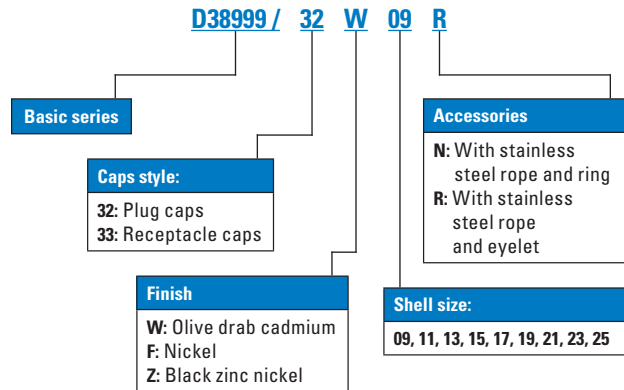

Dimensions

Aluminum caps with stainless steel rope

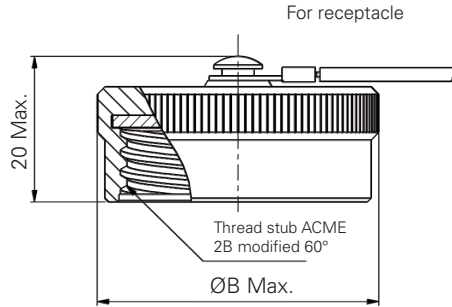
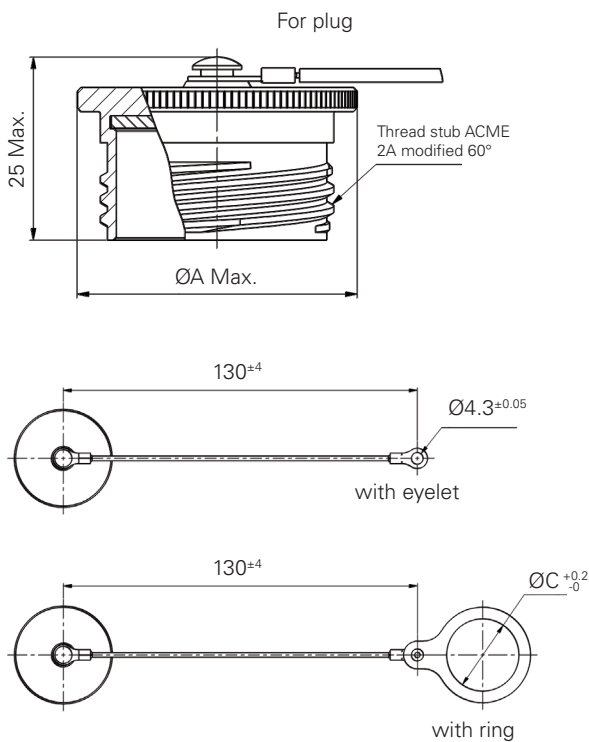

Size	ØA	ØB	ØC for plug	ØC for receptacle	Thread
09	22.6	22.8	15	18.4	0.6250-0.1P-0.3L-TS
11	25.8	26.5	18.4	23.2	0.7500-0.1P-0.3L-TS
13	30	30	23.2	26.5	0.8750-0.1P-0.3L-TS
15	33	31.8	23.2	30.3	1.0000-0.1P-0.3L-TS
17	36.5	36.8	26.5	32.6	1.1875-0.1P-0.3L-TS
19	39.2	38.8	30.3	36.5	1.2500-0.1P-0.3L-TS
21	42.5	41.8	32.6	39.3	1.3750-0.1P-0.3L-TS
23	45.8	44.8	36.5	42.9	1.5000-0.1P-0.3L-TS
25	48.9	48.8	39.3	45	1.6250-0.1P-0.3L-TS

Note: All dimensions are in millimeters (mm).

Connector part numbers

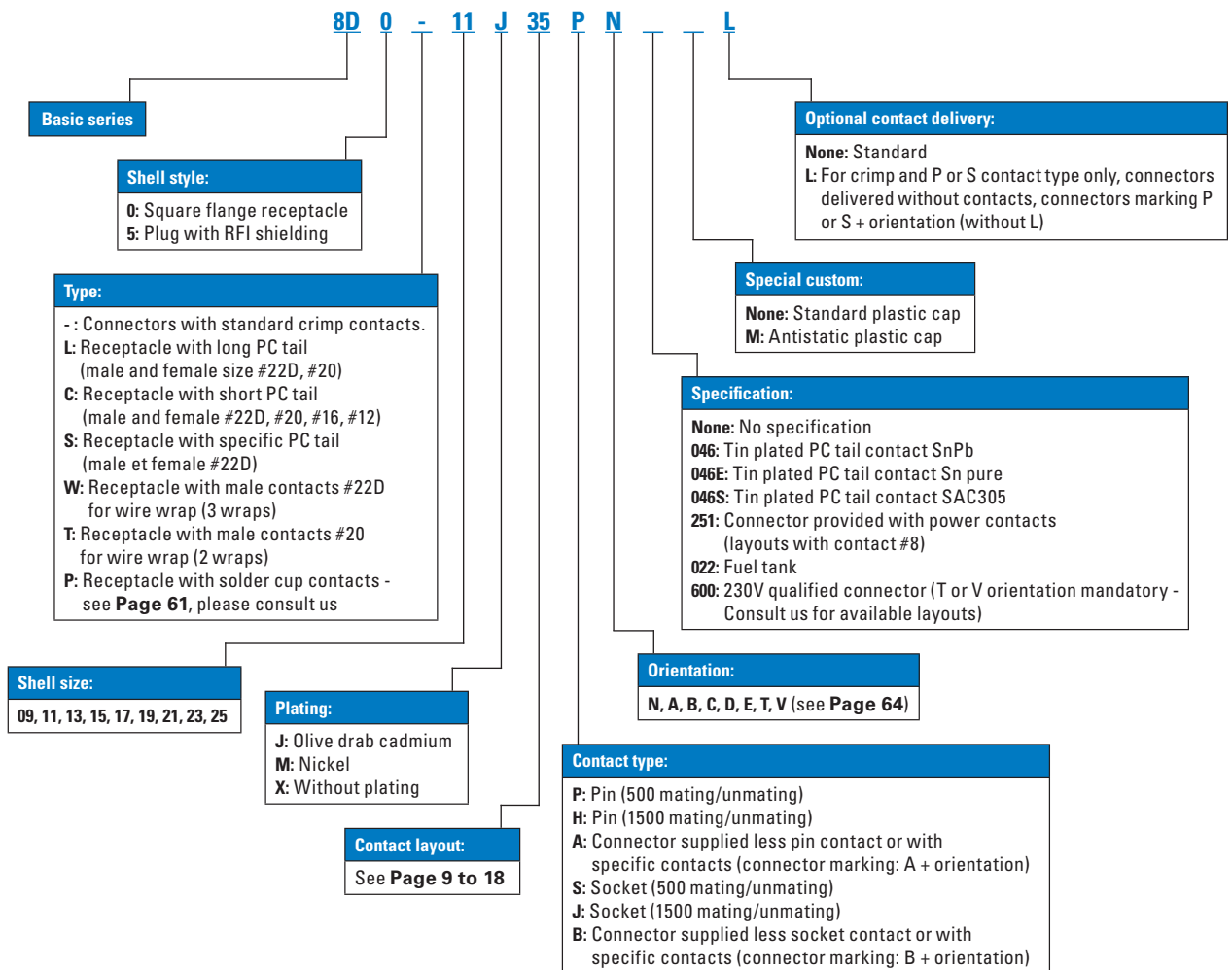

Note: PC tail contacts without shoulder also available. Please see Page 119.

BACC part numbers

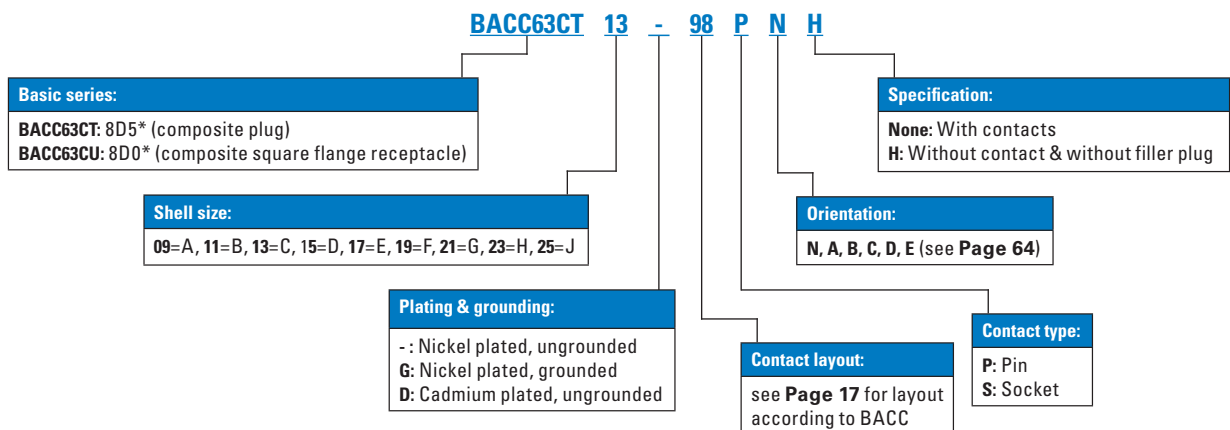

Souriau 8D series - composite

Part numbers

MIL-DTL-38999 part numbers

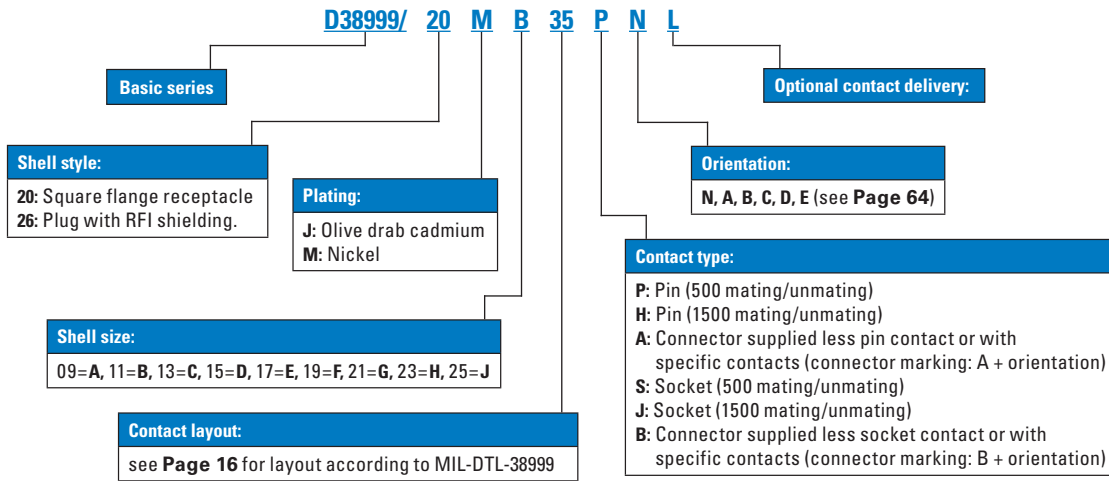

Note: To place an order of MIL connectors delivered without MIL removable crimp contacts and keep P or S plus orientation marking, it must be clearly specified on the order (by adding a suffix L at the end of the P/N or specified in comment).

Delivered with MIL contacts mandatory.

As stated in MIL-DTL-38999 standard, insert arrangements using multi-axial contacts (i.e. coax, twinax, quadax) should not be used in firewall applications.

EN3645 part numbers

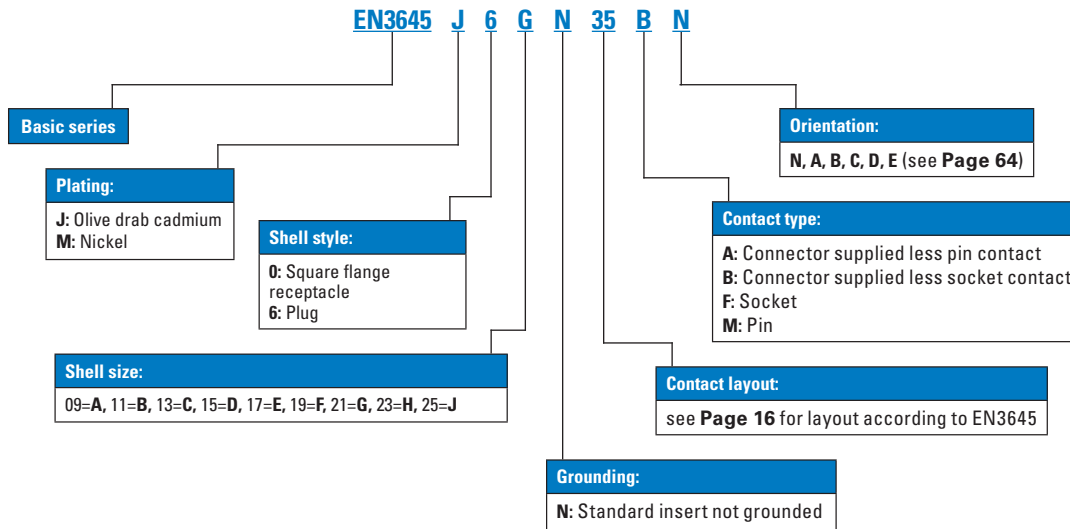

Dimensions

Receptacle type 0

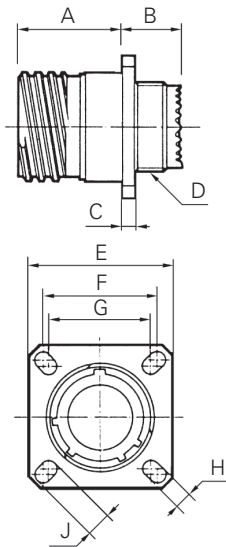

Shell size	A Max	B Max	C Max	D Thread	E ^{+0.3}	F	G	H ^{+0.2}	J ^{+0.2}
09 (A)	19.65	11.96	3.65	M12 x 1-6g	23.8	18.26	15.09	3.25	5.49
11 (B)	19.65	11.96	3.65	M15 x 1-6g	26.2	20.62	18.26	3.25	4.93
13 (C)	19.65	11.96	3.65	M18 x 1-6g	28.6	23.01	20.62	3.25	4.93
15 (D)	19.65	11.96	3.65	M22 x 1-6g	31	24.61	23.01	3.25	4.39
17 (E)	19.65	11.96	3.65	M25 x 1-6g	33.3	26.97	24.61	3.25	4.93
19 (F)	19.65	11.96	3.65	M28 x 1-6g	36.5	29.36	26.97	3.25	4.93
21 (G)	18.85	12.76	4.35	M31 x 1-6g	39.7	31.75	29.36	3.25	4.93
23 (H)	18.85	12.76	4.35	M34 x 1-6g	42.9	34.93	31.75	3.91	6.15
25 (J)	18.85	12.76	4.35	M37 x 1-6g	46	38.1	34.93	3.91	6.15

Plug type 5

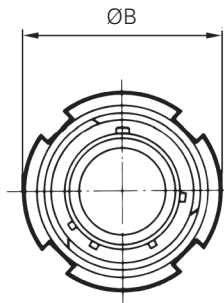
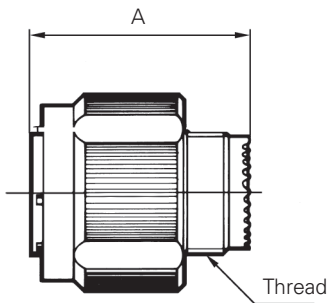

Shell size	A Max	Thread	ØB Max
09 (A)	31.00	M12 x 1-6g	21.80
11 (B)	31.00	M15 x 1-6g	25.00
13 (C)	31.00	M18 x 1-6g	29.40
15 (D)	31.00	M22 x 1-6g	32.50
17 (E)	31.00	M25 x 1-6g	35.70
19 (F)	31.00	M28 x 1-6g	38.50
21 (G)	31.00	M31 x 1-6g	41.70
23 (H)	31.00	M34 x 1-6g	44.90
25 (J)	31.00	M37 x 1-6g	48.00

Mated connectors

Type 0 with plug

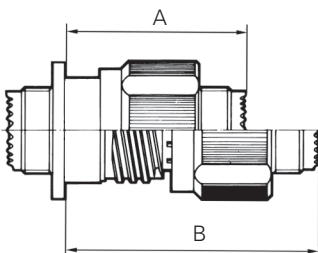

Shell size	A Max	B Max
09 (A)	37.00	52.30
11 (B)	37.00	52.30
13 (C)	37.00	52.30
15 (D)	37.00	52.30
17 (E)	37.00	52.30
19 (F)	37.00	52.30
21 (G)	36.00	51.30
23 (H)	36.00	51.30
25 (J)	36.00	51.30

Note: All dimensions are in millimeters (mm).

Souriau 8D series - composite

PC tail contact lengths

PC tail contacts lengths

	Contact size	Contact type	PC tail type	Shell size									
				09 (A)	11 (B)	13 (C)	15 (C)	17 (E)	19 (F)	21 (G)	23 (H)	25 (J)	
0A	#22D	M & F	Max	L & C	0.70	0.70	0.70	0.70	0.70	0.70	0.70	0.70	0.70
		M & F	Max	S	0.50	0.50	0.50	0.50	0.50	0.50	0.50	0.50	0.50
	#20	M & F	Max	C	0.70	0.70	0.70	0.70	0.70	0.70	0.70	0.70	0.70
	#16	M & F	Max	C	1.15	1.15	1.15	1.15	1.15	1.15	1.15	1.15	1.15
	#12	M & F	Max	C	2.05	2.05	2.05	2.05	2.05	2.05	2.05	2.05	2.05
L1	#22D	M & F	Max	L	8.50	8.50	8.50	8.50	8.50	8.50	8.50	8.50	8.50
		M & F	Max	C	4.00	4.00	4.00	4.00	4.00	4.00	4.00	4.00	4.00
		M & F	Max	S	5.10	5.10	5.10	5.10	5.10	5.10	5.10	5.10	5.10
	#20	M & F	Max	C	5.10	5.10	5.10	5.10	5.10	5.10	5.10	5.10	5.10
	#16	M & F	Max	C	5.10	5.10	5.10	5.10	5.10	5.10	5.10	5.10	5.10
	#12	M & F	Max	C	5.10	5.10	5.10	5.10	5.10	5.10	5.10	5.10	5.10
L2	#22D	M	Min	L & C	9.48	9.48	9.48	9.48	9.48	9.48	9.59	9.59	9.59
		M	Max	L & C	10.38	10.38	10.38	10.38	10.38	10.38	10.48	10.48	10.48
		F	Min	L & C	9.15	9.15	9.15	9.15	9.15	9.15	9.26	9.26	9.26
		F	Max	L & C	10.38	10.38	10.38	10.38	10.38	10.38	10.48	10.48	10.48
		M	Min	S	9.65	9.65	9.65	9.65	9.65	9.65	9.76	9.76	9.76
		M	Max	S	10.55	10.55	10.55	10.55	10.55	10.55	10.65	10.65	10.65
		F	Min	S	9.32	9.32	9.32	9.32	9.32	9.32	9.42	9.42	9.42
		F	Max	S	10.55	10.55	10.55	10.55	10.55	10.55	10.65	10.65	10.65
	#20	M	Min	C	9.65	9.65	9.65	9.65	9.65	9.65	9.76	9.76	9.76
		M	Max	C	10.55	10.55	10.55	10.55	10.55	10.55	10.65	10.65	10.65
		F	Min	C	9.65	9.65	9.65	9.65	9.65	9.65	9.76	9.76	9.76
		F	Max	C	10.55	10.55	10.55	10.55	10.55	10.55	10.65	10.65	10.65
	#16	M	Min	C	9.65	9.65	9.65	9.65	9.65	9.65	9.76	9.76	9.76
		M	Max	C	10.55	10.55	10.55	10.55	10.55	10.55	10.65	10.65	10.65
		F	Min	C	9.65	9.65	9.65	9.65	9.65	9.65	9.76	9.76	9.76
		F	Max	C	10.55	10.55	10.55	10.55	10.55	10.55	10.65	10.65	10.65
	#12	M	Min	C	9.66	9.66	9.66	9.66	9.66	9.66	9.76	9.76	9.76
		M	Max	C	10.53	10.53	10.53	10.53	10.53	10.53	10.63	10.63	10.63
		F	Min	C	9.66	9.66	9.66	9.66	9.66	9.66	9.76	9.76	9.76
		F	Max	C	10.53	10.53	10.53	10.53	10.53	10.53	10.63	10.63	10.63

M: Male contact
F: Female contact

L: Long PC tail
C: Short PC tail
S: Specific PC tail

Receptacle type 0

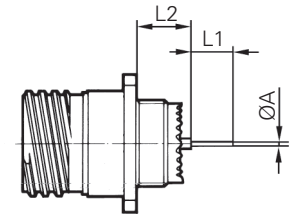

Note: All dimensions are in millimeters (mm).

Connector weight - in grams ($\pm 15\%$)

Shell size & Layout		With contacts				Without contacts			
		Plug (type 5)		Receptacle (type 0)		Plug (type 5)		Receptacle (type 0)	
		Male	Female	Male	Female	Male	Female	Male	Female
09	35	8.46	10.04	7.81	9.39	8.04	8.54	7.39	7.89
	98	8.46	9.76	7.81	9.11	8.04	8.56	7.39	7.91
11	01	12.78	15.72	10.39	13.33	12.12	14.12	9.73	11.73
	02	12.51	14.97	10.12	12.58	11.89	13.41	9.50	11.02
	04	12.60	15.66	10.21	13.27	12.04	14.06	9.65	11.67
	05	12.63	15.84	10.24	13.45	11.93	13.84	9.54	11.45
	22	12.25	14.61	9.86	12.22	11.97	13.61	9.58	11.22
	35	12.53	16.00	10.14	13.61	11.62	12.75	9.23	10.36
	80	15.76	19.14	13.37	16.75	11.26	12.14	8.87	9.75
	98	12.50	15.26	10.11	12.87	11.66	12.86	9.27	10.47
	99	12.63	15.71	10.24	13.32	11.65	12.91	9.26	10.52
13	04	17.19	20.97	13.66	17.44	15.95	17.85	12.42	14.32
	08	17.57	22.75	14.04	19.22	16.45	19.55	12.92	16.02
	26	17.94	23.59	14.41	20.06	16.20	18.89	12.67	15.36
	35	17.37	23.14	13.84	19.61	15.83	17.64	12.30	14.11
	98	17.23	21.85	13.70	18.32	15.83	17.85	12.30	14.32
15	05	21.36	26.70	16.55	21.89	19.81	22.80	15.00	17.99
	15	22.16	29.32	17.35	24.51	19.89	22.94	15.08	18.13
	18	22.37	31.25	17.56	26.44	19.85	24.05	15.04	19.24
	19	21.90	29.63	17.09	24.82	19.24	22.03	14.43	17.22
	35	22.00	31.24	17.19	26.43	19.41	21.99	14.60	17.18
	97	21.83	28.88	17.02	24.07	19.47	22.56	14.66	17.75
17	02	28.52	41.76	25.82	39.06	21.36	25.26	18.66	22.56
	06	25.91	35.51	23.21	32.81	21.95	25.91	19.25	23.21
	08	24.90	33.63	22.20	30.93	22.42	27.39	19.72	24.69
	26	25.48	36.27	22.78	33.57	21.84	25.87	19.14	23.17
	35	25.72	39.27	23.02	36.57	21.87	25.52	19.17	22.82
	75	31.32	42.61	28.62	39.91	22.32	28.61	19.62	25.91
	99	25.53	36.09	22.83	33.39	21.97	26.13	19.27	23.43
19	11	32.11	45.70	26.07	39.66	28.70	37.12	22.66	31.08
	32	31.32	44.72	25.28	38.68	26.84	31.92	20.80	25.88
	35	31.63	48.08	25.59	42.04	27.01	31.58	20.97	25.54
21	11	38.04	57.88	32.78	52.62	30.78	40.28	25.52	35.02
	16	35.14	50.42	29.88	45.16	30.18	37.94	24.92	32.68
	35	35.42	56.08	30.16	50.82	29.89	36.33	24.63	31.07
	39	36.80	57.13	31.54	51.87	31.00	40.77	25.74	35.51
	41	35.34	52.71	30.08	47.45	29.60	36.31	24.34	31.05
	48	43.18	62.45	37.92	57.19	29.14	35.53	23.88	30.27
	75	46.76	63.43	41.50	58.17	28.76	35.43	23.50	30.17
23	21	43.03	66.28	37.97	61.22	36.52	49.90	31.46	44.84
	35	41.39	67.54	36.33	62.48	34.39	42.54	29.33	37.48
	53	41.45	63.64	36.39	58.58	34.03	42.44	28.97	37.38
	55	42.20	65.27	37.14	60.21	34.50	43.27	29.44	38.21
25	04	50.35	80.20	45.22	75.07	41.15	54.76	36.02	49.63
	07	53.89	86.22	48.76	81.09	38.10	47.97	32.97	42.84
	08	72.93	104.76	67.80	99.63	36.93	48.76	31.80	43.63
	11	53.95	77.92	48.82	72.79	40.53	54.62	35.40	49.49
	19	51.69	83.70	46.56	78.57	39.15	53.30	34.02	48.17
	20	57.95	88.17	52.82	83.04	36.38	46.63	31.25	41.50
	24	51.19	82.55	46.06	77.42	39.55	53.99	34.42	48.86
	29	49.51	78.48	44.38	73.35	40.52	55.86	35.39	50.73
	35	47.30	80.13	42.17	75.00	38.34	48.13	33.21	43.00
	37	50.33	79.94	45.20	74.81	38.86	51.08	33.73	45.95
	43	49.55	80.23	44.42	75.10	40.13	55.43	35.00	50.30
	44	67.77	98.66	62.64	93.53	36.69	48.98	31.56	43.85
	46	53.63	77.47	48.50	72.34	37.21	47.37	32.08	42.24
61	46.60	73.35	41.47	68.22	38.06	48.95	32.93	43.82	

Souriau 8D series - composite

Backshells

M85049 composite backshells

Dimensions and ordering

Straight backshell for EMI/RFI heat shrink boots (type 88)

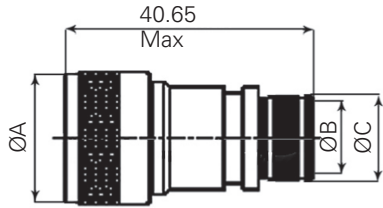

Straight cable clamp (type 91)

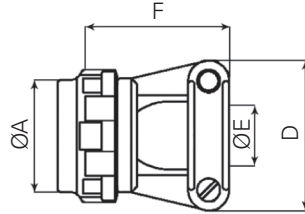

90° cable clamp (type 92)

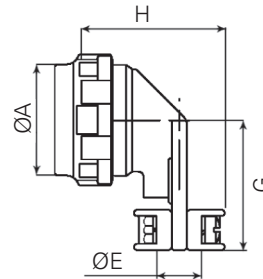

Shell size	ØA Max	ØB ^{+0.10} Entry size		ØC Entry size		D Max	E Max	F Max	G	H
		02	03	02	03					
09	21.80	N/A	6.35	N/A	10.03	24.90	5.55	21.25	22.20	26.95
11	25.00	N/A	7.92	N/A	11.61	26.00	6.70	24.30	23.80	27.95
13	29.40	7.92	11.13	11.61	14.81	30.50	8.75	27.95	26.20	30.00
15	32.50	11.13	14.27	14.81	17.96	33.00	11.70	27.95	28.60	33.00
17	35.70	12.70	15.88	16.38	19.56	36.10	13.85	31.25	33.30	35.05
19	38.50	15.88	19.05	19.56	22.73	38.60	15.60	35.80	34.95	36.85
21	41.70	15.88	20.62	19.56	24.30	41.65	17.75	38.35	38.10	39.15
23	44.90	17.47	23.83	21.06	27.51	45.00	19.80	42.15	41.30	41.15
25	48.00	19.05	25.40	22.73	29.08	48.00	21.60	44.70	44.45	42.95

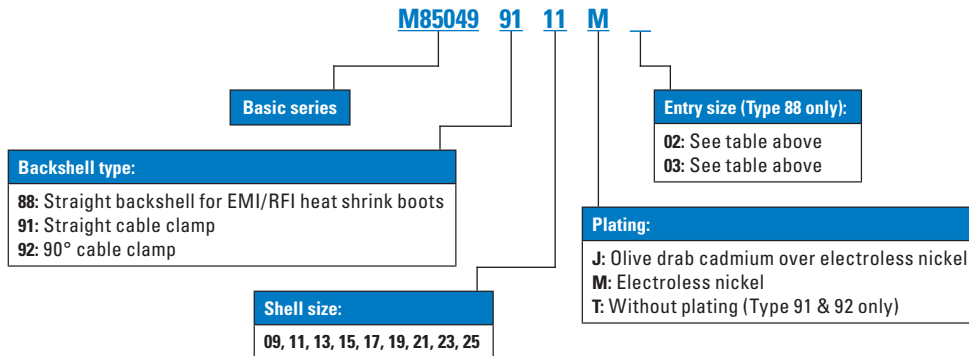

Note: All dimensions are in millimeters (mm).

Connector part numbers

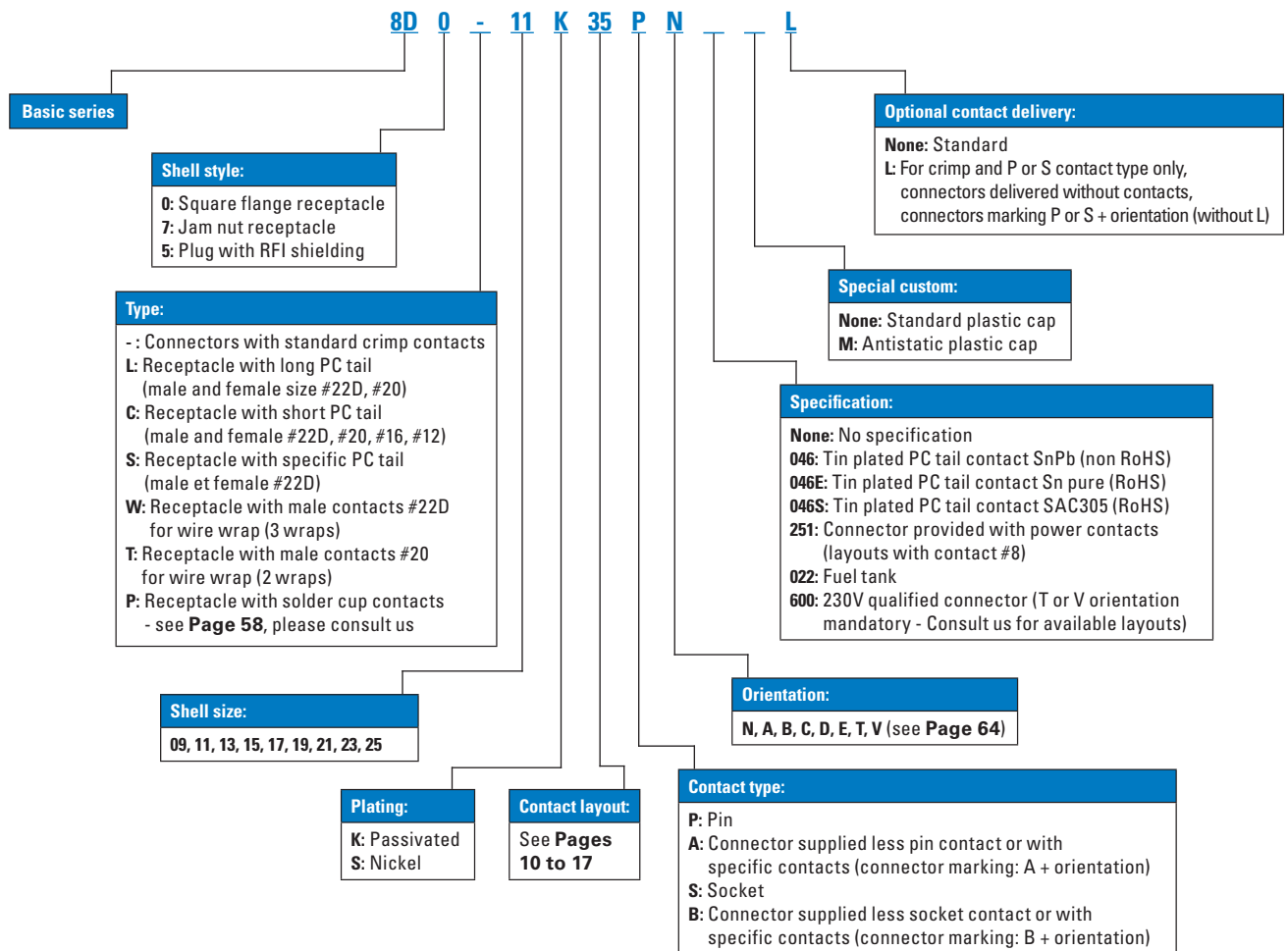

Note: PC tail contacts without shoulder also available. Please see **Page 23**. 8DV plug with reinforced locking available. Please see **Page 13**.

BACC part numbers

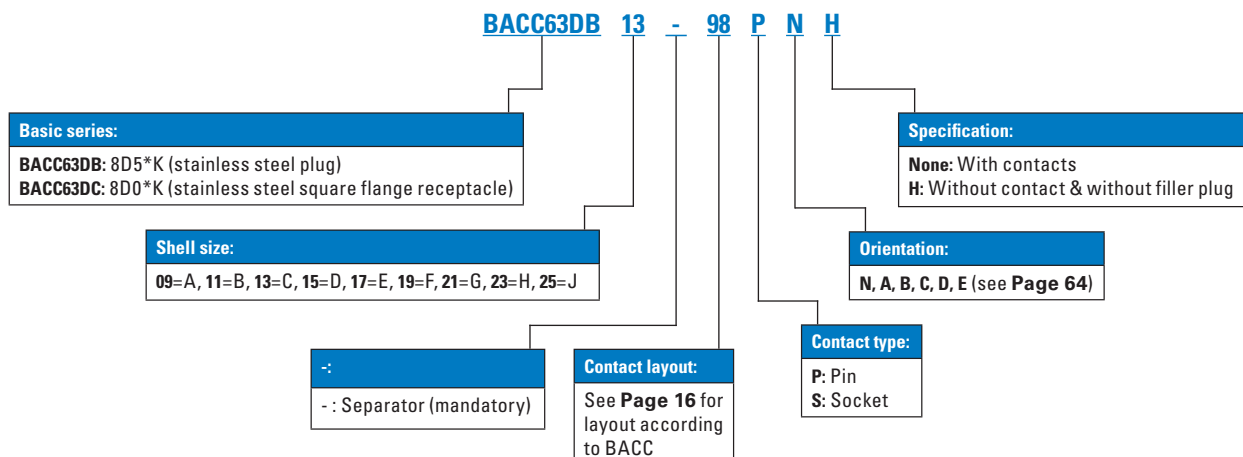

Souriau 8D series - stainless steel

Part numbers

MIL-DTL-38999 part numbers

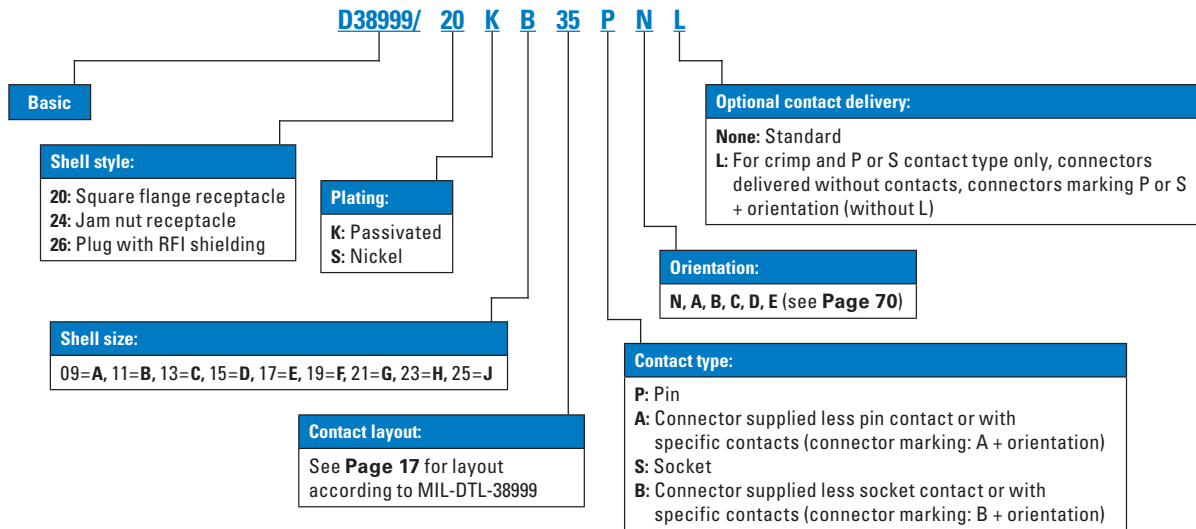

Note: To place an order of MIL connectors delivered without MIL removable crimp contacts and keep P or S plus orientation marking, it must be clearly specified on the order by adding a suffix L at the end of the P/N or specified in comment.

Delivered with MIL contacts mandatory.

As stated in MIL-DTL-38999, class K connectors with #8 cavities may not meet the firewall requirement.

EN3645 part numbers

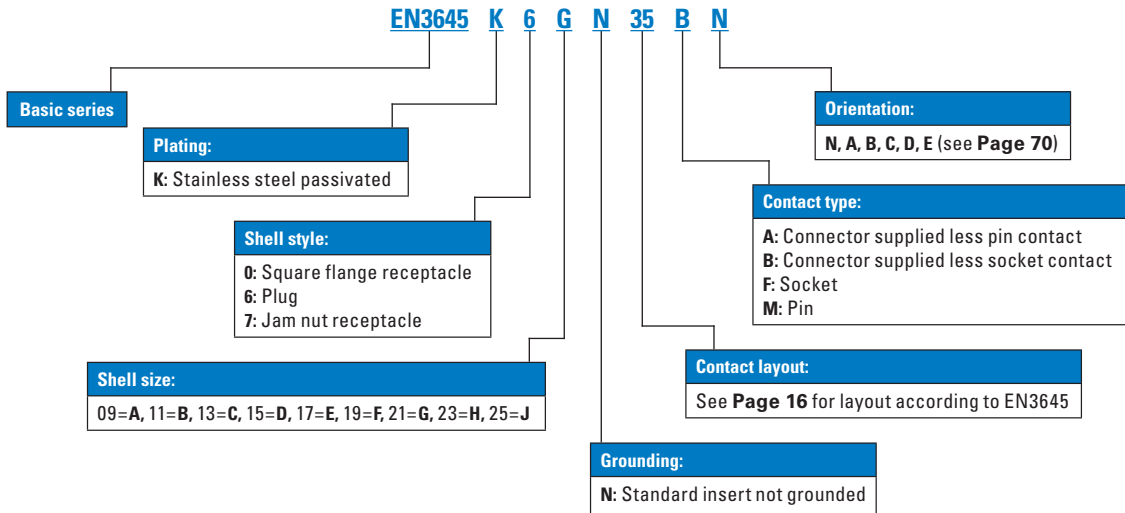

Dimensions

Receptacle type 0 (8D) or type 20 (D38999)

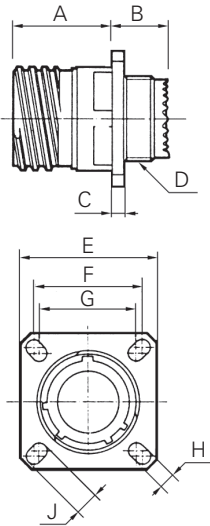

Shell size	A Max	B Max	C Max	D Thread	E ^{±0.3}	F	G	H ^{±0.2}	J ^{±0.2}
09 (A)	20.2	11.4	2.5	M12 x 1-6g	23.8	18.26	15.09	3.25	5.49
11 (B)	20.2	11.4	2.5	M15 x 1-6g	26.2	20.62	18.26	3.25	4.93
13 (C)	20.2	11.4	2.5	M18 x 1-6g	28.6	23.01	20.62	3.25	4.93
15 (D)	20.2	11.4	2.5	M22 x 1-6g	31	24.61	23.01	3.25	4.39
17 (E)	20.2	11.4	2.5	M25 x 1-6g	33.3	26.97	24.61	3.25	4.93
19 (F)	20.2	11.4	2.5	M28 x 1-6g	36.5	29.36	26.97	3.25	4.93
21 (G)	19.8	11.8	3.2	M31 x 1-6g	39.7	31.75	29.36	3.25	4.93
23 (H)	19.8	11.8	3.2	M34 x 1-6g	42.9	34.93	31.75	3.91	6.15
25 (J)	19.8	11.8	3.2	M37 x 1-6g	46	38.1	34.93	3.91	6.15

Receptacle type 7 (8D) or type 24 (D38999)

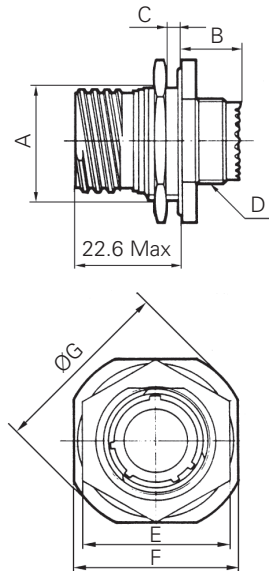

Shell size	A ^{±0.15}	B Max	C Max	D Thread	E Max	F ^{±0.4}	ØG Max
09 (A)	16.53	9.9	3.2	M12 x 1-6g	23	27	30.5
11 (B)	19.07	9.9	3.2	M15 x 1-6g	26	31.8	35.2
13 (C)	23.82	9.9	3.2	M18 x 1-6g	31	34.9	38.4
15 (D)	26.97	9.9	3.2	M22 x 1-6g	34	38.1	41.6
17 (E)	30.15	9.9	3.2	M25 x 1-6g	37	41.3	44.8
19 (F)	33.32	9.9	3.2	M28 x 1-6g	41	46	49.5
21 (G)	36.50	9.9	3.2	M31 x 1-6g	46	49.2	52.7
23 (H)	39.67	9.9	3.2	M34 x 1-6g	47	52.4	55.9
25 (J)	42.85	9.9	3.2	M37 x 1-6g	51.23	55.6	59

Recommended coupling torque on panel for jam nut receptacle (type 7)

Shell	09 (A)	11 (B)	13 (C)	15 (D)	17 (E)	19 (F)	21 (G)	23 (H)	25 (J)
Coupling torque (±0.5 N.m)	4	5	7	8	9	10	12	13	14

Note: All dimensions are in millimeters (mm).

Souriau 8D series - stainless steel

Dimensions

Dimensions

Plug type 5 (8D) or type 26 (D38999)

8D type 5 & D38999 type 26

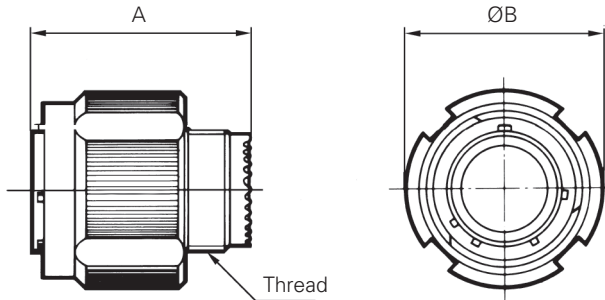

8DV plug with reinforced locking available. Please see [Page 14](#).

Shell size	A Max	Thread	ØB Max
09 (A)	31.00	M12 x 1-6g	21.80
11 (B)	31.00	M15 x 1-6g	25.00
13 (C)	31.00	M18 x 1-6g	29.40
15 (D)	31.00	M22 x 1-6g	32.50
17 (E)	31.00	M25 x 1-6g	35.70
19 (F)	31.00	M28 x 1-6g	38.50
21 (G)	31.00	M31 x 1-6g	41.70
23 (H)	31.00	M34 x 1-6g	44.90
25 (J)	31.00	M37 x 1-6g	48.00

Mated connectors dimensions

Type 0 with plug

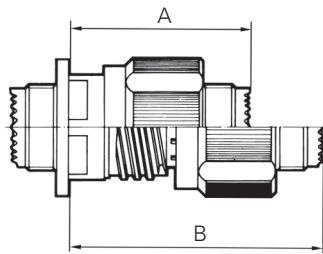

Type 7 with plug

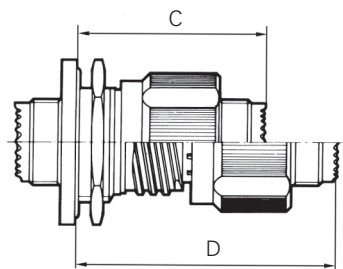

Shell size	A Max	B Max	C Max	D Max
09 (A)	37.00	52.30	38.30	53.60
11 (B)	37.00	52.30	38.30	53.60
13 (C)	37.00	52.30	38.50	53.80
15 (D)	37.00	52.30	38.50	53.80
17 (E)	37.00	52.30	38.50	53.80
19 (F)	37.00	52.30	38.50	53.80
21 (G)	36.00	51.30	38.50	53.80
23 (H)	36.00	51.30	38.50	53.80
25 (J)	36.00	51.30	38.50	53.80

Note: All dimensions are in millimeters (mm).

PC tail contacts lengths

ØA	Contact size	Contact type	PC tail type	Shell size										
				09 (A)	11 (B)	13 (C)	15 (C)	17 (E)	19 (F)	21 (G)	23 (H)	25 (J)		
ØA	#22D	M & F	Max	L & C	0.70	0.70	0.70	0.70	0.70	0.70	0.70	0.70	0.70	
		M & F	Max	S	0.50	0.50	0.50	0.50	0.50	0.50	0.50	0.50	0.50	
	#20	M & F	Max	C	0.70	0.70	0.70	0.70	0.70	0.70	0.70	0.70		
	#16	M & F	Max	C	1.15	1.15	1.15	1.15	1.15	1.15	1.15	1.15		
	#12	M & F	Max	C	2.05	2.05	2.05	2.05	2.05	2.05	2.05	2.05		
	L1	#22D	M	Min	L & C	10.52	10.52	10.34	10.34	10.34	10.34	10.34	10.34	10.34
			M	Max	L & C	11.46	11.46	11.28	11.28	11.28	11.28	11.28	11.28	11.28
			F	Min	L & C	10.19	10.19	10.01	10.01	10.01	10.01	10.01	10.01	10.01
F			Max	L & C	11.46	11.46	11.28	11.28	11.28	11.28	11.28	11.28	11.28	
#20		M	Min	S	10.19	10.19	10.01	10.01	10.01	10.01	10.01	10.01	10.01	
		M	Max	S	11.46	11.46	11.28	11.28	11.28	11.28	11.28	11.28	11.28	
		F	Min	S	10.69	10.69	10.51	10.51	10.51	10.51	10.51	10.51	10.51	
		F	Max	S	11.63	11.63	11.45	11.45	11.45	11.45	11.45	11.45	11.45	
		#16	M	Min	C	10.36	10.36	10.18	10.18	10.18	10.18	10.18	10.18	10.18
			M	Max	C	11.63	11.63	11.45	11.45	11.45	11.45	11.45	11.45	11.45
			F	Min	C	10.69	10.69	10.51	10.51	10.51	10.51	10.51	10.51	10.51
			F	Max	C	11.63	11.63	11.45	11.45	11.45	11.45	11.45	11.45	11.45
#12		M	Min	C	10.69	10.69	10.51	10.51	10.51	10.51	10.51	10.51	10.51	
		M	Max	C	11.63	11.63	11.45	11.45	11.45	11.45	11.45	11.45	11.45	
		F	Min	C	10.69	10.69	10.51	10.51	10.51	10.51	10.51	10.51	10.51	
		F	Max	C	11.63	11.63	11.45	11.45	11.45	11.45	11.45	11.45	11.45	
L2	#22D	M & F	Max	L	8.50	8.50	8.50	8.50	8.50	8.50	8.50	8.50	8.50	
		M & F	Max	C	4.00	4.00	4.00	4.00	4.00	4.00	4.00	4.00	4.00	
		M & F	Max	S	5.10	5.10	5.10	5.10	5.10	5.10	5.10	5.10	5.10	
	#20	M & F	Max	C	5.10	5.10	5.10	5.10	5.10	5.10	5.10	5.10	5.10	
	#16	M & F	Max	C	5.10	5.10	5.10	5.10	5.10	5.10	5.10	5.10	5.10	
	#12	M & F	Max	C	5.10	5.10	5.10	5.10	5.10	5.10	5.10	5.10	5.10	
	L3	#22D	M	Min	L & C	9.48	9.48	9.48	9.48	9.48	9.48	9.59	9.59	9.59
			M	Max	L & C	10.58	10.58	10.58	10.58	10.58	10.58	10.69	10.69	10.69
			F	Min	L & C	9.15	9.15	9.15	9.15	9.15	9.15	9.26	9.26	9.26
			F	Max	L & C	10.58	10.58	10.58	10.58	10.58	10.58	10.69	10.69	10.69
			M	Min	S	9.65	9.65	9.65	9.65	9.65	9.65	9.76	9.76	9.76
			M	Max	S	10.75	10.75	10.75	10.75	10.75	10.75	10.86	10.86	10.86
F			Min	S	9.15	9.15	9.15	9.15	9.15	9.15	9.26	9.26	9.26	
F			Max	S	10.75	10.75	10.75	10.75	10.75	10.75	10.86	10.86	10.86	
#20		M	Min	C	9.65	9.65	9.65	9.65	9.65	9.65	9.76	9.76	9.76	
		M	Max	C	10.75	10.75	10.75	10.75	10.75	10.75	10.86	10.86	10.86	
		F	Min	C	9.65	9.65	9.65	9.65	9.65	9.65	9.76	9.76	9.76	
		F	Max	C	10.75	10.75	10.75	10.75	10.75	10.75	10.86	10.86	10.86	
#16		M	Min	C	9.64	9.64	9.64	9.64	9.64	9.64	9.75	9.75	9.75	
		M	Max	C	10.75	10.75	10.75	10.75	10.75	10.75	10.86	10.86	10.86	
		F	Min	C	9.64	9.64	9.64	9.64	9.64	9.64	9.75	9.75	9.75	
		F	Max	C	10.75	10.75	10.75	10.75	10.75	10.75	10.86	10.86	10.86	
#12		M	Min	C	10.25	10.25	10.25	10.25	10.25	10.25	9.95	9.95	9.95	
		M	Max	C	11.21	11.21	11.21	11.21	11.21	11.21	10.91	10.91	10.91	
		F	Min	C	10.25	10.25	10.25	10.25	10.25	10.25	9.95	9.95	9.95	
		F	Max	C	11.21	11.21	11.21	11.21	11.21	11.21	10.91	10.91	10.91	

M: Male contact
F: Female contact

L: Long PC tail
C: Short PC tail
S: Specific PC tail

Receptacle type 7

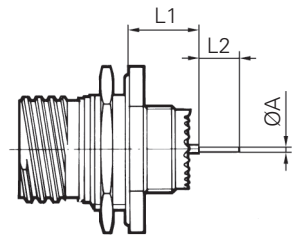

Receptacle type 0

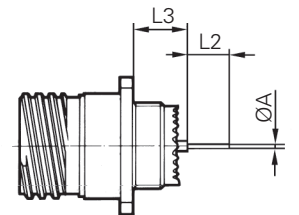

Note: All dimensions are in millimeters (mm).

Souriau 8D series - stainless steel

Connector weight

Connector weight - in grams (±15%)

Shell size & Layout		With contacts								Without contacts							
		Plug 8D (type 5)		Plug 8DV (type 5)		Recep. (type 0)		Recep. (type 7)		Plug 8D (type 5)		Plug 8DV (type 5)		Recep. (type 0)		Recep. (type 7)	
		Male	Female	Male	Female	Male	Female	Male	Female	Male	Female	Male	Female	Male	Female	Male	Female
09	35	30.63	32.21	32.53	34.11	23.93	25.51	33.93	35.51	30.21	30.71	32.11	32.61	23.51	24.01	33.51	34.01
	98	30.63	31.93	32.53	33.83	23.93	25.23	33.93	35.23	30.21	30.73	32.11	32.63	23.51	24.03	33.51	34.03
11	01	38.13	41.07	41.53	44.47	29.53	32.47	42.43	45.37	37.47	39.47	40.87	42.87	28.87	30.87	41.77	43.77
	02	37.86	40.32	41.16	43.70	29.26	31.72	42.16	44.62	37.24	38.76	40.54	42.14	28.64	30.16	41.54	43.06
	04	37.95	41.01	41.35	44.41	29.35	32.41	42.25	45.31	37.39	39.41	40.79	42.81	28.79	30.81	41.69	43.71
	05	37.98	41.19	41.38	44.59	29.38	32.59	42.28	45.49	37.28	39.19	40.68	42.59	28.68	30.59	41.58	43.49
	22	37.60	39.96	40.88	42.94	29.00	31.36	41.90	44.26	37.32	38.96	40.74	42.44	28.72	30.36	41.62	43.26
	35	37.88	41.35	41.28	44.75	29.28	32.75	42.18	45.65	36.97	38.10	40.37	41.50	28.37	29.50	41.27	42.40
	80	41.11	44.49	41.52	48.24	32.51	35.89	45.41	48.79	36.61	37.49	38.26	41.24	28.01	28.89	40.91	41.79
	98	37.85	40.61	41.25	44.01	29.25	32.01	42.15	44.91	37.01	38.21	40.41	41.61	28.41	29.61	41.31	42.51
	99	37.98	41.06	41.42	44.64	29.38	32.46	42.28	45.36	37.00	38.26	40.44	41.84	28.40	29.66	41.30	42.56
13	04	53.34	57.12	56.64	60.42	37.94	41.72	56.24	60.02	52.10	54.00	55.40	57.30	36.70	38.60	55.00	56.90
	08	53.72	58.90	57.02	62.20	38.32	43.50	56.62	61.80	52.60	55.70	55.90	59.00	37.20	40.30	55.50	58.60
	26	54.09	59.74	57.39	63.04	38.69	44.34	56.99	62.64	52.35	55.04	55.65	58.34	36.95	39.64	55.25	57.94
	35	53.52	59.29	56.82	62.59	38.12	43.89	56.42	62.19	51.98	53.79	55.28	57.09	36.58	38.39	54.88	56.69
	98	53.38	58.00	56.68	61.30	37.98	42.60	56.28	60.90	51.98	54.00	55.28	57.30	36.58	38.60	54.88	56.90
15	05	64.49	69.83	68.49	73.83	45.69	51.03	67.59	72.93	62.94	65.93	66.94	69.93	44.14	47.13	66.04	69.03
	15	65.29	72.45	69.29	76.45	46.49	53.65	68.39	75.55	63.02	66.07	67.02	70.07	44.22	47.27	66.12	69.17
	18	65.50	74.38	69.50	78.38	46.70	55.58	68.60	77.48	62.98	67.18	66.98	71.18	44.18	48.38	66.08	70.28
	19	65.03	72.76	69.03	76.76	46.23	53.96	68.13	75.86	62.37	65.16	66.37	69.16	43.57	46.36	65.47	68.26
	35	65.13	74.37	69.13	78.37	46.33	55.57	68.23	77.47	62.54	65.12	66.54	69.12	43.74	46.32	65.64	68.22
	97	64.96	72.01	68.96	76.01	46.16	53.21	68.06	75.11	62.60	65.69	66.60	69.69	43.80	46.89	65.70	68.79
	99	64.96	72.01	68.96	76.01	46.16	53.21	68.06	75.11	62.60	65.69	66.60	69.69	43.80	46.89	65.70	68.79
17	02	71.68	84.92	82.70	97.54	66.78	80.02	89.88	103.12	64.52	68.42	79.43	90.99	59.62	63.52	82.72	86.62
	06	69.07	78.67	73.97	83.57	64.17	73.77	87.27	96.87	65.11	69.07	70.01	73.97	60.21	64.17	83.31	87.27
	08	68.06	76.79	72.96	81.69	63.16	71.89	86.26	94.99	65.58	70.55	70.48	75.45	60.68	65.65	83.78	88.75
	26	68.64	79.43	73.54	84.33	63.74	74.53	86.84	97.63	65.00	69.03	69.90	73.93	60.10	64.13	83.20	87.23
	35	68.88	82.43	73.78	87.33	63.98	77.53	87.08	100.63	65.03	68.68	69.93	73.58	60.13	63.78	83.23	86.88
	75	74.48	85.77	79.38	90.67	69.58	80.87	92.68	103.97	65.48	71.77	70.38	76.67	60.58	66.87	83.68	89.97
19	11	87.04	100.63	87.99	101.58	67.69	81.28	97.59	111.18	83.63	92.05	84.58	93.00	64.28	72.70	94.18	102.60
	32	86.25	99.65	87.20	100.60	66.90	80.30	96.80	110.20	81.77	86.85	82.72	87.80	62.42	67.50	92.32	97.40
	35	86.56	103.01	87.51	103.96	67.21	83.66	97.11	113.56	81.94	86.51	82.89	87.46	62.59	67.16	92.49	97.06
	99	86.56	103.01	87.51	103.96	67.21	83.66	97.11	113.56	81.94	86.51	82.89	87.46	62.59	67.16	92.49	97.06
	99	86.56	103.01	87.51	103.96	67.21	83.66	97.11	113.56	81.94	86.51	82.89	87.46	62.59	67.16	92.49	97.06
21	11	99.71	119.55	101.71	121.55	81.81	101.65	111.81	131.65	92.45	101.95	94.45	103.95	74.55	84.05	104.55	114.05
	16	96.81	112.09	98.81	114.09	78.91	94.19	108.91	124.19	91.85	99.61	93.85	101.61	73.95	81.71	103.95	111.71
	38	97.09	117.75	99.09	119.75	79.19	99.85	109.19	129.85	91.56	98.00	93.56	100.00	73.66	80.10	103.66	110.10
	39	98.47	118.80	100.47	120.80	80.57	100.90	110.57	130.90	92.67	102.44	94.67	104.44	74.77	84.54	104.77	114.54
	41	97.01	114.38	99.01	116.38	79.11	96.48	109.11	126.48	91.27	97.98	93.27	99.98	73.37	80.08	103.37	110.08
	48	104.85	124.12	105.84	125.82	86.95	106.22	116.95	136.22	90.81	97.20	92.72	99.62	72.91	79.30	102.91	109.30
	75	108.43	125.10	110.72	127.62	90.53	107.20	120.53	137.20	90.43	97.10	92.72	99.62	72.53	79.20	102.53	109.20
	99	108.43	125.10	110.72	127.62	90.53	107.20	120.53	137.20	90.43	97.10	92.72	99.62	72.53	79.20	102.53	109.20
23	06	125.05	147.53	118.01	141.26	106.85	129.33	139.05	161.53	98.05	105.53	111.50	124.88	79.85	87.33	112.05	119.53
	35	107.17	133.32	116.37	142.52	88.97	115.12	121.17	147.32	100.17	108.32	109.37	117.52	81.97	90.12	114.17	122.32
	53	107.23	129.42	116.43	138.62	89.03	111.22	121.23	143.42	99.81	108.22	109.01	117.42	81.61	90.02	113.81	122.22
	55	107.98	131.05	117.18	140.25	89.78	112.85	121.98	145.05	100.28	109.05	109.48	118.25	82.08	90.85	114.28	123.05
25	04	120.80	150.65	141.50	165.90	103.00	132.85	135.40	165.25	111.60	125.21	116.71	127.65	93.80	107.41	126.20	139.81
	07	124.34	156.67	140.51	160.51	106.54	138.87	138.94	171.27	108.55	118.42	119.71	132.71	90.75	100.62	123.15	133.02
	08	143.38	175.21	130.34	162.35	125.58	157.41	157.98	189.81	107.38	119.21	117.80	131.95	89.58	101.41	121.98	133.81
	11	124.40	148.37	129.84	161.20	106.60	130.57	139.00	162.97	110.98	125.07	118.20	132.64	93.18	107.27	125.58	139.67
	19	122.14	154.15	128.16	157.13	104.34	136.35	136.74	168.75	109.60	123.75	119.17	134.51	91.80	105.95	124.20	138.35
	20	128.40	158.62	125.95	158.78	110.60	140.82	143.00	173.22	106.83	117.08	116.99	126.78	89.03	99.28	121.43	131.68
	24	121.64	153.00	128.18	156.46	103.84	135.20	136.24	167.60	110.00	124.44	116.71	127.60	92.20	106.64	124.60	139.04
	29	119.96	148.93	148.55	173.18	102.16	131.13	134.56	163.53	110.97	126.31	115.01	125.28	93.17	108.51	125.57	140.91
	35	117.75	150.58	128.20	158.88	99.95	132.78	132.35	165.18	108.79	118.58	118.78	134.08	90.99	100.78	123.39	133.18
	37	120.78	150.39	130.50	154.34	102.98	132.59	135.38	164.99	109.31	121.53	115.86	126.02	91.51	103.73	123.91	136.13
	43	120.00	150.68	125.25	152.00	102.20	132.88	134.60	165.28	110.58	125.88	116.71	127.60	92.78	108.08	125.18	140.48
	44	138.22	169.11	151.58	183.41	120.42	151.31	152.82	183.71	107.14	119.43	115.58	127.41	89.34	101.63	121.74	134.03
	46	124.08	147.92	136.60	166.82	106.28	130.12	138.68	162.52	107.66	117.82	115.03	125.28	89.86	100.02	122.26	132.42
61	117.05	143.80	129.00	158.85	99.25	126.00	131.65	158.40	108.51	119.40	119.80	133.41	90.71	101.60	123.11	13	

Connector part numbers

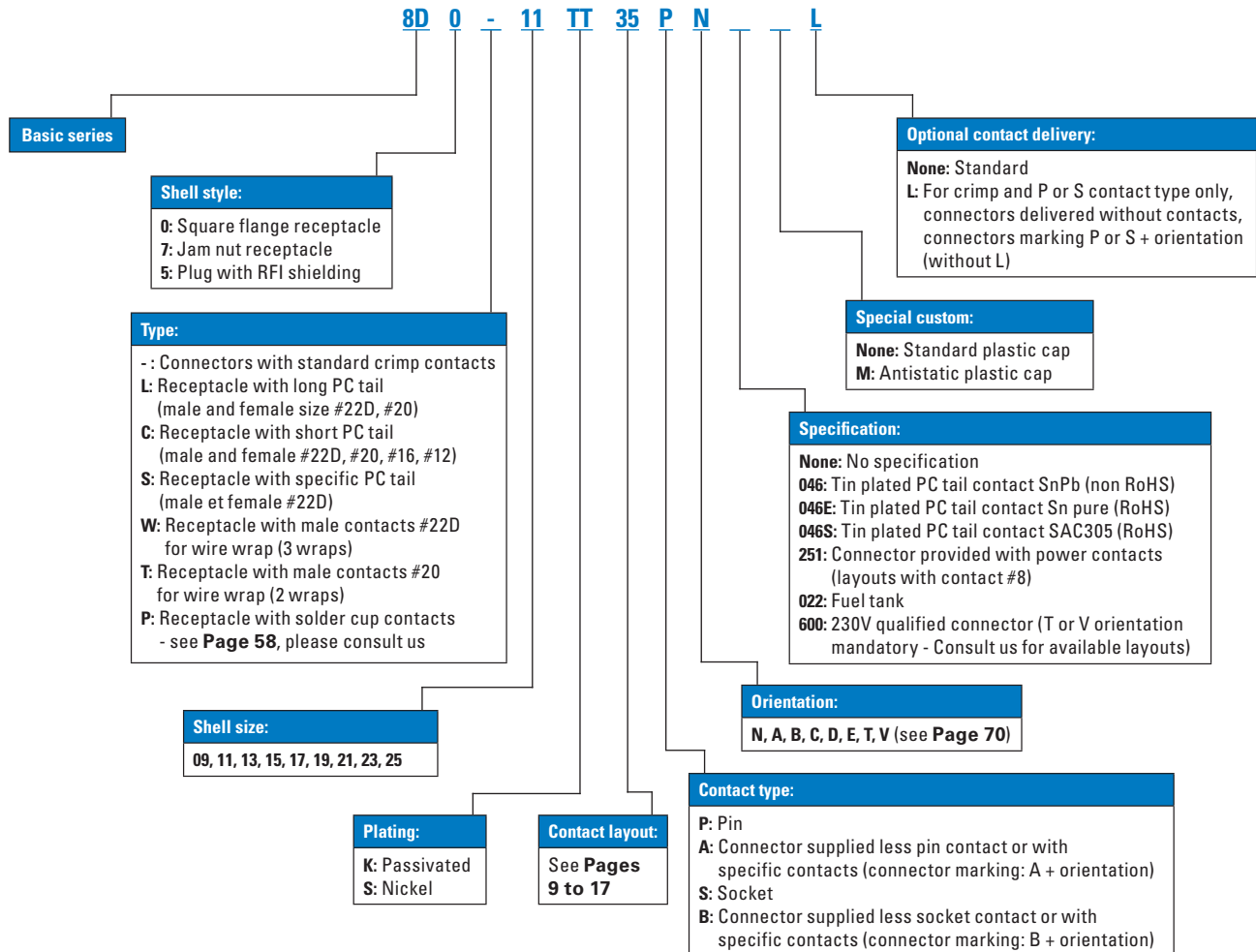

Note: PC tail contacts without shoulder also available. Please see **Page 23**.

Souriau 8D series - titanium

Dimensions

Dimensions

Receptacle type 0

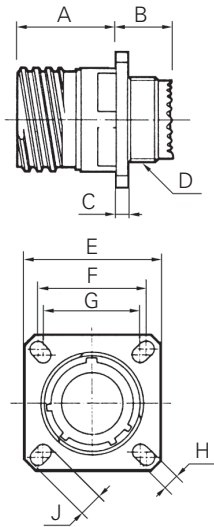

Shell size	A Max	B Max	C Max	D Thread	E ^{±0.3}	F	G	H ^{±0.2}	J ^{±0.2}
09 (A)	20.2	11.4	2.5	M12 x 1-6g	23.8	18.26	15.09	3.25	5.49
11 (B)	20.2	11.4	2.5	M15 x 1-6g	26.2	20.62	18.26	3.25	4.93
13 (C)	20.2	11.4	2.5	M18 x 1-6g	28.6	23.01	20.62	3.25	4.93
15 (D)	20.2	11.4	2.5	M22 x 1-6g	31	24.61	23.01	3.25	4.39
17 (E)	20.2	11.4	2.5	M25 x 1-6g	33.3	26.97	24.61	3.25	4.93
19 (F)	20.2	11.4	2.5	M28 x 1-6g	36.5	29.36	26.97	3.25	4.93
21 (G)	19.8	11.8	3.2	M31 x 1-6g	39.7	31.75	29.36	3.25	4.93
23 (H)	19.8	11.4	3.2	M34 x 1-6g	42.9	34.93	31.75	3.91	6.15
25 (J)	19.8	11.4	3.2	M37 x 1-6g	46	38.1	34.93	3.91	6.15

Receptacle type 7

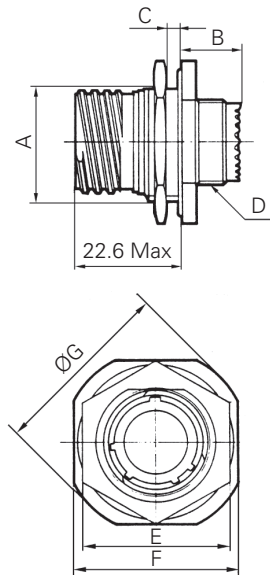

Shell size	A ^{±0.15}	B Max	C Max	D Thread	E Max	F ^{±0.4}	ØG Max
09 (A)	16.53	9.9	3.2	M12 x 1-6g	23	27	30.5
11 (B)	19.07	9.9	3.2	M15 x 1-6g	26	31.8	35.2
13 (C)	23.82	9.9	3.2	M18 x 1-6g	31	34.9	38.4
15 (D)	26.97	9.9	3.2	M22 x 1-6g	34	38.1	41.6
17 (E)	30.15	9.9	3.2	M25 x 1-6g	37	41.3	44.8
19 (F)	33.32	9.9	3.2	M28 x 1-6g	41	46	49.5
21 (G)	36.50	9.9	3.2	M31 x 1-6g	46	49.2	52.7
23 (H)	39.67	9.9	3.2	M34 x 1-6g	47	52.4	55.9
25 (J)	42.85	9.9	3.2	M37 x 1-6g	51.23	55.6	59

Recommended coupling torque on panel for jam nut receptacle (type 7)

Shell	09 (A)	11 (B)	13 (C)	15 (D)	17 (E)	19 (F)	21 (G)	23 (H)	25 (J)
Coupling torque (±0.5 N.m)	4	5	7	8	9	10	12	13	14

Note: All dimensions are in millimeters (mm).

Dimensions

Plug type 5

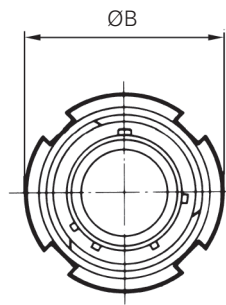
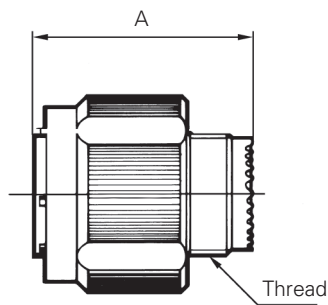

Shell size	A Max	Thread	ØB Max
09 (A)	31.00	M12 x 1-6g	21.80
11 (B)	31.00	M15 x 1-6g	25.00
13 (C)	31.00	M18 x 1-6g	29.40
15 (D)	31.00	M22 x 1-6g	32.50
17 (E)	31.00	M25 x 1-6g	35.70
19 (F)	31.00	M28 x 1-6g	38.50
21 (G)	31.00	M31 x 1-6g	41.70
23 (H)	31.00	M34 x 1-6g	44.90
25 (J)	31.00	M37 x 1-6g	48.00

Mated connectors dimensions

Type 0 with plug

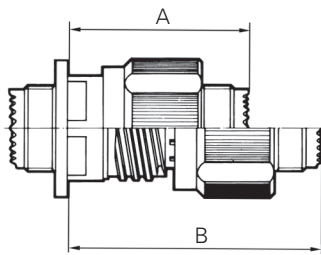

Type 7 with plug

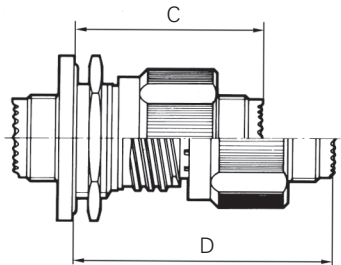

Shell size	A Max	B Max	C Max	D Max
09 (A)	37.00	52.30	38.30	53.60
11 (B)	37.00	52.30	38.30	53.60
13 (C)	37.00	52.30	38.50	53.80
15 (D)	37.00	52.30	38.50	53.80
17 (E)	37.00	52.30	38.50	53.80
19 (F)	37.00	52.30	38.50	53.80
21 (G)	36.00	51.30	38.50	53.80
23 (H)	36.00	51.30	38.50	53.80
25 (J)	36.00	51.30	38.50	53.80

Note: All dimensions are in millimeters (mm).

Souriau 8D series - titanium

PC tail contacts lengths

PC tail contacts lengths

ØA	Contact size	Contact type	PC tail type	Shell size										
				09 (A)	11 (B)	13 (C)	15 (C)	17 (E)	19 (F)	21 (G)	23 (H)	25 (J)		
ØA	#22D	M & F	Max	L & C	0.70	0.70	0.70	0.70	0.70	0.70	0.70	0.70	0.70	
		M & F	Max	S	0.50	0.50	0.50	0.50	0.50	0.50	0.50	0.50	0.50	
	#20	M & F	Max	C	0.70	0.70	0.70	0.70	0.70	0.70	0.70	0.70	0.70	
	#16	M & F	Max	C	1.15	1.15	1.15	1.15	1.15	1.15	1.15	1.15	1.15	
	#12	M & F	Max	C	2.05	2.05	2.05	2.05	2.05	2.05	2.05	2.05	2.05	
	L1	#22D	M	Min	L & C	10.52	10.52	10.34	10.34	10.34	10.34	10.34	10.34	10.34
			M	Max	L & C	11.46	11.46	11.28	11.28	11.28	11.28	11.28	11.28	11.28
		F	Min	L & C	10.19	10.19	10.01	10.01	10.01	10.01	10.01	10.01	10.01	
		F	Max	L & C	11.46	11.46	11.28	11.28	11.28	11.28	11.28	11.28	11.28	
		M	Min	S	10.19	10.19	10.01	10.01	10.01	10.01	10.01	10.01	10.01	
		M	Max	S	11.46	11.46	11.28	11.28	11.28	11.28	11.28	11.28	11.28	
		F	Min	S	10.69	10.69	10.51	10.51	10.51	10.51	10.51	10.51	10.51	
F		Max	S	11.63	11.63	11.45	11.45	11.45	11.45	11.45	11.45	11.45		
#20		M	Min	C	10.36	10.36	10.18	10.18	10.18	10.18	10.18	10.18	10.18	
		M	Max	C	11.63	11.63	11.45	11.45	11.45	11.45	11.45	11.45	11.45	
		F	Min	C	10.69	10.69	10.51	10.51	10.51	10.51	10.51	10.51	10.51	
		F	Max	C	11.63	11.63	11.45	11.45	11.45	11.45	11.45	11.45	11.45	
#16	M	Min	C	10.69	10.69	10.51	10.51	10.51	10.51	10.51	10.51	10.51		
	M	Max	C	11.63	11.63	11.45	11.45	11.45	11.45	11.45	11.45	11.45		
	F	Min	C	10.69	10.69	10.51	10.51	10.51	10.51	10.51	10.51	10.51		
	F	Max	C	11.63	11.63	11.45	11.45	11.45	11.45	11.45	11.45	11.45		
#12	M	Min	C	10.63	10.63	10.45	10.45	10.45	10.45	10.45	10.45	10.45		
	M	Max	C	11.56	11.56	11.38	11.38	11.38	11.38	11.38	11.38	11.38		
	F	Min	C	10.63	10.63	10.45	10.45	10.45	10.45	10.45	10.45	10.45		
	F	Max	C	11.56	11.56	11.38	11.38	11.38	11.38	11.38	11.38	11.38		
L2	#22D	M & F	Max	L	8.50	8.50	8.50	8.50	8.50	8.50	8.50	8.50	8.50	
		M & F	Max	C	4.00	4.00	4.00	4.00	4.00	4.00	4.00	4.00	4.00	
		M & F	Max	S	5.10	5.10	5.10	5.10	5.10	5.10	5.10	5.10	5.10	
	#20	M & F	Max	C	5.10	5.10	5.10	5.10	5.10	5.10	5.10	5.10	5.10	
	#16	M & F	Max	C	5.10	5.10	5.10	5.10	5.10	5.10	5.10	5.10	5.10	
	#12	M & F	Max	C	5.10	5.10	5.10	5.10	5.10	5.10	5.10	5.10	5.10	
	L3	#22D	M	Min	L & C	9.48	9.48	9.48	9.48	9.48	9.48	9.59	9.59	9.59
			M	Max	L & C	10.58	10.58	10.58	10.58	10.58	10.58	10.69	10.69	10.69
		F	Min	L & C	9.15	9.15	9.15	9.15	9.15	9.15	9.26	9.26	9.26	
		F	Max	L & C	10.58	10.58	10.58	10.58	10.58	10.58	10.69	10.69	10.69	
		M	Min	S	9.65	9.65	9.65	9.65	9.65	9.65	9.76	9.76	9.76	
		M	Max	S	10.75	10.75	10.75	10.75	10.75	10.75	10.86	10.86	10.86	
F		Min	S	9.15	9.15	9.15	9.15	9.15	9.15	9.26	9.26	9.26		
F		Max	S	10.75	10.75	10.75	10.75	10.75	10.75	10.86	10.86	10.86		
#20		M	Min	C	9.65	9.65	9.65	9.65	9.65	9.65	9.76	9.76	9.76	
		M	Max	C	10.75	10.75	10.75	10.75	10.75	10.75	10.86	10.86	10.86	
		F	Min	C	9.65	9.65	9.65	9.65	9.65	9.65	9.76	9.76	9.76	
		F	Max	C	10.75	10.75	10.75	10.75	10.75	10.75	10.86	10.86	10.86	
#16	M	Min	C	9.64	9.64	9.64	9.64	9.64	9.64	9.75	9.75	9.75		
	M	Max	C	10.75	10.75	10.75	10.75	10.75	10.75	10.86	10.86	10.86		
	F	Min	C	9.64	9.64	9.64	9.64	9.64	9.64	9.75	9.75	9.75		
	F	Max	C	10.75	10.75	10.75	10.75	10.75	10.75	10.86	10.86	10.86		
#12	M	Min	C	10.25	10.25	10.25	10.25	10.25	10.25	9.95	9.95	9.95		
	M	Max	C	11.21	11.21	11.21	11.21	11.21	11.21	10.91	10.91	10.91		
	F	Min	C	10.25	10.25	10.25	10.25	10.25	10.25	9.95	9.95	9.95		
	F	Max	C	11.21	11.21	11.21	11.21	11.21	11.21	10.91	10.91	10.91		

M: Male contact
F: Female contact

L: Long PC tail
C: Short PC tail
S: Specific PC tail

Receptacle type 7

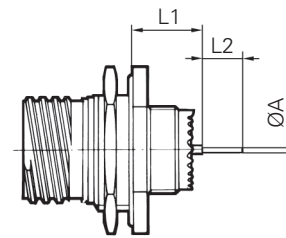

Receptacle type 0

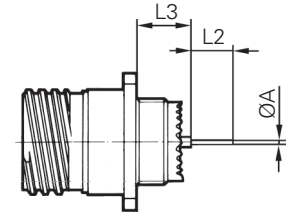

Note: All dimensions are in millimeters (mm).

Connector weight - in grams ($\pm 15\%$)

Shell size & Layout		With contacts						Without contacts					
		Plug (type 5)		Receptacle (type 0)		Receptacle (type 7)		Plug (type 5)		Receptacle (type 0)		Receptacle (type 7)	
		Male	Female	Male	Female	Male	Female	Male	Female	Male	Female	Male	Female
09	35	18.23	19.81	14.37	15.95	20.14	21.72	17.81	18.31	13.95	14.45	19.72	20.22
	98	18.23	19.53	14.37	15.67	20.14	21.44	17.81	18.33	13.95	14.47	19.72	20.24
11	01	23.15	26.09	18.19	21.13	25.63	28.57	22.49	24.49	17.53	19.53	24.97	26.97
	02	22.78	25.32	17.82	20.36	28.1	30.64	22.16	23.76	17.2	18.8	27.48	29.08
	04	22.97	26.03	18.01	21.07	25.45	28.51	22.41	24.43	17.45	19.47	24.89	26.91
	05	23.00	26.21	18.04	21.25	25.24	28.69	22.30	24.21	17.34	19.25	24.78	26.69
	22	22.64	25.06	17.68	20.10	27.96	30.38	22.36	24.06	17.40	19.10	27.68	29.38
	35	22.90	26.37	17.94	21.41	25.14	28.85	21.99	23.12	17.03	18.16	24.47	25.60
	80	25.38	29.86	20.08	24.88	30.66	35.78	22.10	22.86	16.80	17.88	27.38	28.78
	98	22.87	25.63	17.91	20.67	25.35	28.11	22.03	23.23	17.07	18.27	24.51	25.71
	99	23.04	26.26	18.06	21.28	25.53	28.75	22.06	23.46	17.08	18.48	24.55	25.95
13	04	32.44	36.22	23.56	27.34	34.11	37.89	31.20	33.10	22.32	24.22	32.87	34.77
	08	32.82	38.00	23.94	29.12	34.49	39.67	31.70	34.80	22.82	25.92	33.37	36.47
	26	33.19	38.84	24.31	29.96	34.86	40.51	31.45	34.14	22.57	25.26	33.12	35.81
	35	32.62	38.39	23.74	29.51	34.29	40.06	31.08	32.89	22.20	24.01	32.75	34.56
	98	32.48	37.10	23.60	28.22	34.15	38.77	31.08	33.10	22.20	24.22	32.75	34.77
15	05	39.61	44.95	28.77	34.11	41.40	46.74	38.06	41.05	27.22	30.21	39.85	42.84
	15	40.41	47.57	29.57	36.73	42.20	49.36	38.14	41.19	27.30	30.35	39.93	42.98
	18	40.62	49.50	29.78	38.66	42.41	51.29	38.10	42.30	27.26	31.46	39.89	44.09
	19	40.15	47.88	29.31	37.04	41.94	49.67	37.49	40.28	26.65	29.44	39.28	42.07
	35	40.25	49.49	29.41	38.65	42.04	51.28	37.66	40.24	26.82	29.40	39.45	42.03
	97	40.08	47.13	29.24	36.29	41.87	48.92	37.72	40.81	26.88	29.97	39.51	42.60
17	02	48.16	58.40	45.20	55.44	63.99	74.23	44.89	51.85	41.93	48.89	60.72	67.68
	06	43.73	53.33	40.90	50.50	54.23	63.83	39.77	43.73	36.94	40.90	50.27	54.23
	08	42.72	51.45	39.89	48.62	53.22	61.95	40.24	45.21	37.41	42.38	50.74	55.71
	26	43.30	54.09	40.47	51.26	53.80	64.59	39.66	43.69	36.83	40.86	50.16	54.19
	35	43.54	57.09	40.71	54.26	54.04	67.59	39.69	43.34	36.86	40.51	50.19	53.84
	75	49.14	60.43	46.31	57.60	59.64	70.93	40.14	46.43	37.31	43.60	50.64	56.93
	99	43.35	53.91	40.52	51.08	53.85	64.41	39.79	43.95	36.96	41.12	50.29	54.45
19	11	55.16	68.75	44.00	57.59	61.25	74.84	51.75	60.17	40.59	66.26	40.59	66.26
	32	54.37	67.77	43.21	56.61	60.46	73.86	49.89	54.97	38.73	61.06	38.73	61.06
	35	54.68	71.13	43.52	59.97	60.77	77.22	50.06	54.63	38.90	60.72	38.90	60.72
21	11	64.64	84.48	54.31	74.15	71.62	91.46	57.38	66.88	47.05	73.86	47.05	73.86
	16	61.74	77.02	51.41	66.69	68.72	84.00	56.78	64.54	46.45	71.52	46.45	71.52
	35	62.02	82.68	51.69	72.35	69.00	89.66	56.49	62.93	46.16	69.91	46.16	69.91
	39	63.40	83.73	53.07	73.40	70.38	90.71	57.60	67.37	47.27	74.35	47.27	74.35
	41	61.94	79.31	51.61	66.29	68.92	86.29	56.20	62.91	45.87	69.89	45.87	69.89
	48	68.73	88.71	58.4	78.38	81.56	101.54	55.61	62.51	45.28	52.18	68.44	75.34
	75	73.61	90.51	63.28	80.18	86.44	103.34	55.61	62.51	45.28	52.18	68.44	75.34
23	21	71.07	94.32	60.57	83.82	79.15	102.40	64.56	77.94	54.06	86.02	54.06	86.02
	35	69.43	95.58	58.93	85.08	77.51	103.66	62.43	70.58	51.93	78.66	51.93	78.66
	53	69.49	91.68	58.99	81.18	77.57	99.76	62.07	70.48	51.57	78.56	51.57	78.56
	55	70.24	93.31	59.74	82.81	78.32	101.39	62.54	71.31	52.04	79.39	52.04	79.39
25	07	83.91	117.09	73.64	123.58	99.34	121.8	68.12	78.84	57.85	85.33	83.55	83.55
	11	91.92	111.92	81.65	101.65	94.65	127.35	71.12	84.12	60.85	73.85	86.55	99.55
	19	81.78	113.79	71.51	103.52	90.20	122.21	69.24	83.39	58.97	91.81	58.97	91.81
	24	81.28	112.64	71.01	102.37	89.70	121.06	69.64	84.08	59.37	92.50	59.37	92.50
	29	79.60	108.57	69.33	98.30	88.02	116.99	70.61	85.95	60.34	94.37	60.34	94.37
	35	77.39	110.22	67.12	99.95	85.81	118.64	68.43	78.22	58.16	86.64	58.16	86.64
	37	79.59	107.09	69.32	116.12	95.02	113.36	68.12	79.04	57.85	87.26	83.55	84.50
	44	99.96	127.50	89.69	134.23	115.39	134.44	66.42	77.85	56.15	86.33	81.85	84.54
	43	79.64	110.32	69.37	100.05	88.06	118.74	70.22	85.52	59.95	93.94	59.95	93.94
	46	81.94	105.78	71.67	95.51	90.36	114.20	67.30	77.46	57.03	85.88	57.03	85.88
	61	76.69	103.44	66.42	93.17	85.11	111.86	68.15	79.04	57.88	87.46	57.88	87.46
	08	103.02	134.85	92.75	124.58	111.44	143.27	67.02	78.85	56.75	87.27	56.75	87.27
	20	88.04	118.26	77.77	107.99	96.46	126.68	66.47	76.72	56.20	85.14	56.20	85.14
04	80.44	110.29	70.17	100.02	88.86	118.71	71.24	84.85	60.97	93.27	60.97	93.27	

Souriau 8D series - bronze

Part numbers

Connector part numbers

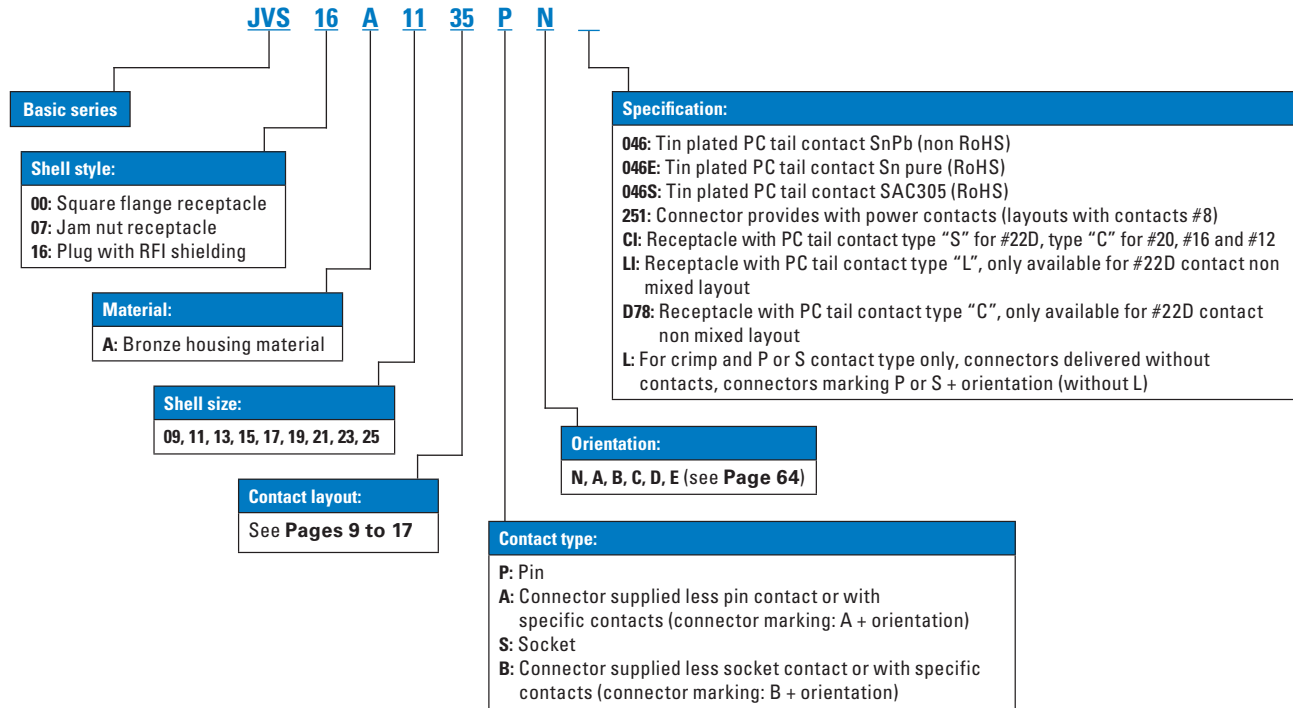

CECC part numbers

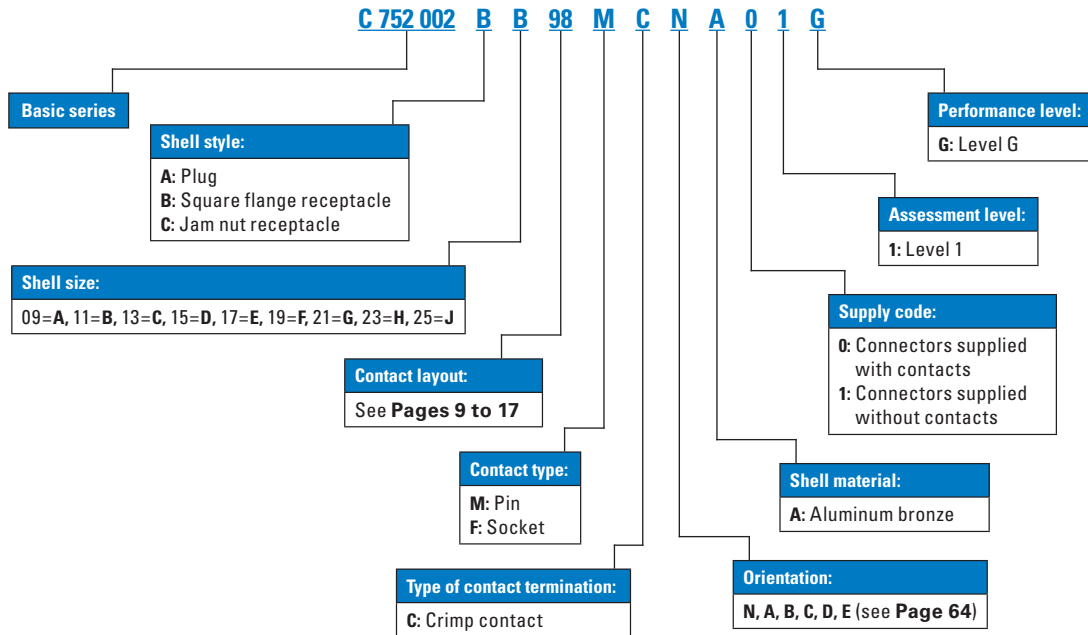

Note: C 752 002 refers to the abbreviated form of the CECC 75 201-002 type designation.

Dimensions

Receptacle type 00 (JVS) or type B (CECC)

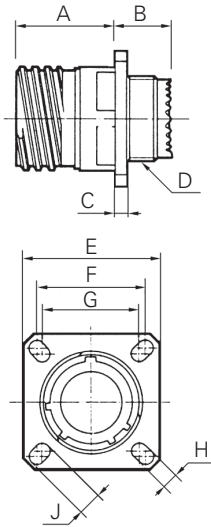

Shell size	A Max	B Max	C Max	D Thread	E ^{+0.3}	F	G	H ^{+0.2}	J ^{+0.2}
09 (A)	20.2	11.4	2.5	M12 x 1-6g	23.8	18.26	15.09	3.25	5.49
11 (B)	20.2	11.4	2.5	M15 x 1-6g	26.2	20.62	18.26	3.25	4.93
13 (C)	20.2	11.4	2.5	M18 x 1-6g	28.6	23.01	20.62	3.25	4.93
15 (D)	20.2	11.4	2.5	M22 x 1-6g	31	24.61	23.01	3.25	4.39
17 (E)	20.2	11.4	2.5	M25 x 1-6g	33.3	26.97	24.61	3.25	4.93
19 (F)	20.2	11.4	2.5	M28 x 1-6g	36.5	29.36	26.97	3.25	4.93
21 (G)	19.8	11.8	3.2	M31 x 1-6g	39.7	31.75	29.36	3.25	4.93
23 (H)	19.8	11.4	3.2	M34 x 1-6g	42.9	34.93	31.75	3.91	6.15
25 (J)	19.8	11.4	3.2	M37 x 1-6g	46	38.1	34.93	3.91	6.15

Receptacle type 07 (JVS) or type C (CECC)

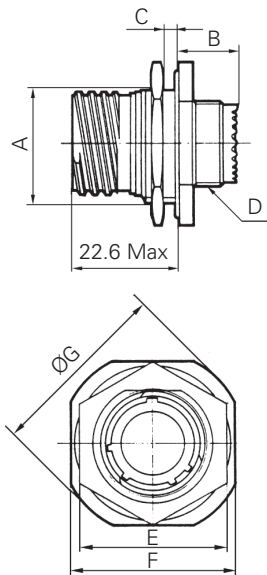

Shell size	A ^{+0.15}	B Max	C Max	D Thread	E Max	F ^{+0.4}	ØG Max
09 (A)	16.53	9.9	3.2	M12 x 1-6g	24	27	30.5
11 (B)	19.07	9.9	3.2	M15 x 1-6g	27	31.8	35.2
13 (C)	23.82	9.9	3.2	M18 x 1-6g	32	34.9	38.4
15 (D)	26.97	9.9	3.2	M22 x 1-6g	36	38.1	41.6
17 (E)	30.15	9.9	3.2	M25 x 1-6g	37	41.3	44.8
19 (F)	33.32	9.9	3.2	M28 x 1-6g	41	46	49.5
21 (G)	36.50	9.9	3.2	M31 x 1-6g	46	49.2	52.7
23 (H)	39.67	9.9	3.2	M34 x 1-6g	50	52.4	55.9
25 (J)	42.85	9.9	3.2	M37 x 1-6g	50	55.6	59

Recommended coupling torque on panel for jam nut receptacle (type 7)

Shell	09 (A)	11 (B)	13 (C)	15 (D)	17 (E)	19 (F)	21 (G)	23 (H)	25 (J)
Coupling torque (±0.5 N.m)	4	5	7	8	9	10	12	13	14

Note: All dimensions are in millimeters (mm).

Souriau 8D series - bronze

Dimensions

Dimensions

Plug type 16 (JVS) or type A (CECC)

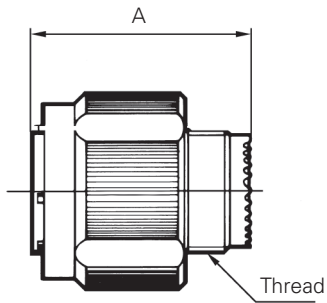

Shell size	A Max	Thread	ØB Max
09 (A)	31.00	M12 x 1-6g	21.10
11 (B)	31.00	M15 x 1-6g	23.80
13 (C)	31.00	M18 x 1-6g	28.20
15 (D)	31.00	M22 x 1-6g	31.40
17 (E)	31.00	M25 x 1-6g	36.50
19 (F)	31.00	M28 x 1-6g	39.30
21 (G)	31.00	M31 x 1-6g	42.50
23 (H)	31.00	M34 x 1-6g	45.30
25 (J)	31.00	M37 x 1-6g	48.40

Mated connectors dimensions

Type 0 with plug

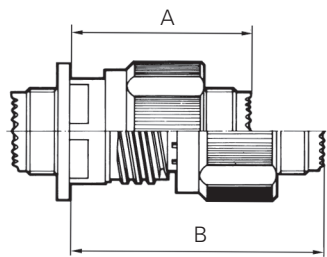

Type 7 with plug

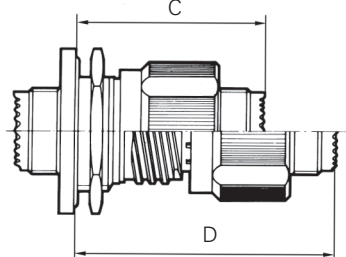

Shell size	A Max	B Max	C Max	D Max
09 (A)	37.00	52.30	38.30	53.60
11 (B)	37.00	52.30	38.30	53.60
13 (C)	37.00	52.30	38.30	53.60
15 (D)	37.00	52.30	38.30	53.60
17 (E)	37.00	52.30	38.30	53.60
19 (F)	37.00	52.30	38.30	53.60
21 (G)	36.00	51.30	38.30	53.60
23 (H)	36.00	51.30	38.30	53.60
25 (J)	36.00	51.30	38.30	53.60

Dummy receptacle

Orientation: N, A, B, C, D, E

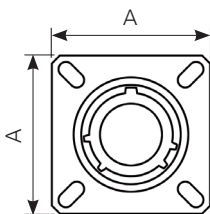

Orientation: DU (= all orientations)

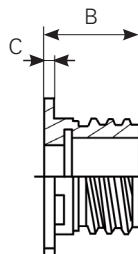
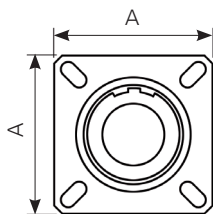

Example part numbers:

- JVS BN 02 A 17 N
- JVS BN 02 A 17 DU

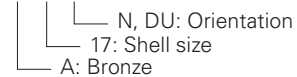

Equivalent to CECC blind hole. For information only:
 CECC75201002AxA00A (x = shell size A, B, C, D, ...)
 CECC75201002EA00A (blind hole) = JVSBN02A17DU (through hole)
 (no correspondence CECC with N, A, B, C, D, E orientations)

Shell size	9	11	13	15	17	19	21	23	25
A ^{+0.3} _{-0.3}	23.8	26.2	28.6	31	33.3	36.5	39.7	42.9	46
B maxi	24.2	24.2	24.2	24.2	24.2	24.2	24.1	24.1	24.1
C maxi	2.5	2.5	2.5	2.5	2.5	2.5	3.2	3.2	3.2

Note: All dimensions are in millimeters (mm).

PC tail contacts lengths

Contact size	Contact type	PC tail type	Shell size											
			09 (A)	11 (B)	13 (C)	15 (C)	17 (E)	19 (F)	21 (G)	23 (H)	25 (J)			
ØA	#22D	M & F Max L & C	0.70	0.70	0.70	0.70	0.70	0.70	0.70	0.70	0.70	0.70	0.70	
		M & F Max S	0.50	0.50	0.50	0.50	0.50	0.50	0.50	0.50	0.50	0.50	0.50	
	#20	M & F Max C	0.70	0.70	0.70	0.70	0.70	0.70	0.70	0.70	0.70	0.70	0.70	
	#16	M & F Max C	1.15	1.15	1.15	1.15	1.15	1.15	1.15	1.15	1.15	1.15	1.15	
	#12	M & F Max C	2.05	2.05	2.05	2.05	2.05	2.05	2.05	2.05	2.05	2.05	2.05	
	L1	#22D	M Min L & C	10.52	10.52	10.34	10.34	10.34	10.34	10.34	10.34	10.34	10.34	10.34
			M Max L & C	11.46	11.46	11.28	11.28	11.28	11.28	11.28	11.28	11.28	11.28	11.28
		F Min L & C	10.19	10.19	10.01	10.01	10.01	10.01	10.01	10.01	10.01	10.01	10.01	
		F Max L & C	11.46	11.46	11.28	11.28	11.28	11.28	11.28	11.28	11.28	11.28	11.28	
		M Min S	10.19	10.19	10.01	10.01	10.01	10.01	10.01	10.01	10.01	10.01	10.01	
		M Max S	11.46	11.46	11.28	11.28	11.28	11.28	11.28	11.28	11.28	11.28	11.28	
		F Min S	10.69	10.69	10.51	10.51	10.51	10.51	10.51	10.51	10.51	10.51	10.51	
F Max S		11.63	11.63	11.45	11.45	11.45	11.45	11.45	11.45	11.45	11.45	11.45		
#20		M Min C	10.36	10.36	10.18	10.18	10.18	10.18	10.18	10.18	10.18	10.18	10.18	
		M Max C	11.63	11.63	11.45	11.45	11.45	11.45	11.45	11.45	11.45	11.45	11.45	
		F Min C	10.69	10.69	10.51	10.51	10.51	10.51	10.51	10.51	10.51	10.51	10.51	
		F Max C	11.63	11.63	11.45	11.45	11.45	11.45	11.45	11.45	11.45	11.45	11.45	
#16		M Min C	10.69	10.69	10.51	10.51	10.51	10.51	10.51	10.51	10.51	10.51	10.51	
		M Max C	11.63	11.63	11.45	11.45	11.45	11.45	11.45	11.45	11.45	11.45	11.45	
		F Min C	10.69	10.69	10.51	10.51	10.51	10.51	10.51	10.51	10.51	10.51	10.51	
		F Max C	11.63	11.63	11.45	11.45	11.45	11.45	11.45	11.45	11.45	11.45	11.45	
#12		M Min C	10.63	10.63	10.45	10.45	10.45	10.45	10.45	10.45	10.45	10.45	10.45	
		M Max C	11.56	11.56	11.38	11.38	11.38	11.38	11.38	11.38	11.38	11.38	11.38	
		F Min C	10.63	10.63	10.45	10.45	10.45	10.45	10.45	10.45	10.45	10.45	10.45	
		F Max C	11.56	11.56	11.38	11.38	11.38	11.38	11.38	11.38	11.38	11.38	11.38	
L2		#22D	M & F Max L	8.50	8.50	8.50	8.50	8.50	8.50	8.50	8.50	8.50	8.50	8.50
			M & F Max C	4.00	4.00	4.00	4.00	4.00	4.00	4.00	4.00	4.00	4.00	4.00
			M & F Max S	5.10	5.10	5.10	5.10	5.10	5.10	5.10	5.10	5.10	5.10	5.10
		#20	M & F Max C	5.10	5.10	5.10	5.10	5.10	5.10	5.10	5.10	5.10	5.10	5.10
	#16	M & F Max C	5.10	5.10	5.10	5.10	5.10	5.10	5.10	5.10	5.10	5.10	5.10	
	#12	M & F Max C	5.10	5.10	5.10	5.10	5.10	5.10	5.10	5.10	5.10	5.10	5.10	
	L3	#22D	M Min L & C	9.48	9.48	9.48	9.48	9.48	9.48	9.48	9.48	9.59	9.59	9.59
			M Max L & C	10.58	10.58	10.58	10.58	10.58	10.58	10.58	10.58	10.69	10.69	10.69
		F Min L & C	9.15	9.15	9.15	9.15	9.15	9.15	9.15	9.15	9.26	9.26	9.26	
		F Max L & C	10.58	10.58	10.58	10.58	10.58	10.58	10.58	10.58	10.69	10.69	10.69	
		M Min S	9.65	9.65	9.65	9.65	9.65	9.65	9.65	9.65	9.76	9.76	9.76	
		M Max S	10.75	10.75	10.75	10.75	10.75	10.75	10.75	10.75	10.86	10.86	10.86	
F Min S		9.15	9.15	9.15	9.15	9.15	9.15	9.15	9.15	9.26	9.26	9.26		
F Max S		10.75	10.75	10.75	10.75	10.75	10.75	10.75	10.75	10.86	10.86	10.86		
#20		M Min C	9.65	9.65	9.65	9.65	9.65	9.65	9.65	9.65	9.76	9.76	9.76	
		M Max C	10.75	10.75	10.75	10.75	10.75	10.75	10.75	10.75	10.86	10.86	10.86	
		F Min C	9.65	9.65	9.65	9.65	9.65	9.65	9.65	9.65	9.76	9.76	9.76	
		F Max C	10.75	10.75	10.75	10.75	10.75	10.75	10.75	10.75	10.86	10.86	10.86	
#16		M Min C	9.64	9.64	9.64	9.64	9.64	9.64	9.64	9.64	9.75	9.75	9.75	
		M Max C	10.75	10.75	10.75	10.75	10.75	10.75	10.75	10.75	10.86	10.86	10.86	
		F Min C	9.64	9.64	9.64	9.64	9.64	9.64	9.64	9.64	9.75	9.75	9.75	
		F Max C	10.75	10.75	10.75	10.75	10.75	10.75	10.75	10.75	10.86	10.86	10.86	
#12		M Min C	10.25	10.25	10.25	10.25	10.25	10.25	10.25	10.25	9.95	9.95	9.95	
		M Max C	11.21	11.21	11.21	11.21	11.21	11.21	11.21	11.21	10.91	10.91	10.91	
		F Min C	10.25	10.25	10.25	10.25	10.25	10.25	10.25	10.25	9.95	9.95	9.95	
		F Max C	11.21	11.21	11.21	11.21	11.21	11.21	11.21	11.21	10.91	10.91	10.91	

M: Male contact
F: Female contact

L: Long PC tail
C: Short PC tail
S: Specific PC tail

Receptacle type 7

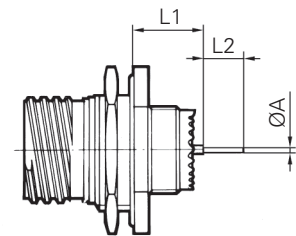

Receptacle type 0

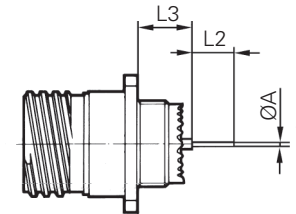

Note: All dimensions are in millimeters (mm).

Souriau 8D series - bronze

Connector weight

Connector weight - in grams ($\pm 15\%$)

Shell size & layout		With contacts						Without contacts					
		Plug (type 5)		Receptacle (type 0)		Receptacle (type 7)		Plug (type 5)		Receptacle (type 0)		Receptacle (type 7)	
		Male	Female	Male	Female	Male	Female	Male	Female	Male	Female	Male	Female
09	35	28.46	32.38	22.70	26.62	34.51	38.43	27.42	28.66	21.66	22.90	33.47	34.71
	98	28.46	31.68	22.70	25.93	34.51	37.74	27.42	28.71	21.66	22.95	33.47	34.76
11	01	37.17	44.46	29.80	37.09	45.08	52.37	35.53	40.49	28.16	33.12	43.44	48.40
	02	36.25	42.55	28.88	35.18	44.17	50.47	34.71	38.68	27.34	31.32	42.63	46.60
	04	36.72	44.31	29.35	36.94	44.63	52.23	35.33	40.34	27.96	32.97	43.24	48.26
	05	36.79	44.76	29.42	37.39	48.33	52.67	35.06	39.80	27.69	32.43	42.97	47.71
	22	35.90	41.91	28.53	34.54	43.82	49.82	35.21	39.43	27.84	32.06	43.13	47.34
	35	36.55	45.15	29.18	37.79	43.86	53.07	34.29	37.09	26.92	29.72	42.20	45.01
	80	45.40	54.33	37.96	46.89	53.35	70.43	34.23	36.45	26.79	29.08	42.77	44.37
	98	36.47	43.32	29.10	35.95	44.39	51.23	34.39	37.36	27.02	30.00	42.30	45.28
	99	36.90	44.89	29.53	37.52	44.81	52.80	34.46	37.94	27.09	30.57	42.38	45.86
13	04	52.20	61.58	38.98	48.35	59.89	69.27	49.12	53.84	35.90	40.61	56.81	61.53
	08	53.14	65.99	39.92	52.77	60.83	73.69	50.36	58.06	37.14	44.83	58.06	65.75
	26	54.06	68.08	40.84	54.85	61.75	75.77	49.74	56.42	36.52	43.19	57.44	64.11
	35	52.65	66.96	39.42	53.74	60.34	74.65	48.83	53.32	35.60	40.09	56.52	61.01
	98	52.30	63.76	39.08	50.54	59.99	71.45	48.83	53.84	35.60	40.61	56.52	61.53
15	05	64.61	77.85	48.48	61.73	73.49	86.74	60.76	68.18	44.63	52.05	69.64	77.06
	15	66.59	84.35	50.46	68.23	75.47	93.24	60.96	68.53	44.83	52.40	69.84	77.41
	18	67.11	89.14	50.98	73.02	75.99	98.02	60.86	71.28	44.73	55.15	69.74	80.16
	19	65.94	85.12	49.82	69.00	74.83	94.01	59.35	66.27	43.22	50.14	68.23	75.15
	35	66.19	89.12	50.07	72.99	75.08	98.00	59.77	66.17	43.64	50.04	68.65	75.05
	97	65.77	83.26	49.64	67.14	74.65	92.14	59.92	67.58	43.79	51.46	68.80	76.46
17	02	71.16	103.09	66.95	86.21	93.75	113.01	64.00	73.93	59.79	69.71	86.59	96.51
	06	74.18	98.00	69.99	93.81	96.76	120.58	64.36	74.18	60.16	69.99	86.93	96.76
	08	71.68	93.34	67.48	89.14	94.25	115.91	65.52	77.85	61.33	73.66	88.10	100.43
	26	73.12	99.89	68.92	95.69	95.69	122.46	64.08	74.08	59.89	69.89	86.66	96.66
	35	73.71	107.33	69.52	103.14	96.29	129.91	64.16	73.21	59.97	69.02	86.74	95.79
	75	87.60	115.61	83.41	111.42	110.18	138.19	65.28	80.88	61.08	76.69	87.85	103.46
	99	73.24	99.44	69.05	95.25	95.82	122.02	64.41	74.73	60.21	70.53	86.98	97.30
19	11	93.71	127.42	77.08	110.8	110.70	144.42	85.25	106.14	68.62	115.19	76.56	123.13
	32	91.75	124.99	75.12	108.37	108.74	141.99	80.63	93.24	64.01	102.29	71.95	110.23
	35	92.52	133.33	75.89	116.71	109.51	109.39	81.05	92.39	64.43	101.45	72.37	109.39
21	11	112.91	162.13	97.53	146.75	131.96	181.19	94.90	118.47	79.52	128.84	88.20	137.52
	16	105.72	143.63	90.33	128.24	124.77	162.68	93.41	112.66	78.03	123.03	86.71	131.72
	35	106.41	157.67	91.03	142.29	125.46	176.72	92.69	108.67	77.31	119.04	85.99	127.72
	39	109.83	160.27	94.45	144.89	128.89	179.33	95.44	119.68	80.06	130.05	88.75	138.74
	41	106.21	149.31	90.83	159.68	125.27	168.36	91.97	108.62	76.59	118.99	85.27	127.67
	48	103.63	133.84	88.25	118.46	122.61	152.90	90.52	107.64	75.14	92.26	109.58	126.70
23	75	135.19	177.13	119.80	161.74	154.25	196.18	90.52	107.64	75.14	92.26	109.58	126.70
	21	125.27	182.95	109.64	167.32	146.95	204.63	109.11	142.31	93.48	154.32	103.16	163.99
	35	121.20	186.08	105.57	170.44	142.88	207.76	103.83	124.05	88.20	136.06	97.88	145.73
	53	121.35	176.40	105.72	160.77	143.03	198.08	102.94	123.8	87.31	135.81	96.98	145.49
25	55	123.21	180.44	107.58	164.81	144.89	202.13	104.10	125.86	88.47	137.87	98.15	147.55
	07	153.58	179.40	138.29	186.55	176.55	202.05	114.40	141.15	99.11	148.3	137.37	163.70
	11	142.64	181.90	127.35	166.61	165.62	204.80	121.84	154.10	106.55	138.81	144.82	177.08
	19	148.26	227.68	132.98	212.40	171.24	250.66	117.15	152.26	101.87	164.81	112.29	175.23
	24	147.02	224.83	131.74	209.55	170.00	247.80	118.15	153.97	102.86	166.52	113.28	176.94
	29	142.86	214.73	127.57	199.45	165.83	237.70	120.55	158.61	105.27	171.16	115.69	181.58
	35	137.37	218.82	122.09	203.54	160.35	241.80	115.14	139.43	99.86	151.99	110.28	162.41
	37	153.57	170.01	138.29	177.20	176.55	192.56	114.40	141.15	99.11	148.30	137.37	163.70
	44	143.71	183.40	128.18	195.16	166.69	206.58	110.17	135.50	94.64	147.50	133.15	158.68
	43	142.96	219.07	127.67	203.79	165.93	242.05	119.58	157.54	104.30	170.10	114.72	180.52
	46	148.66	207.81	133.38	192.53	171.64	230.78	112.34	137.55	97.06	150.10	107.48	160.52
	61	135.64	202.00	120.35	186.72	158.61	224.98	114.45	141.47	99.17	154.02	109.59	164.44
	08	200.96	279.93	185.68	264.65	223.94	302.91	111.65	141.00	96.36	153.55	106.78	163.97
	20	163.80	238.77	148.51	223.49	186.77	261.75	110.28	135.71	95.00	148.26	105.42	158.68
	04	144.94	219.00	129.66	203.71	167.91	241.97	122.11	155.88	106.83	168.44	117.25	178.86











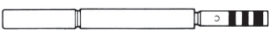







Souriau 8D series

Contacts

MIL-DTL-38999 qualified crimp contacts - 1.27µm gold plated

Contact size	Contact type	Part number	Contact Ø	Conductor section AWG		Conductor section mm ²		External Ø over insulator	
				Min	Max	Min	Max	Min	Max
#22D	Pin	M39029/58 360	0.76	26	22	0.12	0.40	0.71	1.37
	Socket	M39029/56 348	0.76	26	22	0.12	0.40	0.71	1.37
#20	Pin	M39029/58 363	1.00	24	20	0.21	0.60	1.02	2.11
	Socket	M39029/56 351	1.00	24	20	0.21	0.60	1.02	2.11
#16	Pin	M39029/58 364	1.60	20	16	0.60	1.34	1.65	2.77
	Socket	M39029/56 352	1.60	20	16	0.60	1.34	1.65	2.77
#16 Coax	Pin	M39029/76 424	1.60	RG 174 RG 179 RG 316	RG 174 RG 179 RG 316	RG 174 RG 179 RG 316	RG 174 RG 179 RG 316	1.65	2.60
	Socket	M39029/77 428	1.60	RG 174 RG 179 RG 316	RG 174 RG 179 RG 316	RG 174 RG 179 RG 316	RG 174 RG 179 RG 316	1.65	2.60
#12	Pin	M39029/58 365	2.40	14	12	1.91	3.18	2.46	3.61
	Socket	M39029/56 353	2.40	14	12	1.91	3.18	2.46	3.61
#12 Coax	Pin	M39029/102 558	2.40	RG 174 RG 179 RG 316	RG 174 RG 179 RG 316	RG 174 RG 179 RG 316	RG 174 RG 179 RG 316	2.40	2.60
	Socket	M39029/103 559	2.40	RG 174 RG 179 RG 316	RG 174 RG 179 RG 316	RG 174 RG 179 RG 316	RG 174 RG 179 RG 316	2.40	2.60
	Pin	M39029/28 211	2.40	RG 174 RG 179 RG 316	RG 174 RG 179 RG 316	RG 174 RG 179 RG 316	RG 174 RG 179 RG 316	2.40	2.60
	Socket	M39029/75 416	2.40	RG 174 RG 179 RG 316	RG 174 RG 179 RG 316	RG 174 RG 179 RG 316	RG 174 RG 179 RG 316	2.40	2.60
#10 Power	Pin	M39029/58 528	3.20	Please consult us	Please consult us	Please consult us	Please consult us	-	2.95
	Socket	M39029/56 527	3.20	Please consult us	Please consult us	Please consult us	Please consult us	-	2.95
#8 Coax	Pin	M39029/60 367	3.64	RG 180 A/U	RG 180 A/U	RG 180 A/U	RG 180 A/U	-	2.80
	Socket	M39029/59 366	3.64	RG 180 A/U	RG 180 A/U	RG 180 A/U	RG 180 A/U	-	2.80
#8 Concentric twinax (= triax)	Pin	M39029/90 529	5.50	Cable according to MIL-C17/176 00002	Cable according to MIL-C17/176 00002	Cable according to MIL-C17/176 00002	Cable according to MIL-C17/176 00002	3.15	3.40
	Socket	M39029/91 530	5.50	Cable according to MIL-C17/176 00002	Cable according to MIL-C17/176 00002	Cable according to MIL-C17/176 00002	Cable according to MIL-C17/176 00002	3.15	3.40

MIL-DTL-38999 qualified crimp contacts - 1.27µm gold plated

Contact size	Contact type	Profile	Color code
#22D	Pin		Black / Blue / Orange
	Socket		Gray / Yellow / Orange
#20	Pin		Orange / Blue / Orange
	Socket		Brown / Green / Orange
#16	Pin		Yellow / Blue / Orange
	Socket		Red / Green / Orange
#16 Coax	Pin		Yellow / Red / Yellow
	Socket		Gray / Red / Yellow
#12	Pin		Green / Blue / Orange
	Socket		Orange / Green / Orange
#12 Coax	Pin		Gray / Green / Green
	Socket		White / Green / Green
	Pin		Brown / Brown / Red
	Socket		Blue / Brown / Yellow
#10 Power	Pin		Gray / Red / Green
	Socket		Violet / Red / Green
#8 Coax	Pin		Violet / Blue / Orange
	Socket		Blue / Blue / Orange
#8 Concentric twinax (= triax)	Pin		White / Red / Green
	Socket		Black / Orange / Green

Crimp contacts compatibility

1.27µm gold plated = MIL-DTL-38999 qualified crimp contacts

0.8µm gold plated = Souriau crimp contacts

Contact plating thickness	T° cycling	Vibration			Shock	High T° exposure
		Random vib. 200°C	Sine vib. 20°C	Sine vib. 200°C		
Pin 0.8µm with Socket 1.27µm	OK	OK	-	-	-	OK
Pin 0.8µm with Socket 0.8µm	OK	OK	-	-	OK	OK
Pin 1.27µm with Socket 1.27µm	OK	OK	OK	OK	OK	OK

Souriau 8D series

Contacts

Souriau crimp contacts - 0.8µm gold plated, without color code

Contact size	Contact type	Part number	Contact Ø	Conductor section AWG		Conductor section mm ²		External Ø over insulator	
				Min	Max	Min	Max	Min	Max
#26	Pin	8599-1092A	0.50	30	26	0.055	0.13	0.60	0.71
	Socket	8599-1096A	0.50	30	26	0.055	0.13	0.60	0.71
#22D	Pin	8599-0702 900	0.76	26	22	0.12	0.40	0.71	1.37
	Socket	8599-0706 900	0.76	26	22	0.12	0.40	0.71	1.37
#20	Pin	8599-0703 SA	1.00	24	20	0.21	0.60	1.02	2.11
	Socket	8599-0707 900	1.00	24	20	0.21	0.60	1.02	2.11
#16	Pin	8599-0704 MJ	1.60	20	16	0.60	1.34	1.65	2.77
	Socket	8599-0708 900	1.60	20	16	0.60	1.34	1.65	2.77
#12	Pin	8599-0705 MJ	2.40	14	12	1.91	3.18	2.46	3.61
	Socket	8599-0709 900	2.40	14	12	1.91	3.18	2.46	3.61
#8 Power For more information, please see Page 102	Pin	8599-7544	3.64	-	8	-	8.98	4.10	4.40
	Socket	8599-7541	3.64						
	Pin	8599-7580	3.64						
	Socket	8599-7581	3.64						
	Boot	8599-4542	3.64	-	-	-	-	5.30	5.80
		8599-4547	3.64	-	-	-	-	2.50	4
	Reductor	8599-7645	3.64	10		2.73	2.77	3.13	3.33
#8 Coax	Boot	8590-4571	3.64	RG 180 A/U				-	2.80
#8 Concentric twinax (= triax)	Boot	8590-4571	5.50	Cable according to MIL-C17/176 00002				3.15	3.40
#4 Power For more information, please see Page 102	Pin	8599-7598 900	5.74	-	3	-	25	-	-
	Socket	8599-7599 900							
	Pin	8599-7534		5	4	16	21.15	-	-
	Socket	8599-7535							
	Boot	8599-4594		-	-	-	-	6.35	7.50
		8599-4593		-	-	-	-	4	5.80
	Reductor	84002352A		6		13.30		5.30	5.70
#4 Power with reduced barrel	Pin	8599-7528 900		6		13.30		5.30	5.70
	Socket	8599-7529 900							
	Boot	8599-4593		-	-	-	-	4	5.80

Souriau crimp contacts - 0.8µm gold plated, without color code

Contact size	Contact type	Information
#26	Pin	-
	Socket	-
#22D	Pin	-
	Socket	-
#20	Pin	-
	Socket	-
#16	Pin	-
	Socket	-
#12	Pin	-
	Socket	-
#8 Power For more information, please see Page 102	Pin	JVS only
	Socket	JVS only
	Pin	-
	Socket	-
	Boot	For wire #8
		For wire #10
	Reductor	For wire #10
#8 Coax	Boot	-
#8 Concentric twinax (= triax)	Boot	-
#4 Power For more information, please see Page 102	Pin	For wire 21.15 mm ² . Not included in connector part number. Must be ordered separately.
	Socket	
	Pin	For wire 21.15 mm ²
	Socket	
	Boot	For wire 16 mm ²
		For wire 10 mm ²
	Reductor	For wire 10 mm ²
#4 Power with reduced barrel	Pin	Mating part #4 / Barrel #6
	Socket	
	Boot	-

Souriau 8D series

Contacts

Straight PC tail contacts

Contact size	Contact type	PC tail type	Part number
#22D	Pin	L	8599-0720 900
	Pin	M	8599-8028 900
	Pin	C	8599-0730 900
	Pin	S	8599-0796 900
	Socket	L	8599-0721 900
	Socket	C	8599-0731 900
	Socket	S	8599-0797 900
#20	Pin	M	8599-0658 900
	Socket	M	8599-0759 900
	Pin	C	8599-0724 900
	Socket	C	8599-0725 900
	Pin	L	8599-0771 900
	Socket	L	8599-0772 900
#16	Pin	C	8599-0726 900
	Socket	C	8599-0727 900
Coax #16	Pin	C	8599-1000A 900
#12	Pin	C	8599-7929 900
	Socket	C	8599-7932 900

S: Specific PC tail
L: Long PC tail
M: Medium PC tail
C: Short PC tail

Note: PC tail contacts without shoulder also available.
Please see **Page 119**.

Coax contacts #12

Designation	Part number
Coax socket solder contact #12	THA1-0151A
Coax pin solder contact #12	THA1-0152A
Coax pin crimp contact #12	THA1-0155A
Coax socket crimp contact #12	THA1-0156A

Solder cup



Contact size	Contact type	Part number
#22D	Pin	8599-0750 900
#20	Pin	8599-0077A 900
#16	Pin	8599-7482A 900
#12	Socket	8599-7485A 900

For other contacts type please consult us.

Crimp contacts: 1500 mating

MIL-DTL-38999 contacts			
Contact size	Contact type	Part number	Color code
#22D	Pin (H)	M39029/107 620	Blue / Red / Black
	Socket (J)	M39029/106 614	Blue / Brown / Yellow
#20	Pin (H)	M39029/107 621	Blue / Red / Brown
	Socket (J)	M39029/106 615	Blue / Brown / Green
#16	Pin (H)	M39029/107 622	Blue / Red / Red
	Socket (J)	M39029/106 616	Blue / Brown / Blue
#12	Pin (H)	M39029/107 623	Blue / Red / Orange
	Socket (J)	M39029/106 617	Blue / Brown / Gray







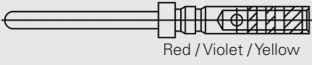

Wire wrap contacts

Contact size	Contact type	Part number	Contact Ø (mm)	Profile	
#22D	Pin	8599-0790 900	0.76		0.86
#20	Pin	8599-0791 900	1		0.86

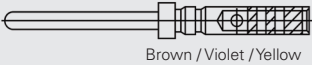
Quadrax #8 contacts

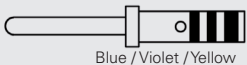
Contact type	Souriau part number	Cross norm	Impedance	Release	T° Max	
PC tail L= 4 ^{+0.1} mm	Pin	ETH1-1237A	-	100Ω	Rear	125°C
		ETH1-1501A	-	150Ω	Rear	125°C
	Socket	ETH1-1238A	-	100Ω	Rear	125°C
Crimp	Pin	ETH1-1345A	EN 3155-074	100Ω	Rear	150°C
		ETH1-1503A	-	150Ω	Rear	150°C
	Socket	ETH1-1346A	EN 3155-075	100Ω	Rear	150°C
		ETH1-1504A	-	150Ω	Rear	150°C

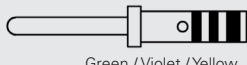
Thermocouple contacts

Contact size	Contact type	Souriau part numbers (without color code)	Part numbers	MIL-DTL-38999 contacts Profile and color code	Ø Contact (mm)	Wire section				Ø Over insulation (mm)	
						Awg	mm ²	min	max	min	max
#22D Chromel	Pin	-	M39029/87-472	 Red / Violet / Yellow	0.75	28	22	0.095	0.34	0.76	1.37
	Socket	-	M39029/88-484	 Yellow / Gray / Yellow	0.75	28	22	0.095	0.34	0.76	1.37
#22D Alumel	Pin	-	M39029/87-471	 Brown / Violet / Yellow	0.75	28	22	0.095	0.34	0.76	1.37
	Socket	-	M39029/88-483	 Orange / Gray / Yellow	0.75	28	22	0.095	0.34	0.76	1.37
#20 Chromel	Pin	8599-0749 900	8599-0949 900	 Blue / Violet / Yellow	1	24	20	0.21	0.6	1.02	2.11
	Socket	8599-0753 900	8599-0953 900	 Gray / Gray / Yellow	1	24	20	0.21	0.6	1.02	2.11
#20 Alumel	Pin	8599-0761 900	8599-0961 900	 Green / Violet / Yellow	1	24	20	0.21	0.6	1.02	2.11
	Socket	8599-0765 900	8599-0965 900	 Violet / Gray / Yellow	1	24	20	0.21	0.6	1.02	2.11

Dummy contacts

Size	Part number
#16	8599-6A016001A
#8	8599-0308
#4	8599-0310

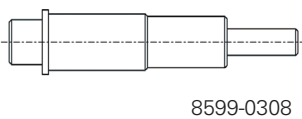

Filler plugs

Contact size	MS Part number (Rev. N)	Color	Souriau Part number	Color
#22D	MS27488-22-2	Black	8660-212	Black
#20	MS27488-20-2	Red	8522-389A	Red
#16	MS27488-16-2	Green	8522-390A	Blue
#12	MS27488-12-2	Orange	8522-391A	Yellow

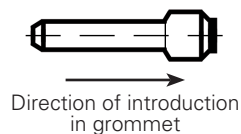

These filler plugs are installed at the rear of unwired contact to maintain connector sealing.

Souriau 8D series

Wiring instructions

Wiring instruction

Cable preparation and wire stripping

Contact size	#26	#22D	#20	#16	#12	#8	#4
L	4	4	6	6	6	12	12

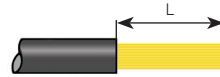

L = length of wire stripping

Insertion of wire in contact barrel

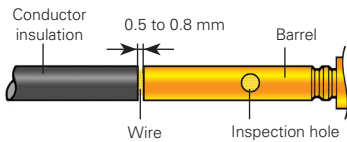

When inserting the stripped wire into the contact barrel check that no strands are left outside and that the wire is visible through the wire inspection hole in the barrel.

Important:

- Slide any accessories over wire strands before carrying out the following operations.
- Contacts are inserted and extracted from the rear of the connector.

Insertion of the contacts

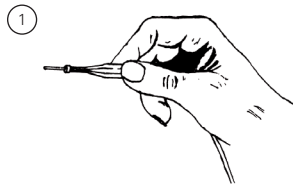

1 - Engage the crimp cable / contact assembly into the longitudinal slot of the plastic tool (colored tip). Slide the tool down the cable until the tip of the tool abuts the contact retention shoulder.

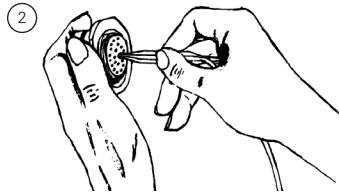

2 - Introduce the contact into the required contact cavity in the insulator, pushing tool axially, until the contact snaps into position in clip.

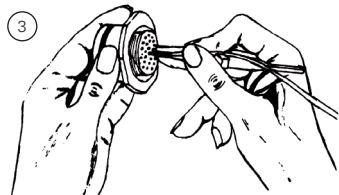

3 - Withdraw the tool from rear. Check that contact is firmly locked by pulling wire gently. When connector is fully loaded, check the position of contact tips. They should all be in the same plane. Note: For larger sizes of cable which are stiff enough manual insertion without tool is preferable.

Extraction of the contacts

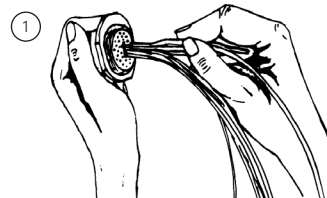

1 - Engage the appropriate cable into the longitudinal slot of the tool with the white tip towards connector.

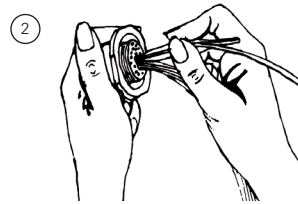

2 - Slide the tool down towards the contact. Insert the tool in the insulator until it abuts the contact shoulder.

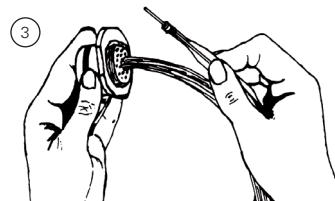

3 - Holding the tool-contact and cable assembly together, remove them simultaneously.

Tooling

Crimping tools

Contact size	Contact type	Plier M22520/1-01	Plier M22520/2-01 (Souriau 8476-01)		Plier M300BT	Pneumatic plier M22520/23-01	
		Turret part number	Norm	Souriau	Locator part number	Turret part number	Locator part number
#26	Pin	-	-	8599-0397	-	-	-
	Socket	-	-	8599-0398	-	-	-
#22D	Pin	-	M22520/2-09	-	-	-	-
	Socket	-	M22520/2-07	-	-	-	-
#20	Pin	M22520/1-04	M22520/2-10	-	-	-	-
	Socket	M22520/1-04	M22520/2-10	-	-	-	-
#16	Pin	M22520/1-04	-	-	-	-	-
	Socket	M22520/1-04	-	-	-	-	-
#12	Pin	M22520/1-04	-	-	-	-	-
	Socket	M22520/1-04	-	-	-	-	-
#8 Power	Pin	-	-	-	SP 593	M22520/23-02	8599-9601
	Socket	-	-	-	SP 593	M22520/23-02	8599-9601
#4 Power	Pin	-	-	-	-	M22520/23-04	M22520/23-11
	Socket	-	-	-	-	M22520/23-04	M22520/23-11

Contact size	Contact type	Plier M22520/2-01 (Souriau 8476-01)	Plier M22520/31-01	Plier M22520/4-01	Plier M22520/5-01
		Locator part number	Locator part number	Locator part number	Die set part number
#12 Coax M39029/102-558 M39029/103-559	Inner	-	-	-	M22520/5-03
	Outer	-	-	-	M22520/5-03
#12 Coax M39029/28-211 M39029/75-416	Inner	M22520/2-34	-	-	-
	Outer	-	M22520/31-02	-	-
#16 Coax	Inner	M22520/2-35	-	-	-
	Outer	-	-	M22520/4-02	-
#8 Coax	Inner	M22520/2-31	-	-	-
	Outer	-	-	-	M22520/5-05 closure B
#8 Concentric Twinax (= Triax)	Inner	K709	-	-	-
	Middle	-	-	-	Y631 closure B
	Ferrule	-	-	-	Y631 closure A

Note: for the #10 contact's plier and locator, please consult us.

Souriau 8D series

Tooling

Tooling

Insertion & extraction tools

Contact size	Material	Part number		Color	
		MIL standard	Souriau	Insertion	Extraction
#26	Plastic	-	8599-0394 900	Black	White
#22D	Plastic	M81969/14-01	-	Green	White
#20	Plastic	M81969/14-10	-	Red	Orange
#16	Plastic	M81969/14-03	-	Blue	White
#12	Plastic	M81969/14-04	-	Yellow	White
#10	Plastic	M81969/14-05	-	Gray	-
#8	Plastic	M81969/14-12	-	-	Green
	Metallic	-	8660-197	-	-
#4	Plastic	M81969/14-07	-	-	Blue
	Metallic	-	8533-8175	-	-

Backshell tightening tools

8498-03

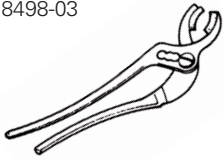

Backshell tightening pliers, part number: 8498-03
Square jaws (order 2 jaws), part number: 8500-1015

Tightening of rear accessories:

Shell size	9	11	13	15	17	19	21	23	25
Max torque in m/daN	0.62	0.62	0.62	0.62	0.62	0.62	1.24	1.24	1.24

Tightening support

8599-0831

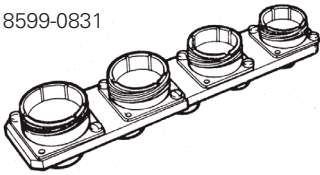

Part number: 8599-0831

This tool is made up of dummy receptacle housings of all 9 sizes for all key polarization, and secures free connectors during wiring and fitting of rear accessories.

Slackening tools

8498-04

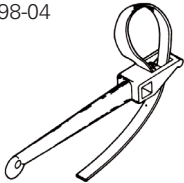

Strap clamp, part number: 8498-04
Spare strap, part number: 8498-103

Accessories

Plastic protective caps*

Shell size	Caps for receptacles	Caps for plugs	Caps for composite plugs only (J & M)	Antistatic caps for receptacles	Antistatic caps for plugs	Antistatic caps for composite plugs only (J & M)
9 (A)	MS90376-10R	8500-5587 A	MS90376-12R	MS90376-10RF	MS90376-14YF	MS90376-14YF
11 (B)	MS90376-12R	8500-5588A	8500-5598	MS90376-12RF	-	MS90376-16YF
13 (C)	MS90376-14R	8500-5600	8500-5600	MS90376-14RF	MS90376-18RF	MS90376-18RF
15 (D)	MS90376-16R	8500-5601	8500-5601	MS90376-16RF	8500-5601N	8500-5601N
17 (E)	MS90376-19R	8500-5602	8500-5602	MS90376-20YF	8500-5602N	MS90376-22RF
19 (F)	MS90376-20R	8500-5592 A	8500-5592 A	MS90376-20RF	8500-5592N	8500-5592N
21 (G)	MS90376-22R	8500-5593 A	8500-5593 A	MS90376-22RF	8500-5593N	8500-5593N
23 (H)	MS90376-24R	8500-5593 A	MS90376-28R	MS90376-24RF	8500-5593N	70472N
25 (J)	8599-0029	J599ABC6009A00	J599ABC6009A00	8500-5593N	MS90376-28RF	MS90376-28RF

* Excepted 8D composite version (X): supplied without cap

Gaskets

Shell size	Gasket for receptacles Type 0* (ordered separately)	O ring for receptacle Type 7
9 (A)	8599-5541	AS3582-019
11 (B)	8599-5542	AS3582-022
13 (C)	8599-5543	AS3582-024
15 (D)	8599-5544	AS3582-026
17 (E)	8599-5545	AS3582-028
19 (F)	8599-5546	AS3582-128
21 (G)	8599-5547	AS3582-130
23 (H)	8599-5548	AS3582-132
25 (J)	8599-5549	AS3582-134

* For front mounting

Souriau 8D series

Orientations

Orientations

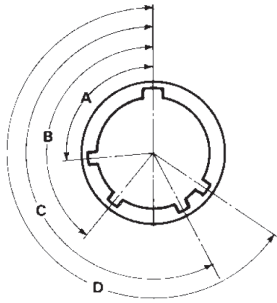

Viewed from front face of receptacle

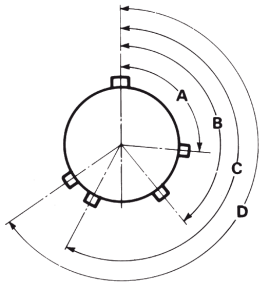

Viewed from front face of plug

Shell size	Angles	N	A	B	C	D	E	T	V
9 (A)	A°	105	102	80	35	64	91		
	B°	140	132	118	140	155	131		
	C°	215	248	230	205	234	197		
	D°	265	320	312	275	304	240		
11 (B) 15 (D)	A°	95	113	90	53	119	51		
	B°	141	156	145	156	146	141		
	C°	208	182	195	220	176	184		
	D°	236	292	252	255	298	242		
13 (C)	A°	95	113	90	53	119	51	70	75
	B°	141	156	145	156	146	141	136	138
	C°	208	182	195	220	176	184	218	224
	D°	236	292	252	255	298	242	261	268
17 (E) 21 (G)	A°	80	135	49	66	62	79	58	85
	B°	142	170	169	140	145	153	162	150
	C°	196	200	200	200	180	197	188	191
	D°	293	310	244	257	280	272	316	307
19 (F) 23 (H) 25 (J)	A°	80	135	49	66	62	79		
	B°	142	170	169	140	145	153		
	C°	196	200	200	200	180	197		
	D°	293	310	244	257	280	272		

Panel cut-out

Square flange receptacle (Type 0)

Jam nut receptacle (Type 7)

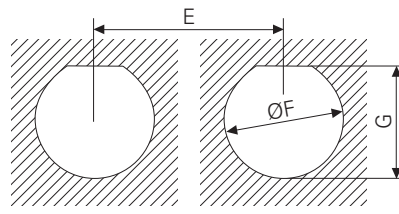
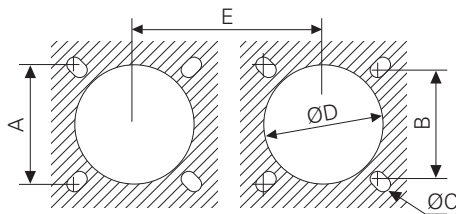

Shell size	A	B	C ^{+0.13}	D min.		E min.	F ^{+0.25} ₀	G
				Rear mounting	Front mounting			
9 (A)	18.26	15.09	3.25	16.66	13.11	31.80	17.60	16.70
11 (B)	20.62	18.26	3.25	20.22	15.88	35.00	20.96	19.59
13 (C)	23.01	20.62	3.25	23.42	19.05	39.40	25.65	24.26
15 (D)	24.61	23.01	3.25	26.59	23.01	42.50	28.83	27.56
17 (E)	26.97	24.61	3.25	30.96	25.81	45.70	32.01	30.73
19 (F)	29.36	26.97	3.25	32.94	28.98	48.50	35.18	33.91
21 (G)	31.75	29.36	3.25	36.12	32.16	51.70	38.35	37.08
23 (H)	34.93	31.75	3.91	39.29	34.93	54.90	41.53	40.26
25 (J)	38.10	34.93	3.91	42.47*	37.69	58.00	44.70	43.43

* For Type 0 composite shell rear mounting: 43.77 mm.

Max. panel thickness for receptacle: Type 0: front mounting = 3.2 mm, rear mounting = 2.5 mm

Type 7: 3.2 mm

Note: All dimensions are in millimeters (mm).

Coordinates for straight PC tail terminations

Viewed from front face of male insulator

Hole sizes: 1mm min. (#22 and #20 contacts) and 1.3mm min. (#16 contact) coordinates in mm.

09 / A

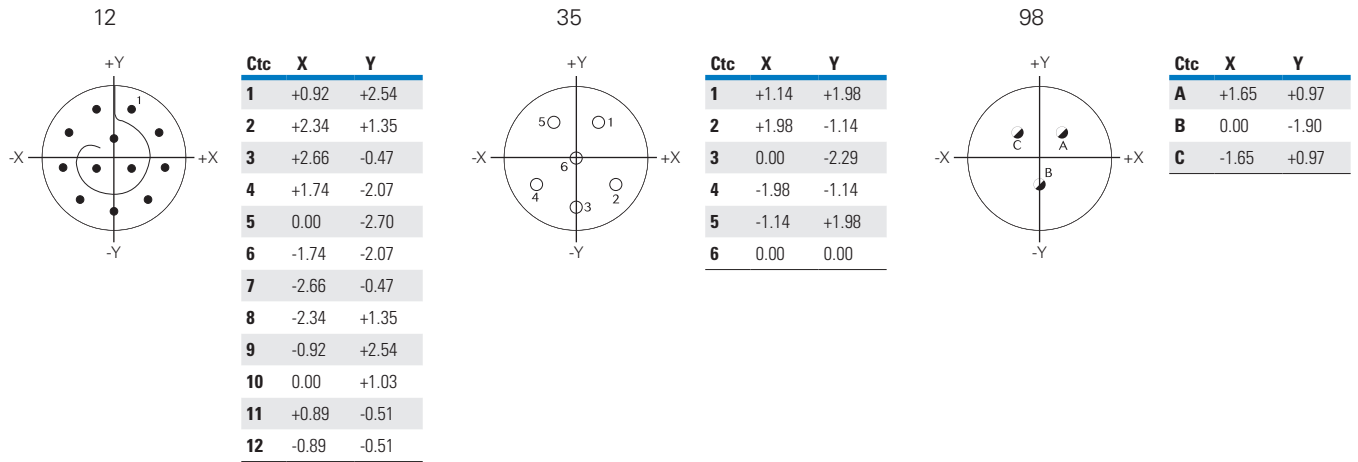

11 / B

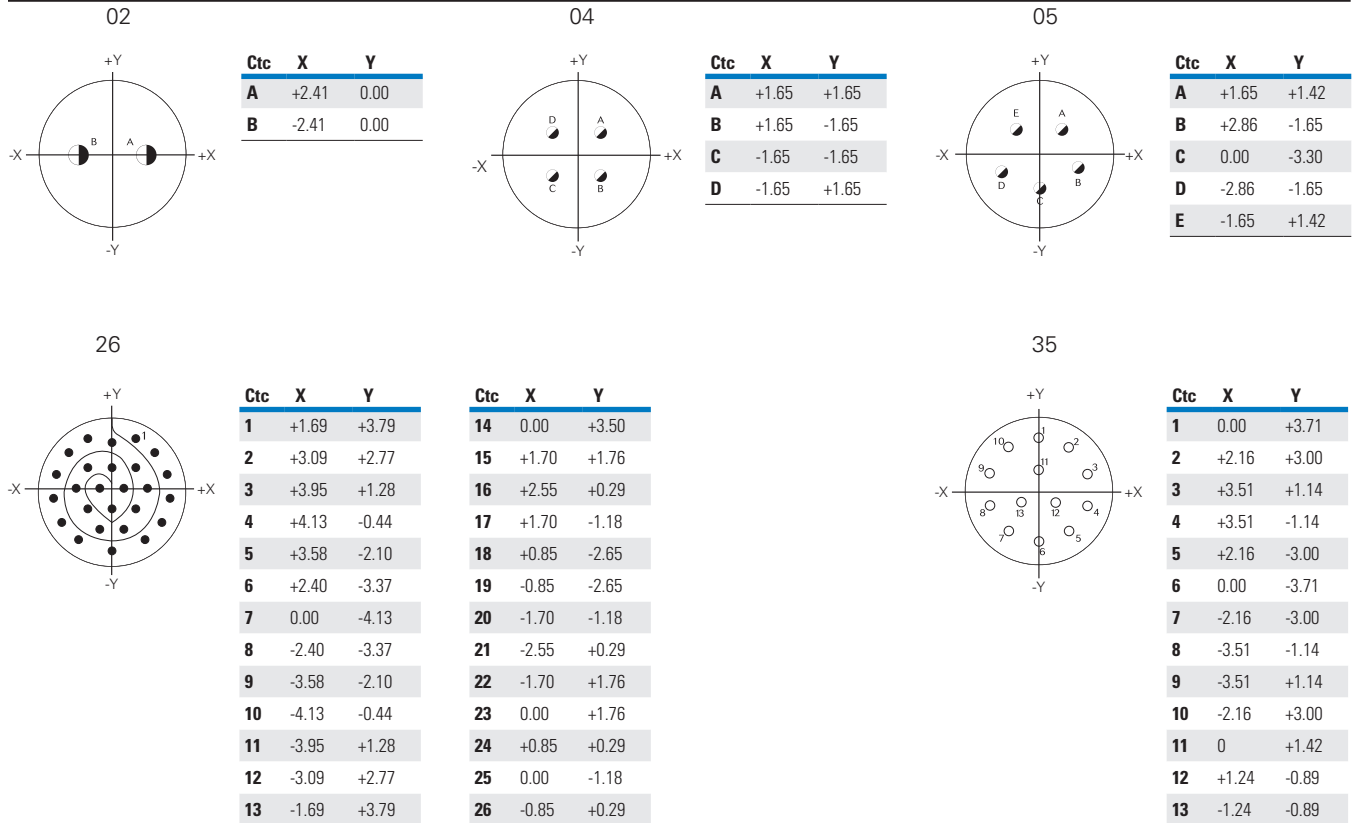

Souriau 8D series

Coordinates

11 / B

98

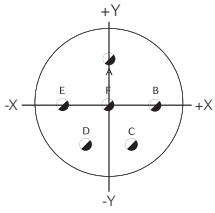

Ctc	X	Y
A	0.00	+3.30
B	+3.30	0.00
C	+1.65	-2.87
D	-1.65	-2.87
E	-3.30	0.00
F	0.00	0.00

99

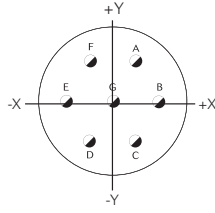

Ctc	X	Y
A	+1.65	+2.85
B	+3.30	0.00
C	+1.65	-2.87
D	-1.65	-2.87
E	-3.30	0.00
F	-1.65	+2.87
G	0.00	0.00

13 / C

04

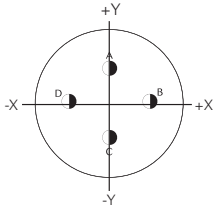

Ctc	X	Y
A	0.00	+3.81
B	+3.71	+0.89
C	0.00	-2.11
D	-3.71	+0.89

08

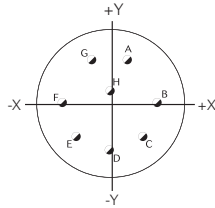

Ctc	X	Y
A	+1.65	+3.99
B	+4.32	0.00
C	+3.05	-3.05
D	0.00	-4.32
E	-3.05	-3.05
F	-4.32	0.00
G	-1.65	+3.99
H	0.00	+1.12

35

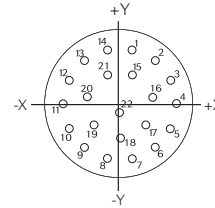

Ctc	X	Y
8	-1.14	-5.00
9	-3.20	-4.01
10	-4.62	-2.24
11	-5.16	0.00
12	-4.62	+2.24
13	-3.20	+4.01
14	-1.14	+5.00
15	+1.14	+2.72
16	+2.97	+0.66
17	+2.36	-1.91
18	0.00	-3.05
19	-2.36	-1.91
20	-2.97	+0.66
21	-1.14	+2.72
22	0.00	-0.76

Ctc	X	Y
1	+1.14	+5.00
2	+3.20	+4.01
3	+4.62	+2.24
4	+5.16	0.00
5	+4.62	-2.24
6	+3.20	-4.01
7	+1.14	-5.00

43

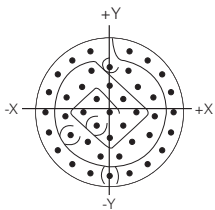

Ctc	X	Y
12	-3.42	-4.71
13	-4.71	-3.42
14	-5.54	-1.80
15	-5.82	0.00
16	-5.54	+1.80
17	-4.71	+3.42
18	-3.42	+4.71
19	-1.80	+5.54
20	0.00	+4.12
21	+1.68	+3.76
22	+2.54	+2.28
23	+3.92	+1.27
24	+4.10	-0.43
25	+3.57	-2.06
26	+1.99	-2.74
27	+0.86	-4.03
28	-0.86	-4.03
29	-1.99	-2.74
30	-3.57	-2.06
31	-4.10	-0.43
32	-3.92	+1.27
33	-2.54	+2.28
34	-1.68	+3.76
35	0.00	+2.42
36	+1.21	+1.21
37	+2.42	0.00
38	+1.21	-1.21
39	0.00	-2.42
40	-1.21	-1.21
41	-2.42	0.00
42	-1.21	+1.21
43	0.00	0.00

Ctc	X	Y
1	+1.80	+5.54
2	+3.42	+4.71
3	+4.71	+3.42
4	+5.54	+1.80
5	+5.82	0.00
6	+5.54	-1.80
7	+4.71	-3.42
8	+3.42	-4.71
9	+1.80	-5.54
10	0.00	-5.82
11	-1.80	-5.54

98

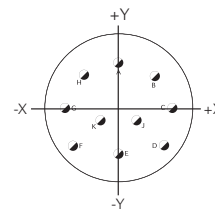

Ctc	X	Y
A	0.00	+4.95
B	+3.18	+3.81
C	+4.90	+0.76
D	+4.17	-2.67
E	0.00	-3.43
F	-4.17	-2.67
G	-4.90	+0.76
H	-3.18	+3.81
J	+1.65	-0.38
K	-1.65	-0.38

15 / D

05

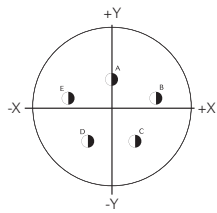

Ctc	X	Y
A	0	+2.54
B	+4.42	+0.61
C	+2.39	-3.76
D	-2.39	-3.76
E	-4.42	+0.61

18

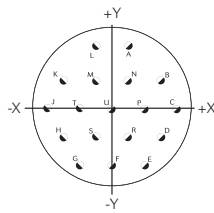

Ctc	X	Y
A	+1.65	+6.40
B	+4.95	+2.87
C	+6.60	0.00
D	+4.95	-2.87
E	+3.30	-5.72
F	0.00	-5.72
G	-3.30	-5.72
H	-4.95	-2.87
J	-6.60	0.00
K	-4.95	+2.87
L	-1.65	+6.40
M	-1.65	+2.87
N	+1.65	+2.87
P	+3.30	0.00
R	+1.65	-2.87
S	-1.65	-2.87
T	-3.30	0.00
U	0.00	0.00

19

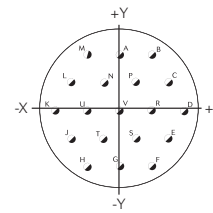

Ctc	X	Y
A	0.00	+5.72
B	+3.30	+5.72
C	+4.95	+2.87
D	+6.60	0.00
E	+4.95	-2.87
F	+3.30	-5.72
G	0.00	-5.72
H	-3.30	-5.72
J	-4.95	-2.87
K	-6.60	0.00
L	-4.95	+2.87
M	-3.30	+5.72
N	-1.65	+2.87
P	+1.65	+2.87
R	+3.30	0.00
S	+1.65	-2.87
T	-1.65	-2.87
U	-3.30	0.00
V	0.00	0.00

97

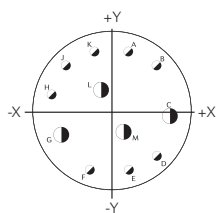

Ctc	X	Y
A	+1.65	+5.94
B	+4.52	+4.52
C	+5.84	-0.58
D	+4.52	-4.52
E	+1.65	-5.94
F	-2.26	-5.97
G	-5.26	-2.41
H	-5.94	+1.65
J	-4.52	+4.52
K	-1.65	+5.94
L	-1.19	+2.06
M	+1.19	-2.06

35

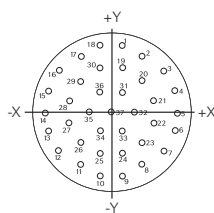

Ctc	X	Y
1	+1.14	+6.65
2	+3.12	+5.51
3	+5.36	+4.06
4	+6.45	+2.03
5	+6.76	-0.25
6	+6.27	-2.49
7	+5.08	-4.45
8	+3.30	-5.89
9	+1.14	-6.65
10	-1.14	-6.65
11	-3.30	-5.89
12	-5.08	-4.45
13	-6.27	-2.49
14	-6.76	-0.25
15	-6.45	+2.03
16	-5.36	+4.06
17	-3.12	+5.51
18	-1.14	+6.65
19	+1.14	+4.37

Ctc	X	Y
20	+3.12	+3.02
21	+4.32	+1.02
22	+4.32	-1.27
23	+3.12	-3.23
24	+1.14	-4.37
25	-1.14	-4.37
26	-3.12	-3.23
27	-4.32	-1.27
28	-4.32	+1.02
29	-3.12	+3.02
30	-1.14	+4.37
31	+1.14	+1.88
32	+2.29	-0.10
33	+1.14	-2.08
34	-1.14	-2.08
35	-2.29	-0.10
36	-1.14	+1.88
37	0.00	-0.10

Souriau 8D series

Coordinates

17/E

06

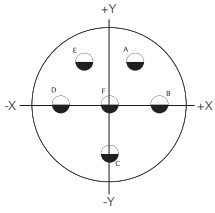

Ctc	X	Y
A	+3.07	+5.31
B	+6.12	0.00
C	0.00	-6.12
D	-6.12	0.00
E	-3.07	+5.31
F	0.00	0.00

08

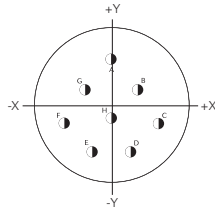

Ctc	X	Y
A	0.00	+5.99
B	+3.25	+2.18
C	+5.84	-1.98
D	+2.39	-5.49
E	-2.39	-5.49
F	-5.84	-1.98
G	-3.25	+2.18
H	0.00	-1.32

26

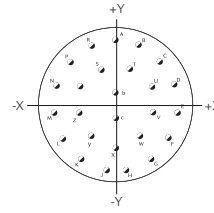

Ctc	X	Y
A	0.00	+8.15
B	+3.33	+7.44
C	+6.07	+5.44
D	+7.75	+2.51
E	+8.10	-0.86
F	+7.06	-4.09
G	+4.80	-6.60
H	+1.70	-7.98
J	-1.70	-7.98

Ctc	X	Y
K	-4.80	-6.60
L	-7.06	-4.09
M	-8.10	-0.86
N	-7.75	+2.51
P	-6.07	+5.44
R	-3.33	+7.44
S	-1.78	+4.50
T	+1.78	+4.50
U	+4.45	+2.39
V	+4.53	-0.91
W	+3.02	-3.84
X	0.00	-5.16
Y	-3.02	-3.84
Z	-4.53	-0.91
a	-4.45	+2.39
b	0.00	+1.65
c	0.00	-1.65

35

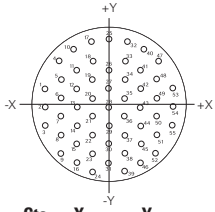

Ctc	X	Y
1	-7.92	+2.18
2	-7.92	-0.10
3	-7.92	-2.39
4	-6.15	+5.61
5	-5.94	+3.33
6	-5.94	+1.04
7	-5.94	-1.24
8	-5.94	-3.53
9	-5.94	-5.82
10	-4.37	+7.09
11	-3.96	+4.47
12	-3.96	+2.18
13	-3.96	-0.10
14	-3.96	-2.39
15	-3.96	-4.67
16	-3.96	-6.96
17	-2.26	+8.03
18	-1.98	+5.61
19	-1.98	+3.33
20	-1.98	+1.04
21	-1.98	-1.24
22	-1.98	-3.53
23	-1.98	-5.82
24	-1.98	-8.10

Ctc	X	Y
25	0.00	+8.36
26	0.00	+4.47
27	0.00	+2.18
28	0.00	-0.10
29	0.00	-2.39
30	0.00	+4.67
31	0.00	-6.96
32	+2.26	+8.03
33	+1.98	+5.61
34	+1.98	+3.33
35	+1.98	+1.04
36	+1.98	-1.24
37	+1.98	-3.53
38	+1.98	-5.82
39	+1.98	-8.10
40	+4.37	+7.09
41	+3.96	+4.47
42	+3.96	+2.18
43	+3.96	-0.10
44	+3.96	-2.39
45	+3.96	-4.67
46	+3.96	-6.96
47	+6.15	+5.61
48	+5.94	+3.33
49	+5.94	+1.04
50	+5.94	-1.24
51	+5.94	-3.53
52	+5.94	-5.82
53	+7.92	+2.18
54	+7.92	-0.10
55	+7.92	-2.39

99

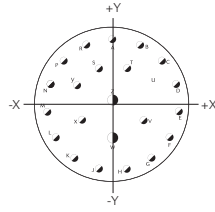

Ctc	X	Y
A	0.00	+8.15
B	+3.33	+7.44
C	+6.07	+5.44
D	+7.75	+2.51
E	+8.10	-0.86
F	+7.06	-4.09
G	+4.80	-6.60
H	+1.70	-7.98
J	-1.70	-7.98
K	-4.80	-6.60
L	-7.06	-4.09
M	-8.10	-0.86
N	-7.75	+2.51
P	-6.07	+5.44
R	-3.33	+7.44
S	-1.78	+4.50
T	+1.78	+4.50
U	+4.45	+2.39
V	+3.81	-1.91
W	0.00	-4.09
X	-3.81	-1.91
Y	-4.45	+2.39
Z	0.00	+0.64

19 / F

11

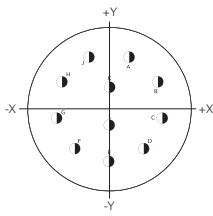

Ctc	X	Y
A	+2.67	+6.60
B	+6.35	+3.35
C	+6.99	-1.35
D	+4.55	-5.46
E	0.00	-7.14
F	-4.55	-5.46
G	-6.99	-1.35
H	-6.35	+3.35
J	-2.67	+6.60
K	0.00	+2.67
L	0.00	-2.34

32

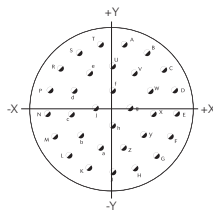

Ctc	X	Y
A	+1.68	+8.97
B	+4.80	+7.75
C	+7.26	+5.51
D	+8.76	+2.49
E	+9.07	-0.84
F	+8.15	-4.06
G	+6.15	-6.73
H	+3.30	-8.51
J	0.00	-9.12
K	-3.30	-8.51
L	-6.15	-6.73
M	-8.15	-4.06
N	-9.07	-0.84
P	-8.76	+2.49
R	-7.26	+5.51
S	-4.80	+7.75

Ctc	X	Y
T	-1.68	+8.97
U	0.00	+5.84
V	+3.15	+4.90
W	+5.31	+2.41
X	+5.79	-0.84
Y	+4.42	-3.84
Z	+1.65	-5.61
a	-1.65	-5.61
b	-4.42	-3.84
c	-5.79	-0.84
d	-5.31	+2.41
e	-3.15	+4.90
f	0.00	+2.44
g	+2.44	0.00
h	0.00	-2.44
j	-2.44	0.00

35

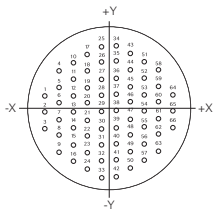

Ctc	X	Y
1	-9.07	+2.29
2	-9.07	0.00
3	-9.07	-2.29
4	-7.09	+5.71
5	-7.09	+3.43
6	-7.09	+1.14
7	-7.09	-1.14
8	-7.09	-3.43
9	-7.09	-5.71
10	-5.11	+6.86
11	-5.11	+4.57
12	-5.11	+2.29
13	-5.11	0.00
14	-5.11	-2.29

Ctc	X	Y
15	-5.11	-4.57
16	-5.11	-6.86
17	-3.12	+8.00
18	-3.12	+5.71
19	-3.12	+3.43
20	-3.12	+1.14
21	-3.12	-1.14
22	-3.12	-3.43
23	-3.12	-5.71
24	-3.12	-8.00
25	-1.14	+9.14
26	-1.14	+6.86
27	-1.14	+4.57

Ctc	X	Y
28	-1.14	+2.29
29	-1.14	0.00
30	-1.14	-2.29
31	-1.14	-4.57
32	-1.14	-6.86
33	-1.14	-9.14
34	+1.14	+9.14
35	+1.14	+6.86
36	+1.14	+4.57
37	+1.14	+2.29
38	+1.14	0.00
39	+1.14	-2.29
40	+1.14	-4.57

Ctc	X	Y
41	+1.14	-6.86
42	+1.14	-9.14
43	+3.12	+8.00
44	+3.12	+5.71
45	+3.12	+3.43
46	+3.12	+1.14
47	+3.12	-1.14
48	+3.12	-3.43
49	+3.12	-5.71
50	+3.12	-8.00
51	+5.11	+6.86
52	+5.11	+4.57
53	+5.11	+2.29

Ctc	X	Y
54	+5.11	0.00
55	+5.11	-2.29
56	+5.11	-4.57
57	+5.11	-6.86
58	+7.09	+5.71
59	+7.09	+3.43
60	+7.09	+1.14
61	+7.09	-1.14
62	+7.09	-3.43
63	+7.09	-5.71
64	+9.07	+2.29
65	+9.07	0.00
66	+9.07	-2.29

Souriau 8D series

Coordinates

21 / G

16

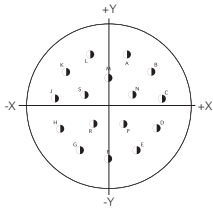

Ctc	X	Y
A	+3.00	+8.18
B	+6.88	+5.36
C	+8.66	+0.91
D	+7.82	-3.81
E	+4.62	-7.37
F	0.00	-8.71
G	-4.62	-7.37
H	-7.82	-3.81
J	-8.66	+0.91
K	-6.88	+5.36
L	-3.00	+8.18
M	0.00	+4.45
N	+3.91	+1.57
P	+2.39	-3.10
R	-2.39	-3.10
S	-3.91	+1.57

35

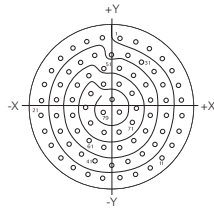

Ctc	X	Y
1	+1.35	+10.82
2	+3.71	+10.26
3	+5.89	+9.19
4	+7.77	+7.67
5	+9.27	+5.77
6	+10.31	+3.58
7	+10.85	+1.22
8	+10.85	-1.22
9	+10.31	-3.58
10	+9.27	-5.77
11	+7.77	-7.67
12	+5.89	-9.19
13	+3.71	-10.26

Ctc	X	Y
14	+1.35	-10.82
15	-1.35	-10.82
16	-3.71	-10.26
17	-5.89	-9.19
18	-7.77	-7.67
19	-9.27	-5.77
20	-10.31	-3.58
21	-10.85	-1.22
22	-10.85	+1.22
23	-10.31	+3.58
24	-9.27	+5.77
25	-7.77	+7.67
26	-5.89	+9.19
27	-3.71	+10.26
28	-1.35	+10.82
29	0.00	+8.20
30	+2.49	+8.18
31	+4.67	+7.11
32	+6.55	+5.59
33	+7.90	+3.58
34	+8.43	+1.22
35	+8.43	-1.22

Ctc	X	Y
36	+7.90	-3.58
37	+6.55	-5.59
38	+4.67	-7.11
39	+2.49	-8.18
40	0.00	-8.81
41	-2.49	-8.18
42	-4.67	-7.11
43	-6.55	-5.59
44	-7.90	-3.58
45	-8.43	-1.22
46	-8.43	+1.22
47	-7.90	+3.58
48	-6.55	+5.59
49	-4.67	+7.11
50	-2.49	+8.18
51	-1.22	+6.12
52	+1.22	+6.12
53	+3.40	+5.05
54	+5.28	+3.53
55	+6.02	+1.22
56	+6.02	-1.22
57	+5.28	-3.53

Ctc	X	Y
58	+3.40	-5.05
59	+1.22	-6.12
60	-1.22	-6.12
61	-3.40	-5.05
62	-5.28	-3.53
63	-6.02	-1.22
64	-6.02	+1.22
65	-5.28	+3.53
66	-3.40	+5.05
67	-1.22	+3.71
68	+1.22	+3.71
69	+3.18	+2.29
70	+3.94	0.00
71	+3.18	-2.29
72	+1.22	-3.71
73	-1.22	-3.71
74	-3.18	-2.29
75	-3.94	0.00
76	-3.18	+2.29
77	0.00	+1.35
78	+1.22	-0.74
79	-1.22	-0.74

39

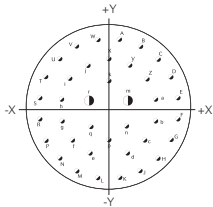

Ctc	X	Y
S	-10.44	+1.65
T	-9.42	+4.80
U	-7.47	+7.47
V	-4.80	+9.42
W	-1.65	+10.44
X	0.00	+7.49
Y	+3.20	+6.50
Z	+5.89	+4.55
A	+7.11	+1.45
B	+7.11	-1.88
C	+5.51	-4.80
D	+2.84	-6.73
E	-2.84	-6.73
F	-5.51	-4.80
G	-7.11	-1.88
H	-7.11	+1.45
I	-5.89	+4.55
J	-3.20	+6.50
K	0.00	+4.17
M	+2.90	+1.22
N	+2.69	-2.72
P	0.00	-4.80
Q	-2.69	-2.72
R	-2.90	+1.22

41

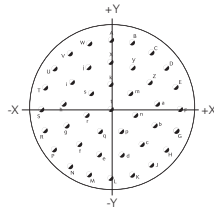

Ctc	X	Y
A	0.00	+10.60
B	+3.28	+10.09
C	+6.23	+8.58
D	+8.58	+6.23
E	+10.09	+3.28
F	+10.60	0.00
G	+10.09	-3.28
H	+8.58	-6.23
J	+6.23	-8.58
K	+3.28	-10.09
L	0.00	-10.60
M	-3.26	-10.09
N	-6.23	-8.58
P	-8.58	-6.23
R	-10.09	-3.28
S	-10.60	0.00
T	-10.09	+3.28
U	-8.58	+6.23
V	-6.23	+8.58
W	-3.28	+10.09
X	0.00	+7.20

Ctc	X	Y
Y	+3.35	+6.38
Z	+5.92	+4.09
A	+7.15	+0.87
B	+6.73	-2.55
C	+4.78	-5.39
D	+1.73	-6.99
E	-1.73	-6.99
F	-4.78	-5.39
G	-6.73	-2.55
H	-7.15	+0.87
I	-5.92	+4.09
J	-3.35	+6.38
K	0.00	+3.81
M	+2.98	+2.38
N	+3.71	-0.85
P	+1.66	-3.43
Q	-1.66	-3.43
R	-3.71	-0.85
S	-2.98	+2.38
T	0.00	0.00

23 / H

21

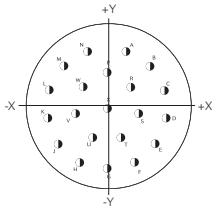

Ctc	X	Y
A	+3.25	+9.78
B	+7.34	+7.24
C	+9.80	+3.12
D	+10.16	-1.65
E	+8.33	-6.07
F	+4.65	-9.19
G	0.00	-10.31
H	-4.65	-9.19
J	-8.33	-6.07
K	-10.16	-1.65
L	-9.80	+3.12
M	-7.34	+7.24
N	-3.25	+9.78
P	0.00	+6.22
R	+4.06	+3.71
S	+5.44	-0.89
T	+2.39	-4.93
U	-2.39	-4.93
V	-5.44	-0.89
W	-4.06	+3.71
X	0.00	0.00

53

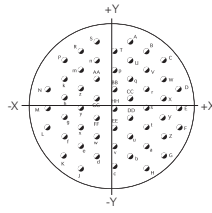

Ctc	X	Y
A	+2.84	+11.56
B	+5.72	+9.91
C	+8.53	+8.26
D	+11.43	+3.30
E	+11.43	0.00
F	+11.43	-3.30
G	+8.53	-8.26
H	+5.72	-10.41
J	-5.72	-10.41
K	-8.53	-8.26
L	-11.43	-3.30
M	-11.43	0.00
N	-11.43	+3.30
P	-8.53	+8.26
R	-5.72	+9.91
S	-2.84	+11.56
T	0.00	+9.91
U	+2.84	+8.26
V	+5.72	+6.60
W	+8.53	+4.95

Ctc	X	Y
X	+8.53	+1.65
Y	+8.53	-1.65
Z	+8.53	-4.95
A	+5.72	-6.60
B	+2.84	-8.26
C	0.00	-9.91
D	-2.84	-8.26
E	-5.72	-6.60
F	-8.53	-4.95
G	-8.53	-1.65
H	-8.53	+1.65
K	-8.53	+4.95
M	-5.72	+6.60
N	-2.84	+8.26
P	0.00	+6.60
Q	+2.84	+4.95
R	+5.72	+3.30
S	+5.72	0.00
T	+5.72	-3.30
U	+2.84	-4.95

Ctc	X	Y
V	0.00	-6.60
W	-2.84	-4.95
X	-5.72	-3.30
Y	-5.72	0.00
Z	-5.72	+3.30
AA	-2.84	+4.95
BB	0.00	+3.30
CC	+2.84	+1.65
DD	+2.84	-1.65
EE	0.00	-3.30
FF	-2.84	-1.65
GG	-2.84	+1.65
HH	0.00	0.00

25 / J

04

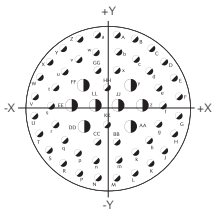

Ctc	X	Y
A	+1.75	+13.49
B	+5.16	+12.57
C	+8.23	+10.80
D	+10.77	+8.28
E	+12.52	+5.21
F	+13.49	+1.75
G	+13.49	-1.75
H	+12.52	-5.21
J	+10.77	-8.28
K	+8.23	-10.80
L	+5.16	-12.57
M	+1.75	-13.49
N	-1.75	-13.49
P	-5.16	-12.57

Ctc	X	Y
R	-8.23	-10.80
S	-10.77	-8.28
T	-12.52	-5.21
U	-13.49	-1.75
V	-13.49	+1.75
W	-12.52	+5.21
X	-10.77	+8.28
Y	-8.23	+10.80
Z	-5.16	+12.57
A	-1.75	+13.49
B	+2.18	+10.08
C	+5.38	+8.78
D	+7.90	+6.38
E	+9.58	+3.35
F	+10.46	0.00
G	+9.58	-3.35
H	+7.90	-6.38
K	+5.38	-8.78
M	+2.18	-10.08
N	-2.18	-10.08
P	-5.38	-8.78

Ctc	X	Y
Q	-7.90	-6.38
R	-9.58	-3.35
S	-10.46	0.00
T	-9.58	+3.35
U	-7.90	+6.38
V	-5.38	+8.78
W	-2.18	+10.08
X	+1.75	+6.66
Y	+4.37	+3.78
Z	+6.55	0.00
AA	+4.37	-3.78
BB	+1.75	-6.66
CC	-1.75	-6.66
DD	-4.37	-3.78
EE	-6.55	0.00
FF	-4.37	-3.78
GG	-1.75	+6.66
HH	0.00	+3.35
JJ	+2.18	0.00
KK	0.00	-3.35
LL	-2.18	0.00

29

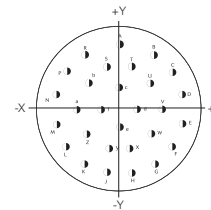

Ctc	X	Y
A	0.00	+12.22
B	+6.55	+10.31
C	+10.03	+7.04
D	+11.91	+2.77
E	+11.91	-2.77
F	+10.03	-7.04
G	+6.68	-10.31
H	+2.31	-11.99

Ctc	X	Y
J	-2.31	-11.99
K	-6.68	-10.31
L	-10.03	-7.04
M	-11.91	-2.77
N	-11.91	+2.77
P	-10.03	+7.04
R	-6.55	+10.31
S	-2.31	+8.15
T	+2.31	+8.15
U	+5.79	+4.93
V	+8.10	0.00
W	+6.10	-4.60
X	+2.31	-7.37
Y	-2.31	-7.37
Z	-6.10	-4.60
A	-8.10	0.00
B	-5.79	+4.93
C	0.00	+4.09
D	+3.40	0.00
E	0.00	-3.30
F	-3.40	0.00

Souriau 8D series

Coordinates

25 / J

35

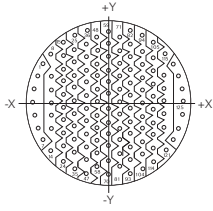

Ctc	X	Y
1	-12.17	+7.09
2	-13.21	+4.83
3	-13.87	+2.41
4	-14.10	0.00
5	-13.87	-2.41
6	-13.21	-4.83
7	-12.17	-7.09
8	-10.77	+9.07
9	-10.54	+4.83
10	-10.54	+2.41
11	-10.54	0.00
12	-10.54	-2.41
13	-10.54	-4.83
14	-10.77	-9.07
15	-8.43	+11.28
16	-8.43	+8.43
17	-8.43	+6.02
18	-8.43	+3.61
19	-8.43	+1.19
20	-8.43	-1.19
21	-8.43	-3.61
22	-8.43	-6.02
23	-8.43	-8.43
24	-8.43	-10.85
25	-6.32	+12.60
26	-6.32	+9.65

Ctc	X	Y
27	-6.32	+7.24
28	-6.32	+4.83
29	-6.32	+2.41
30	-6.32	0.00
31	-6.32	-2.41
32	-6.32	-4.83
33	-6.32	-7.24
34	-6.32	-9.65
35	-6.32	-12.07
36	-4.06	+13.49
37	-4.22	+10.85
38	-4.22	+8.43
39	-4.22	+6.02
40	-4.22	+3.61
41	-4.22	+1.19
42	-4.22	-1.19
43	-4.22	-3.61
44	-4.22	-6.02
45	-4.22	-8.43
46	-4.22	-10.85
47	-4.22	-13.26
48	-2.11	+12.07
49	-2.11	+9.65
50	-2.11	+7.24
51	-2.11	+4.83
52	-2.11	+2.41

Ctc	X	Y
53	-2.11	0.00
54	-2.11	-2.41
55	-2.11	-4.83
56	-2.11	-7.24
57	-2.11	-9.65
58	-2.11	-12.07
59	0.00	+13.26
60	0.00	+10.85
61	0.00	+8.43
62	0.00	+6.02
63	0.00	+3.61
64	0.00	+1.19
65	0.00	-1.19
66	0.00	-3.61
67	0.00	-6.02
68	0.00	-8.43
69	0.00	-10.85
70	0.00	-14.10
71	+2.11	+12.07
72	+2.11	+9.65
73	+2.11	+7.24
74	+2.11	+4.83
75	+2.11	+2.41
76	+2.11	0.00
77	+2.11	-2.41
78	+2.11	-4.83

Ctc	X	Y
79	+2.11	-7.24
80	+2.11	-9.65
81	+2.11	-12.07
82	+4.06	+13.49
83	+4.22	+10.85
84	+4.22	+8.43
85	+4.22	+6.02
86	+4.22	+3.61
87	+4.22	+1.19
88	+4.22	-1.19
89	+4.22	-3.61
90	+4.22	-6.02
91	+4.22	-8.43
92	+4.22	-10.85
93	+4.22	-13.26
94	+6.32	+12.60
95	+6.32	+9.65
96	+6.32	+7.24
97	+6.32	+4.83
98	+6.32	+2.41
99	+6.32	0.00
100	+6.32	-2.41
101	+6.32	-4.83
102	+6.32	-7.24
103	+6.32	-9.65

Ctc	X	Y
104	+6.32	-12.07
105	+8.43	+11.28
106	+8.43	+8.43
107	+8.43	+6.02
108	+8.43	+3.61
109	+8.43	+1.19
110	+8.43	-1.19
111	+8.43	-3.61
112	+8.43	-6.02
113	+8.43	-8.43
114	+8.43	-10.85
115	+10.77	+9.07
116	+10.54	+4.83
117	+10.54	+2.41
118	+10.54	0.00
119	+10.54	-2.41
120	+10.54	-4.83
121	+10.77	-9.07
122	+12.17	+7.09
123	+13.21	+4.83
124	+13.87	+2.41
125	+14.10	0.00
126	+13.87	-2.41
127	+13.21	-4.83
128	+12.17	-7.09

43

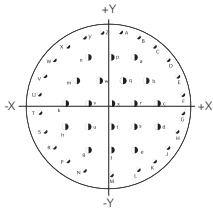

Ctc	X	Y
Y	-5.16	+12.57
Z	-1.75	+13.4
A	+4.37	+8.74
B	+6.55	+4.37
C	+8.74	0.00
D	+8.74	-4.37
E	+4.37	-8.74
F	0.00	-8.74
G	-4.37	-8.74
H	-8.74	-4.37
K	-8.74	0.00
M	-6.55	+4.37
N	-4.37	+8.74
P	0.00	+8.74
Q	+2.18	+4.37
R	+4.37	0.00
S	+4.37	-4.37
T	0.00	-4.37
U	-4.37	-4.37
V	-4.37	0.00
W	-2.18	+4.37
X	0.00	0.00

61

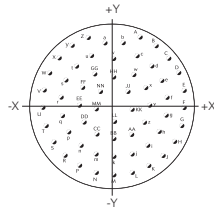

Ctc	X	Y
A	+4.98	+12.70
B	+7.98	+11.05
C	+10.49	+8.71
D	+12.32	+5.84
E	+13.39	+2.57
F	+13.61	-0.76
G	+12.98	-4.17
H	+11.53	-7.29
J	+9.35	-9.93
K	+6.58	-11.94
L	+3.40	-13.18
M	0.00	-13.64
N	-3.40	-13.18
P	-6.58	-11.94
R	-9.35	-9.93
S	-11.53	-7.29
T	-12.98	-4.17
U	-13.61	-0.76
V	-13.39	+2.57
W	-12.32	+5.84
X	-10.49	+8.71
Y	-7.98	+11.05

Ctc	X	Y
Z	-4.98	+12.10
A	-1.73	+11.53
B	+1.73	+11.53
C	+4.39	+9.22
D	+7.24	+7.19
E	+9.19	+4.45
F	+10.13	+1.17
G	+9.96	-2.24
H	+8.66	-5.41
I	+6.38	-7.98
J	+3.38	-9.63
K	0.00	-10.21
M	-3.38	-9.63
N	-6.38	-7.98
P	-8.66	-5.41
Q	-9.96	-2.24
R	-10.13	+1.17
S	-9.19	+4.45
T	-7.24	+7.19
U	-4.39	+9.22
V	0.00	+8.59

Ctc	X	Y
W	+3.73	+5.66
X	+6.02	+3.10
Y	+6.78	-0.25
Z	+5.79	-3.53
AA	+3.33	-5.92
BB	0.00	-6.78
CC	-3.33	-5.92
DD	-5.79	-3.53
EE	-6.78	-0.25
FF	-6.02	+3.10
GG	-3.73	+5.66
HH	0.00	+5.08
JJ	+2.67	+2.39
KK	+3.43	-1.04
LL	0.00	-3.35
MM	-3.43	-1.04
NN	-2.67	+2.39
PP	0.00	0.00

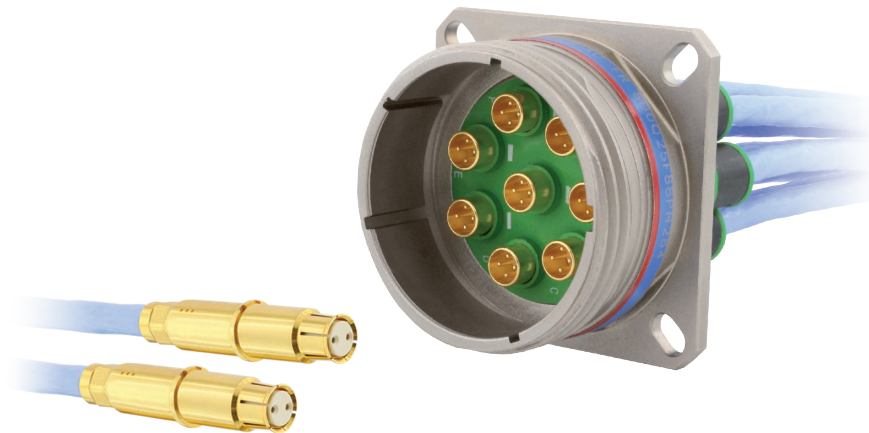

Description

High speed contacts:

- Twinax: crimp version
- Quadrax: crimp and PC tail versions
- Front and rear removable versions are available
- Characteristic impedance of 100 Ohms
- Compatible with star quad cable
- Standard #8 cavity insertion and removal tools
- Ground connection of the cable braid to the shell possible through the external shell of the #8 contact
- Mixed layouts not grounded

Mechanical

Operating temperature
-65°C up to 150°C

Inner contact
Copper alloy

Contact body
Copper alloy

Contact insulator
Thermoplastic resin

Contact plating
Gold over nickel

Shell plating

- Aluminum shell:
 - Cadmium olive drab (W)
 - Nickel (F)
 - Black zinc nickel (Z)
 - Green zinc cobalt (ZC)
 - Gray tin-zinc (with black coupling nut for plug) (SZ)
- Composite shell:
 - Cadmium olive drab (J)
 - Nickel (M)
 - Without plating (X)
- Stainless steel shell:
 - Passivated (K)
 - Nickel (S)
- Titanium shell:
 - Without plating (TT)
 - Nickel (TF)
- Bronze shell:
 - Without plating

Electrical

ISO/IEC 11801 category 6 compliant

- Next (cross talk): > 46 db at 250 MHz
- Return loss: > 16 db at 250 MHz
- Shield effectiveness: > 36 db at 80 MHz

Contact to shell continuity
< 10 mΩ

Contact resistance (low level)

- Initial 15 mΩ
- After tests 30 mΩ

Dielectric withstanding voltage

Altitude	Service I
Sea level	500 Vrms
21 000 m	125 Vrms

Insulation resistance

- At ambient temperature: > 5000 MΩ
- At high temperature: > 1000 MΩ



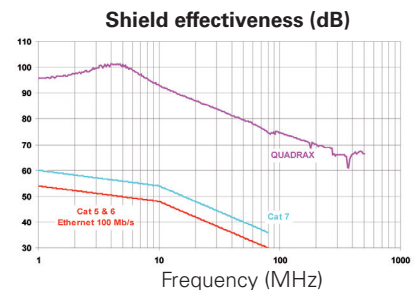
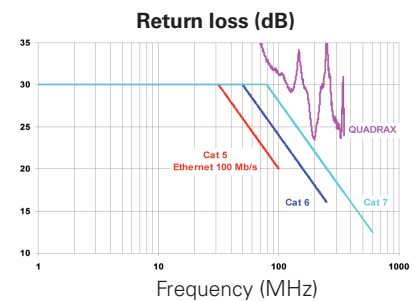
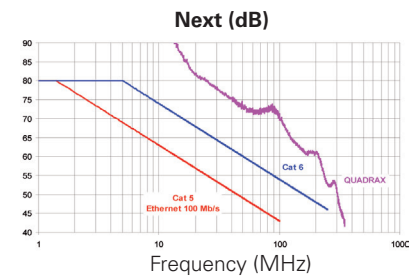

#24 contact cable size acceptance
AWG 22 to AWG 26



Souriau 8D series - twinax and Quadrax contacts

Contact layouts

Contact layouts

 Contact #22D
  Contact #20
  Contact #16
  Contact #12
  Contact #8, twinax or Quadrax

09

05*

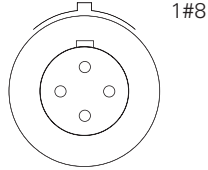

* 09-05 layout with twinax or Quadrax contact:
 - grounded version only
 - plug with female contact & receptacle with male contact only

11

81

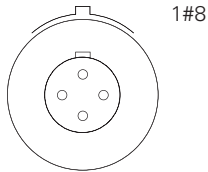

17

80

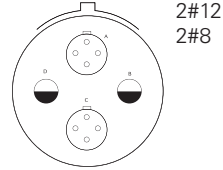

81

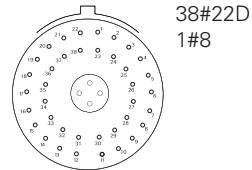

82

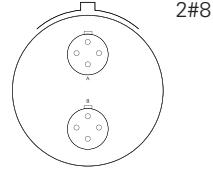

19

84

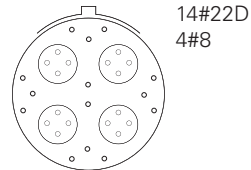

21

78

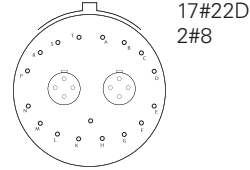

80

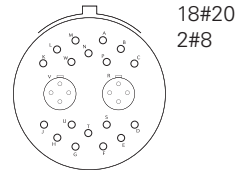

84

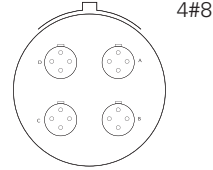

23

86

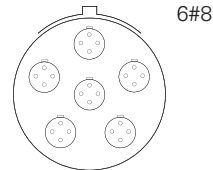

25

80

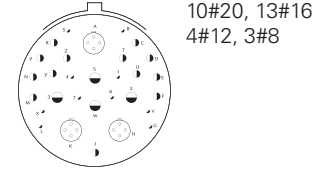

81

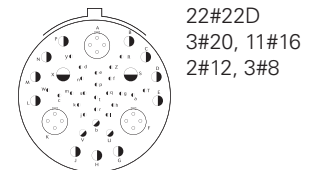

82

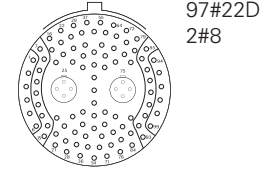

86

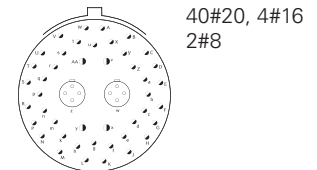

87

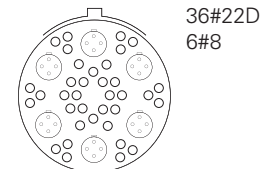

88

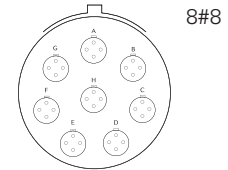

Note: Mixed layouts not grounded.

Ordering information

Aluminum, composite, stainless steel & titanium connector

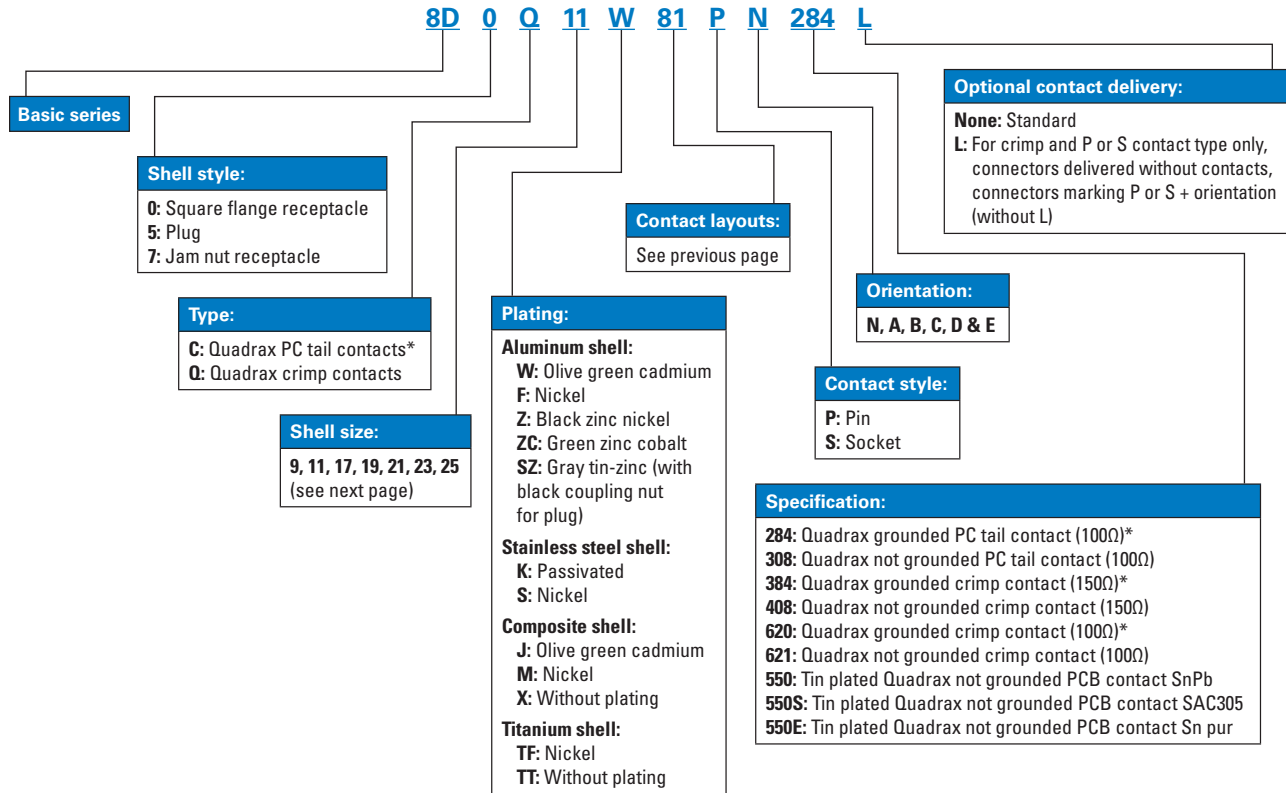

Bronze connector

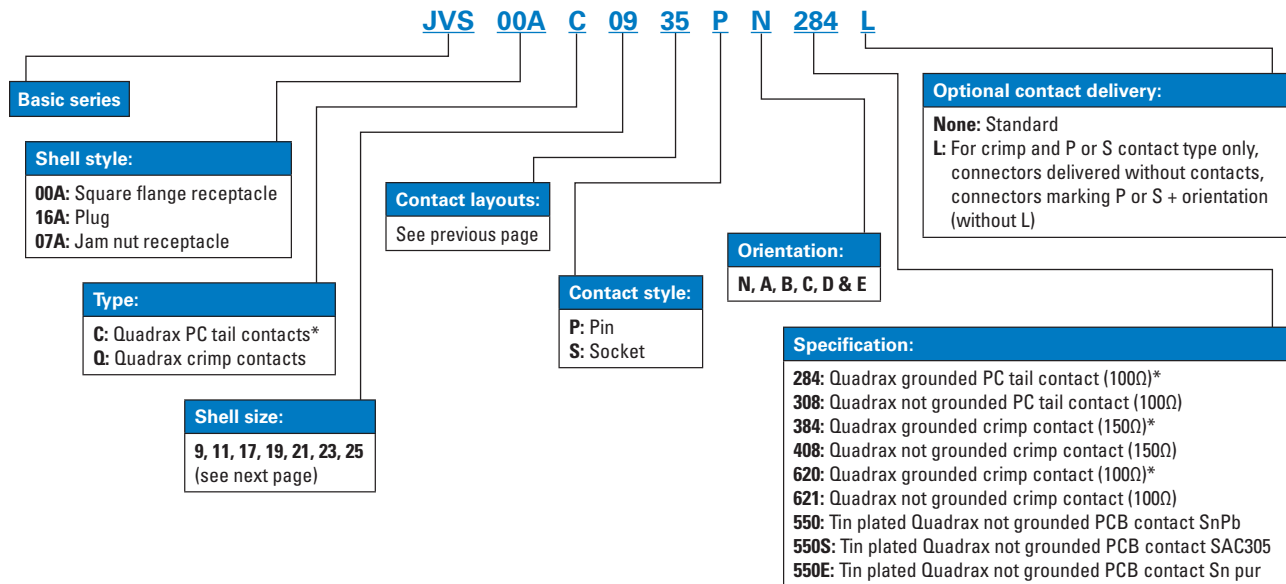

* For PC tail contacts or grounded versions please consult us.

Souriau 8D series - twinax and Quadrax contacts

Dimensions

Dimensions

Square flange receptacle - type 0

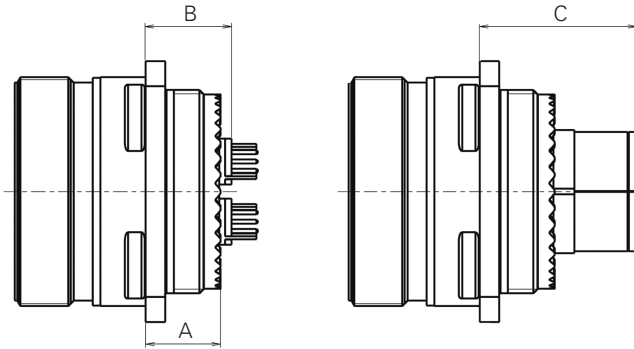

PC Tail contacts

Crimp contacts

Shell size	A Max		B Min			B Max			C Max	
	Aluminum	Composite	Stainless steel, titanium & bronze	Aluminum	Composite	Stainless steel, titanium & Bronze	Aluminum	Composite	Stainless steel, titanium & Bronze	All materials
11 to 19	10.72	11.96	11.4	11.5	12.5	12	13.5	13.5	14	29
21 to 25	11.54	12.76	11.8	12	14.5	12.5	14	15.5	14.5	30

Jam nut receptacle - type 7

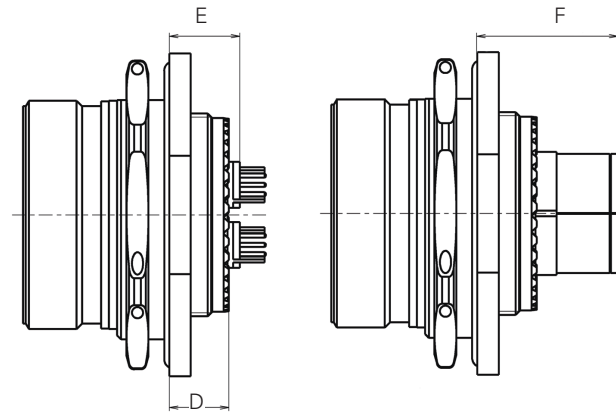

PC Tail contacts

Crimp contacts

Material	Aluminum, stainless steel, titanium & bronze			
Shell size	D Max	E Min	E Max	F Max
11 to 25	9.9	9.5	12	27

Plug - type 5

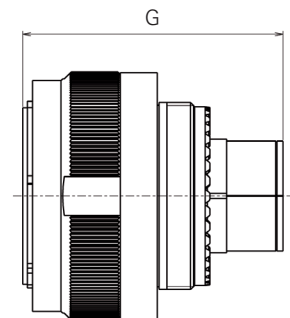

All materials	
Shell size	G Max
11 to 25	48

Note: All dimensions are in millimeters (mm).

Dimensions

Quadrax crimp contact

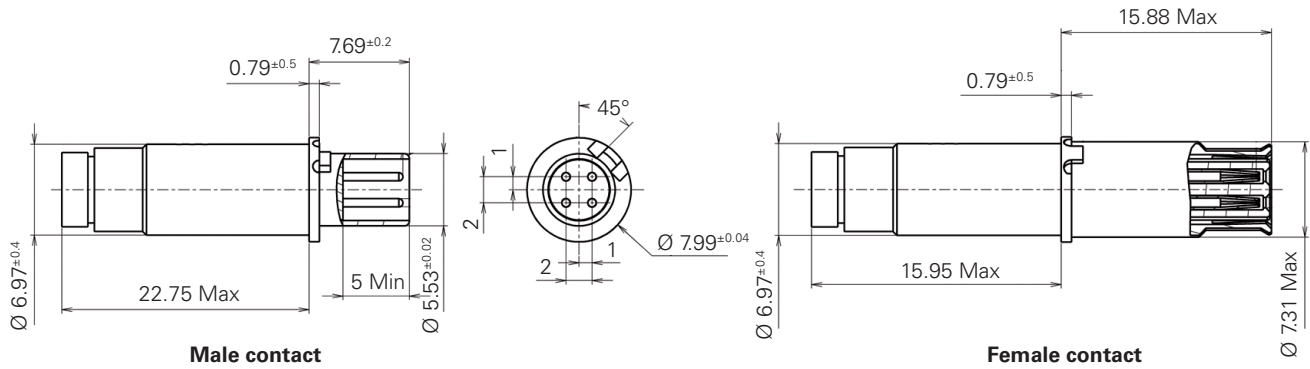

Quadrax PCB contact

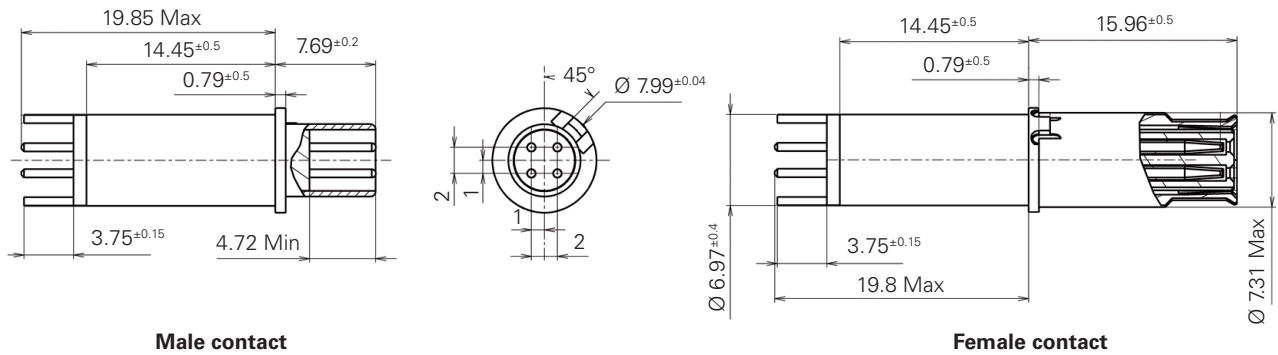

Drill dimensions for PCB mount

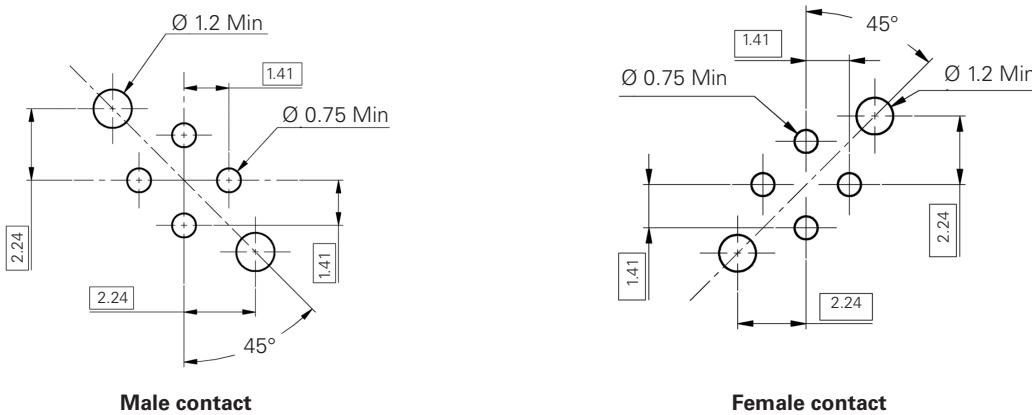

View from front face of PCB.

Note: All dimensions are in millimeters (mm).

Souriau 8D series - twinax and Quadrax contacts

Contacts and tooling

Dimensions

Twinax crimp contact

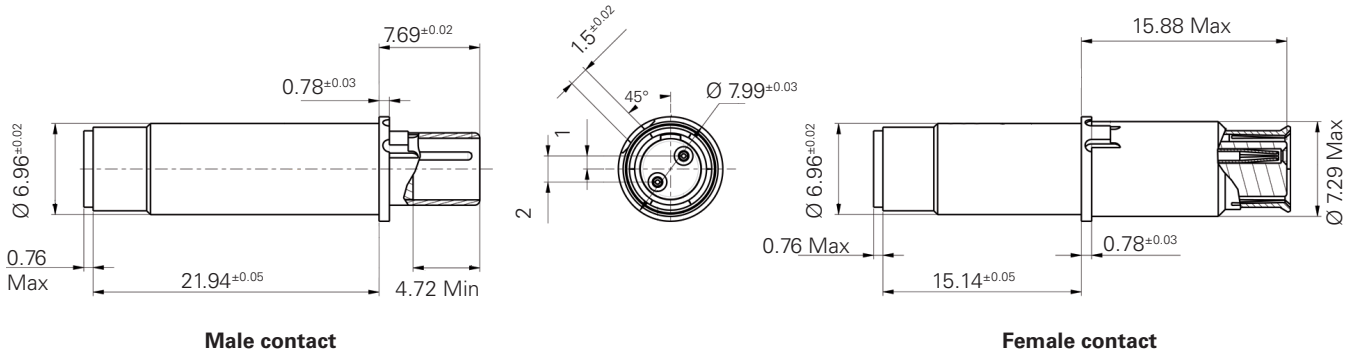

Contact ordering information

In-line alignment key. All crimp contacts are sealed thru a sealing boot. Crimp contacts ordered separately are delivered with sealing boot.

Contact type		Souriau part number	Cross norm	Impedance	Release	T° Max	
Quadrax contact	PC tail L= 4 ^{±0.1} mm	Pin	ETH1-1237A	-	100Ω	Rear	125°C
			ETH1-1501A	-	150Ω	Rear	125°C
		Socket	ETH1-1238A	-	100Ω	Rear	125°C
	Crimp	Pin	ETH1-1345A	EN 3155-074	100Ω	Rear	150°C
			ETH1-1503A	-	150Ω	Rear	150°C
		Socket	ETH1-1346A	EN 3155-075	100Ω	Rear	150°C
ETH1-1504A			-	150Ω	Rear	150°C	
Twinax contact	Crimp	Pin	ETH2-1110A	-	100Ω	Rear	150°C
		Socket	ETH2-1111A	-	100Ω	Rear	150°C

Tooling

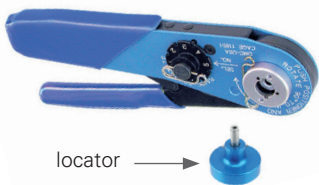

locator →

Inner contacts: M22520/2-01 crimping tool and K709 locator



Metallic tool

Insertion/extraction tool, standard size 8 cavity tools: 8660-197 (metallic) or M81969/14-06 (plastic)



die set →

Outer body: M22520/5-01 crimping tool and M22520/5-45 die set



Plastic tool

Recommended cable

Impedance	Reference	Cable type	Number of pairs
100Ω	ABS 1503 KD24	Star quad	2

Note: All dimensions are in millimeters (mm).

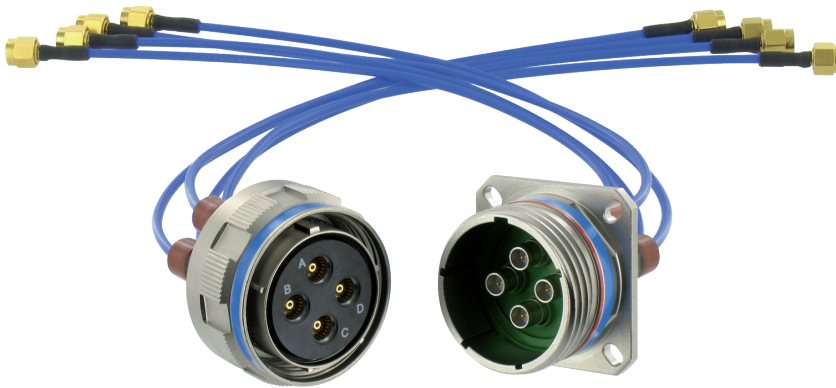

BMA contact features

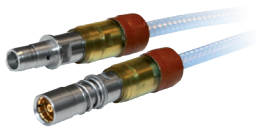

Electrical

Impedance

50Ω

Frequency range

DC 18GHz

Dielectric withstanding voltage

1.5 kVrms, 50Hz (at sea level)

Insulation resistance: ≥ 5 000 MΩ

Contact resistance

- center contact: ≤ 2 mΩ
- outer contact: ≤ 2 mΩ

Return loss (DC-18GHz)

< -17dB (mated connector)

RF leakage interface only (fully mated)

≥ 90 dB f (GHz) measured at interface with reference planes being in true alignment.

RF testing voltage

1.0 kVrms, 5 MHz (at sea level)

Admissible power

≤ 300 W at 3 GHz
(at sea level & room T°)

Environmental

Temperature range

-65°C +125°C

Thermal shock

MIL-STD-202, method 107, condition B

Moisture resistance

MIL-STD-202, method 106

Corrosion

Salt spray test according to MIL-STD-202, method 101, condition B

Vibration

MIL-STD-202, method 204, condition D

Shock

MIL-STD-202, method 213, condition I

⚠ Caution: be careful that your application doesn't exceed contact specification.

Connector specifications

Mechanical

Shell material & plating

- Aluminum:
 - Cadmium olive drab (W)
 - Nickel (F)
 - Black zinc nickel (Z)
 - Green zinc cobalt (ZC)
 - Gray tin-zinc (with black coupling nut for plug) (SZ)
- Composite:
 - Cadmium olive drab (J)
 - Nickel (M)
 - Without plating (X)
- Stainless steel:
 - Passivated (K)
 - Nickel (S)
- Titanium
 - Without plating (TT)
 - Nickel (TF)
- Bronze:
 - Without plating

Insulator

Thermoplastic

Grommet and interfacial seal

Silicone elastomer

Contact endurance

1000 mating cycles

Description

BMA coaxial contacts:

- Quick screw coupling D38999 connector
- Shells are available in aluminum, composite, stainless steel, titanium and bronze
- 16 layouts with coaxial contact qualified to MIL-STD-348A/321
- DC 18GHz high frequency coaxial contact
- Removable coaxial contact
- Contacts delivered with boots

Connector endurance

500 mating cycles

Shock

300g, 3 ms

Vibration:

- Sinus:
 - 10 à 2000 Hz, 3x12 hrs (60g, 140 - 2000 Hz) with T° cycling
- Random:
 - 50 to 2000 Hz, 2x8 hrs (1g2/ Hz, 100 - 2000Hz) at T° max.
 - 25 to 2000 Hz, 2x8 hrs (5g2/ Hz, 100 - 300Hz) at ambient T°

Electrical

Shell continuity

- F, S & TF: 1 mΩ
- J & M: 3 mΩ
- W, Z, ZC & SZ: 2.5 mΩ
- Bronze: 5 mΩ
- K & TT: 10 mΩ

Shielding

- F & M: 85 db at 1 GHz
- K & TT: 45 db at 10 GHz
- W, Z & SZ: 50 db at 10 GHz
- F, S & TF: 65 db at 10 GHz
- Bronze: 85 db at 10 GHz
- J: 90 db at 10 GHz
- ZC: Consult us

Environmental

Temperature range

- W, Z, ZC, SZ, J, X & bronze: -65°C +175°C
- F, M, K, S, TT & TF: -65°C +200°C

Salt spray

- F, S & TF: 48 hrs
- ZC: 250 hrs
- W, Z, SZ, K, TT & bronze: 500 hrs
- J, M & X: 2000 hrs

Souriau 8D series BMA coaxial contacts

Contact layouts

Contact layouts

Specification 737 mandatory

 Contact #22D
  Contact #20
  Contact #16
  Contact #12
  Contact #8 Coax

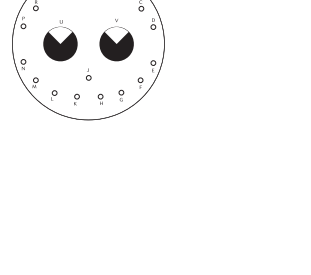
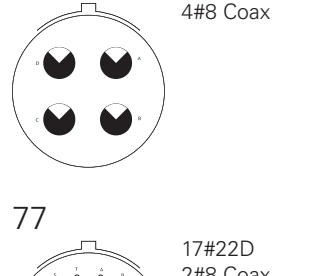
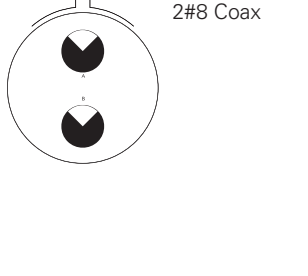
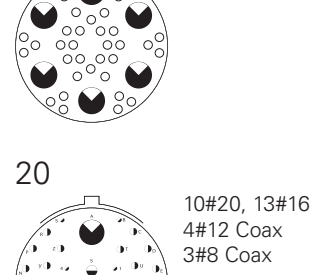
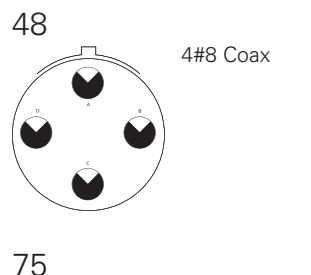
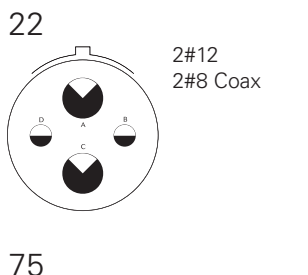
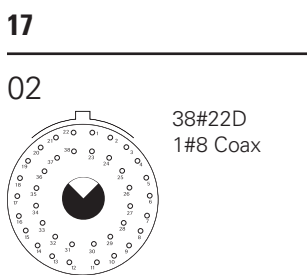
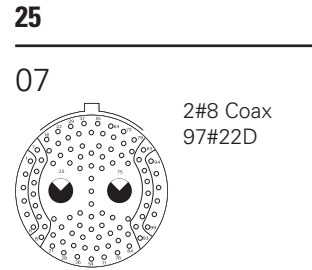
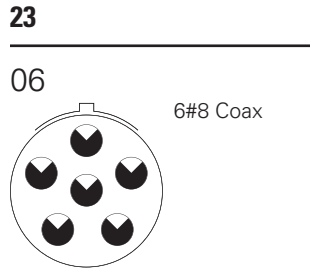
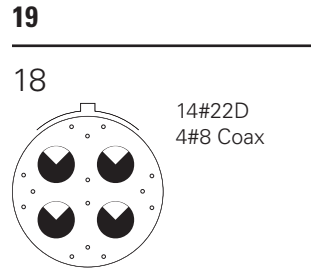
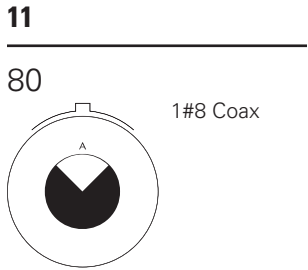

Ordering information

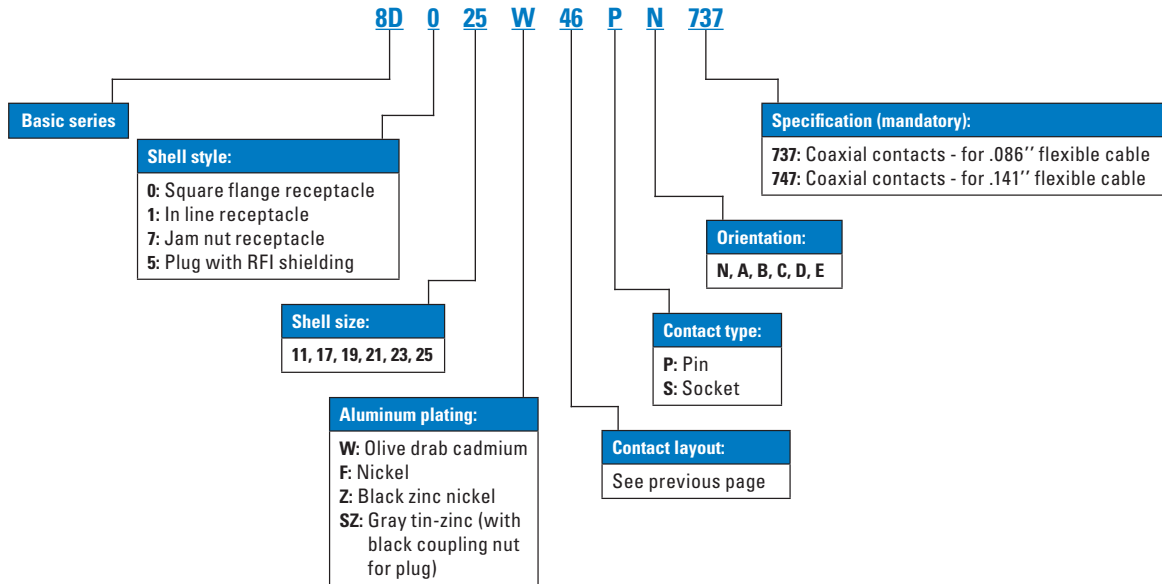

For other material and configuration (integrated clinch nuts, double flange, other cables etc.) please consult us.

Recommended cables

Designation	Part number	Description	
.086" flexible cable	Multiflex 86	Outer conductor contact	Soldered
.141" flexible cable	Multiflex 141	Outer conductor contact	Soldered

For other cables please consult us.

Souriau 8D series BMA coaxial contacts

Assembly instructions

Assembly instruction

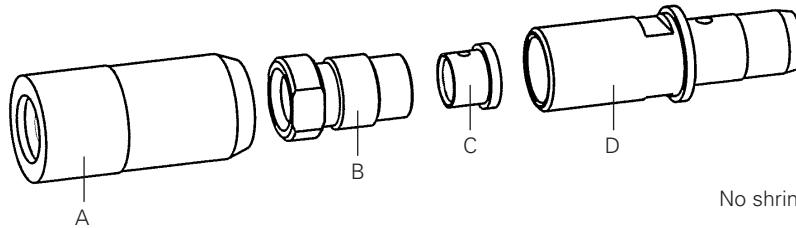

No shrinking sleeve allowed.

Picture	Process	Feature / check	Tools required
	<p>Dip the cut length of cable in flux and tin.</p> <p>Cut the jacket to the braid. Remove jacket.</p>	<p>The solder must flow at rear for min. 7 mm.</p>	<p>Stanley blade</p>
	<p>Remove cable dielectric and tinned braid according to diagram.</p>	<p>Do not damage inner conductor, dielectric and braid of cable.</p>	<p>Stanley blade Tip trimmer</p>
	<p>Form tip of center contact to a 90° cone.</p> <p>Slide Taper sleeve A and nipple B over cable.</p>	<p>Slide ferrule C over cable, flush to dielectric.</p>	<p>Stanley blade Tip trimmer</p>
	<p>Solder at X.</p> <p>Avoid excessive heat, immediately cool down and clean with alcohol.</p>	<p>If the cable does not fit into the cable entry, use a flat-nose plier to calibrate the braid.</p> <p>Center conductor of cable must be exactly centered.</p>	<p>Soldering iron Solder Flat-nose pliers</p>
	<p>Push prepared cable into connector body D and tighten nipple B.</p> <p>Taper sleeve A will be used for MIL-connector.</p>	<p>Torque: 3 Nm.</p>	<p>Male contact: Torque wrench AF.6 (3 Nm) Spanner AF.5.5</p> <p>Female contact: Torque wrench AF.6 (3 Nm) Spanner AF.6</p>

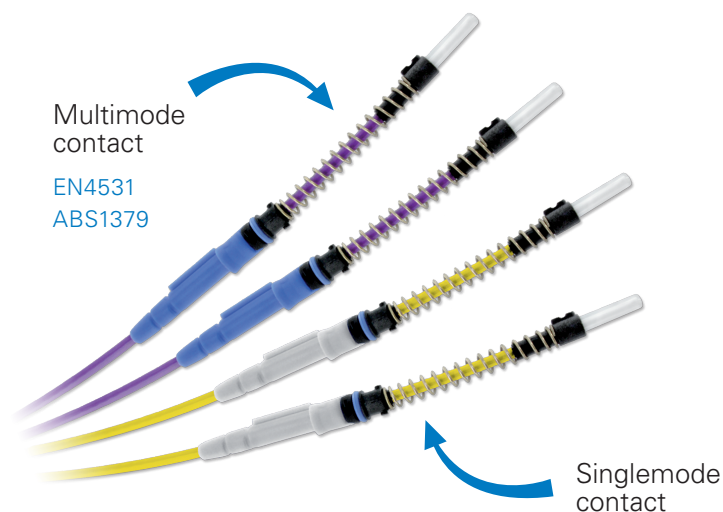

Description

ELIO contact multimode and singlemode:

- Robust 2.5mm ferrule
- Quick bayonet locking system, no tool needed
- Boot seal for sealing and bending restriction
- Compatible with tight and loose structure cable

Mechanical

Endurance

Minimum 500 mating/unmating operations

Shock

300 g, 3 ms as per EN 2591-6402 method A

Vibration

In MIL-DTL-38999 Series III/EN3645 connectors:

- Sine 5Hz to 3000Hz as per EN2591-6403 method A
- Random as per EN2591-6403 method B

Cable cyclic flexing

100 cycles, load 40N as per EN2591-609

Cable pulling

111N

Cable torsion

100 cycles, load 40N as per EN2591-611

Environmental

Salt spray

See the connector standard

Temperature range

- 65°C to +125°C (1000 hours)

Rapid temperature change

10 cycles - 65°C / +150°C (30min/30min)

Air leakage

Max leakage 16 cm³/h, 2 hours, 40kPa differential pressure

Damp heat and low temperature

5 cycles of 48h -65°C/+70°C with stage at 40°C with 95% of humidity as per EN2591- 6303 method A

Optical

Multimode contact - Insertion loss (IL)

0.1dB typical
< 0.3dB over 95% of the samples as per EN2591-601,
< 0.7dB maximum on 100% of the samples after tests

Multimode contact - Return loss (RL)

> 21dB before and after tests as per EN2591-605

Singlemode contact - Insertion loss (IL)

0.3dB typical
< 0.5dB over 95% of the samples as per EN2591-601,
< 0.9dB maximum on 100% of the samples after tests

Singlemode contact - Return loss (RL)

> 55dB typical and > 50dB minimum

Resistance to fluids as per

MIL-DTL-38999/EN3645 standard

Fuel

JP5

Mineral Hydraulic fluid

MIL-PRF-5606 (NATO H-515)

Synthetic hydraulic fluid

AS1241 (Skydrol 500B4, LD4)

Mineral lubricant

MIL-PRF-7870 (NATO O-142)

Synthetic lubricant

MIL-PRF-23699 (NATO O-156),
MIL-PRF-7808 (NATO O-148)

Cleaning fluid

MIL-PRF-87937 diluted,
Propanol, white spirit,
Azeotrope R113 + methanol

De-icing fluid

AMS 1424 (NATO S-742)

Extinguishing fluid

Chlorobromomethane

Cooling fluid

Coolanol

Souriau 8D series ELIO fiber optic contact

Part numbers

ELIO contact - ordering information

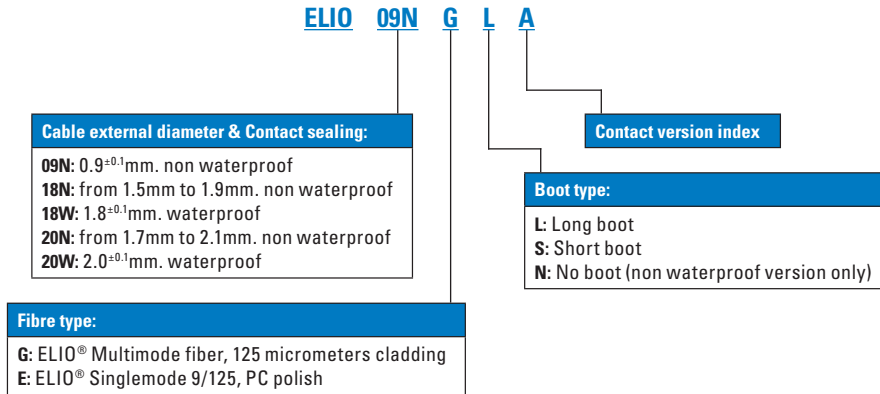

Note: For ABS1379/EN4531 cross reference, please consult us.

ELIO contact dimensions

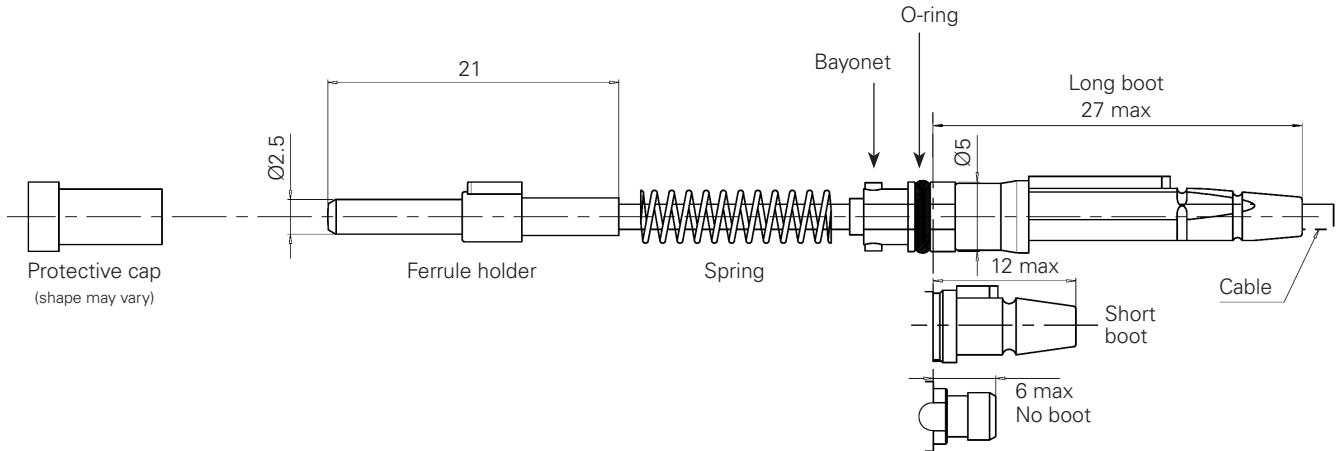

Recommended cables

We offer a wide range of cables in its assemblies, from low cost to high performance aeronautical cables. ELIO contact is compatible with singlemode and multimode cable, with tactical and breakout cable. ELIO contact is suitable with loose and tight structure cable.



EN4531

ABS1213

Description

MIL-DTL-38999 Series III/EN3645 with ELIO/ELIObeam contacts high density insert:

- Standard shells without shielding ring, available in aluminum, composite, stainless steel or bronze
- Performance complies with EN4531, based on MIL-DTL-38999/EN3645 specifications
- Temperature range: - 65°C to +125°C (cable limitation)

Contact layouts

09

01

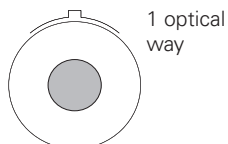

11

02

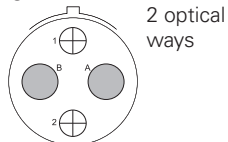

13

04

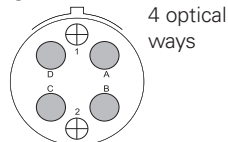

15

06

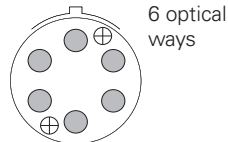

19

08

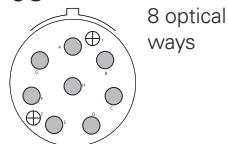

21

12

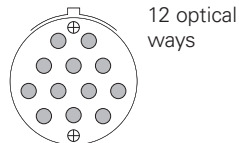

25

24

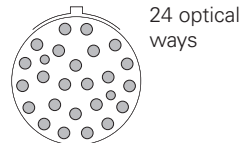

Note: Layouts 15-06 limited availability, please consult us.

Souriau 8D series ELIO fiber optic contacts

Technical specifications

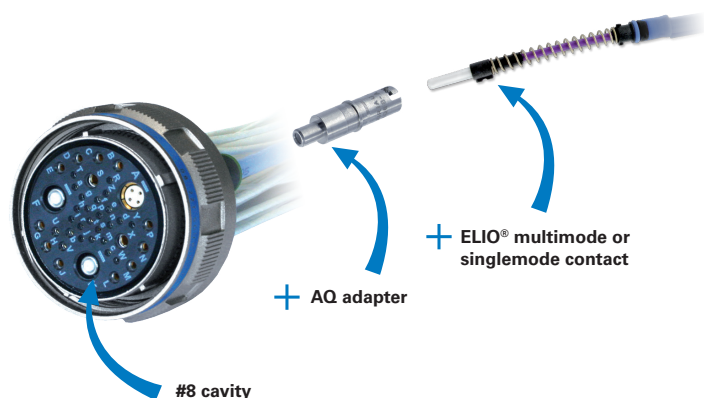

Description





MIL-DTL-38999 Series III/EN3645 with #8 Quadrax cavity adapter for ELIO/ELIObeam contacts:

- ELIO AQ is an adapter to enable the ELIO and ELIObeam contact to fit in any #8 cavities
- Multiple possibilities to mix optical and electrical signals in the same insert
- Compatible with standard MIL-DTL-38999 Series III/EN3645 connectors (aluminum, composite, stainless steel, bronze)
- Design ensures ELIO and ELIObeam optical performance
- Environmental performance per MIL-DTL-38999 and EN3645 standard
- Temperature range: - 65°C to +150°C (cable limitation)

Applications

Fiber optic connector for all military and aeronautical applications wherever severe vibration or mechanical resistance are required.

AQ Adapter for #8 Quadrax cavity

Insert type	Part number multimode	Part number singlemode
Male insert	 ELIOAQ6PB	 ELIOAQ6PB
Female insert	 ELIOAQ6SB	 ELIOAQ6SB674

Delivered with alignment boot.

Dimensions

See **Pages 87 and 88**.

Contact layouts

11

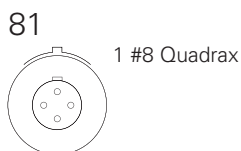

17

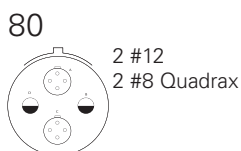

81



82

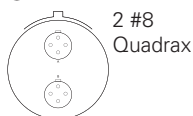

19



21



21



25



81

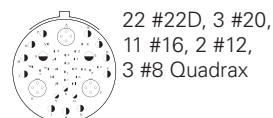

82

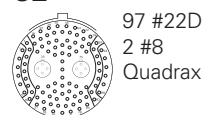

86

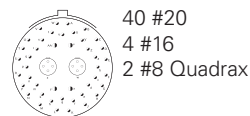

87

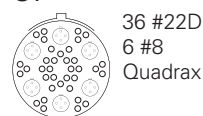

88

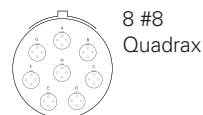

Dimensions

Plug and receptacles - mated / unmated

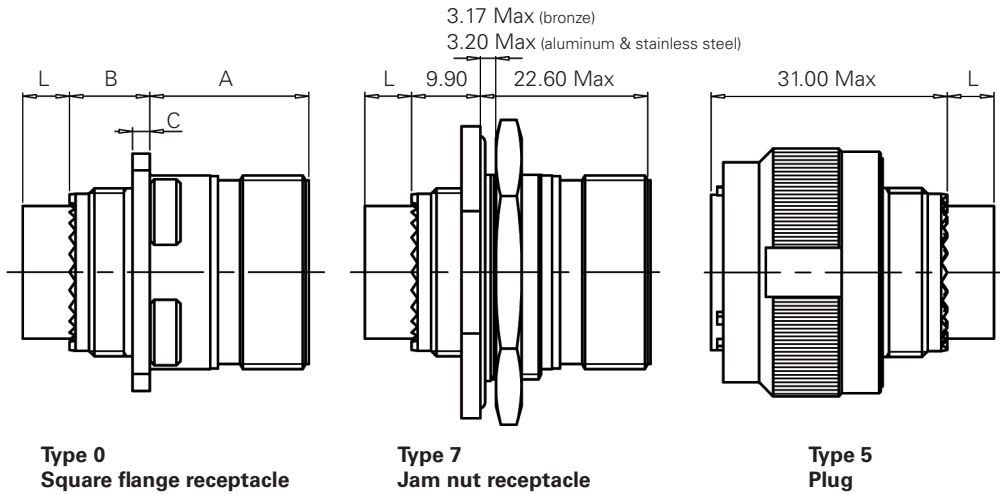

	A		B		C		L	
	Shell size 09 to 19	Shell size 25	Shell size 09 to 19	Shell size 25	Shell size 09 to 19	Shell size 25	Male insulator	Female insulator
Receptacle Type 0 & 7 Metal	20.90 Max	20.10 Max	12.50 Max	13.00 Max	2.50 Max	3.20 Max	4 Max	6.60 Max
Receptacle Type 0 Composite	20.90 Max	20.10 Max	12.50 Max	13.00 Max	3.65 Max	4.35 Max		

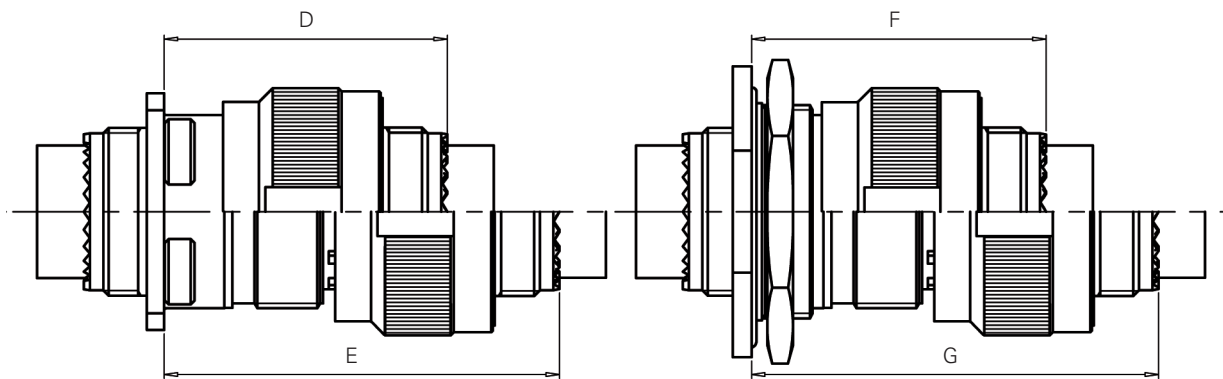

	D		E		F		G	
	Shell size 09 to 19	Shell size 25	Shell size 09 to 19	Shell size 25	Shell size 09 to 11	Shell size 13 to 25	Shell size 09 to 11	Shell size 13 to 25
Plug + Receptacle Type 0 & 7 Metal	37.00 Max	36.50 Max	52.30 Max	51.50 Max	39.00 Max	39.00 Max	54.00 Max	54.00 Max
Plug + Receptacle Type 0 Composite	37.00 Max	36.50 Max	52.30 Max	51.50 Max	N/A	N/A	N/A	N/A

Note: All dimensions are in millimeters (mm).

Souriau 8D series ELIO fiber optic contacts

Dimensions

Lengths - connectors with contacts

38999 Series III/EN3645 with ELIO contacts in ELIO high-density insert

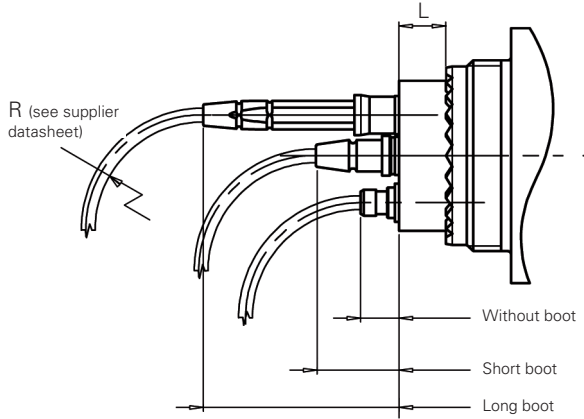

38999 Series III/EN3645 with ELIO contacts in ELIO AQ adapters

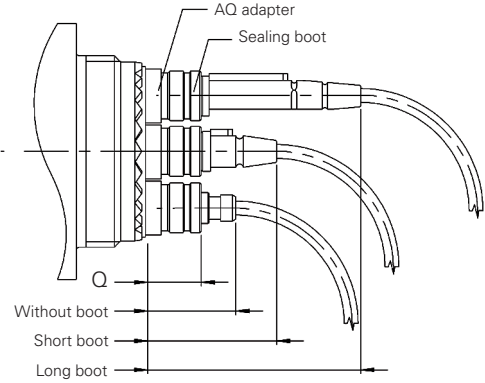

	ELIO high density insert					ELIO AQ adapters							
	Contact length					Contact length							
	L		Contact length			Q		Long boot		Short boot		Without boot	
	Male insulator	Female insulator	Without boot	Short boot	Long boot	Male insulator	Female insulator	Male insulator	Female insulator	Male insulator	Female insulator	Male insulator	Female insulator
Plug	4 Max	6.60 Max	6 Max	12 Max	27 Max	12 Max	9.5 Max	34.5 Max	32 Max	19.5 Max	17 Max	12.5 Max	10 Max
Square flange receptacle	4 Max	6.60 Max	6 Max	12 Max	27 Max	12.5 Max	10 Max	35 Max	32.5 Max	20 Max	17.5 Max	13 Max	10.5 Max
Jam nut receptacle	4 Max	6.60 Max	6 Max	12 Max	27 Max	12 Max	9.5 Max	34.5 Max	32 Max	19.5 Max	17 Max	12.5 Max	10 Max

Total length example

Square flange receptacle + plug + ELIO contacts in ELIO high-density insert

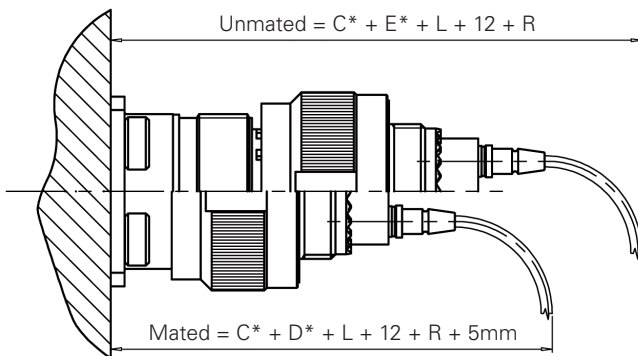

* See previous page

Note: All dimensions are in millimeters (mm).



EN4531 style
ABS1379 style

Description

ELIObeam contact:

- Fits in all ELIO standard cavities (ABS1213, EN4531)
- Optical lens for expanded beam
- Allows signal communication without physical contacts
- Used like ELIO standard contact

Mechanical

Endurance

Minimum 500 mating/unmating operations

Shock

300 g, 3ms as per EN 2591-6402 method A

Vibration

In MIL-DTL-38999 Series III/EN3645 connectors:

- Sine 5Hz to 3000Hz as per EN2591-6403 method A
- Random as per EN2591-6403 method B

Cable cyclic flexing*

100 cycles, load 40N as per EN2591-609

Cable pulling*

111N

Cable torsion*

100 cycles, load 40N as per EN2591-611

Environmental

Salt spray

See the connector standard

Temperature range*

- 65°C to +125°C (1000 hours)

Rapid temperature change

10 cycles - 65°C / +150°C (30min/30min)

Air leakage

Max leakage 16 cm³/h, 2 hours, 40kPa differential pressure

Damp heat and low temperature

5 cycles of 48h -65°C/+70°C with stage at 40°C with 95% of humidity as per EN2591- 6303 method A

Optical

Multimode contact - Insertion loss (IL)

< 0.7dB mean 95% of the samples as per EN2591-601, < 1.0dB maximum on 100% of the samples after tests

Multimode contact - Return loss (RL):

> 16dB before and after tests as per EN2591-605

Resistance to fluids as per MIL-DTL-38999/EN3645 standard

Fuel

JP5

Mineral hydraulic fluid

MIL-PRF-5606 (NATO H-515)

Synthetic hydraulic fluid

AS1241 (Skydrol 500B4, LD4)

Mineral lubricant

MIL-PRF-7870 (NATO O-142)

Synthetic lubricant

MIL-PRF-23699 (NATO O-156), MIL-PRF-7808 (NATO O-148)

Cleaning fluid

MIL-PRF-87937 diluted, Propanol, white spirit, Azeotrope R113 + methanol

De-icing fluid

AMS 1424 (NATO S-742)

Extinguishing fluid

Chlorobromomethane

Cooling fluid

Coolanol

* With multimode EN4641-100 and EN4641-301 cables and following the maintenance procedure in the document

Souriau 8D series ELIObeam fiber optic contact

Part numbers

Principle of expanded beam

The expanded beam concept expands and collimates the beam from the launch fiber. Without mechanical contact of the optical elements, the beam remains collimated until it is focused down to the receiving fiber.

The beam expansion at the interface provides protection of the fiber from contaminants.

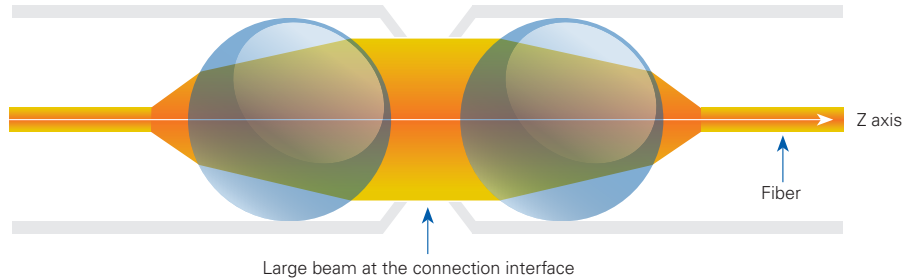

ELIObeam contact - ordering information

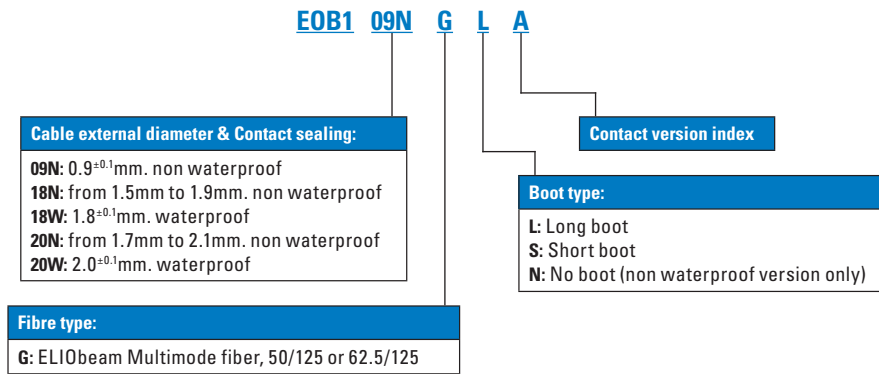

ELIObeam contact dimensions

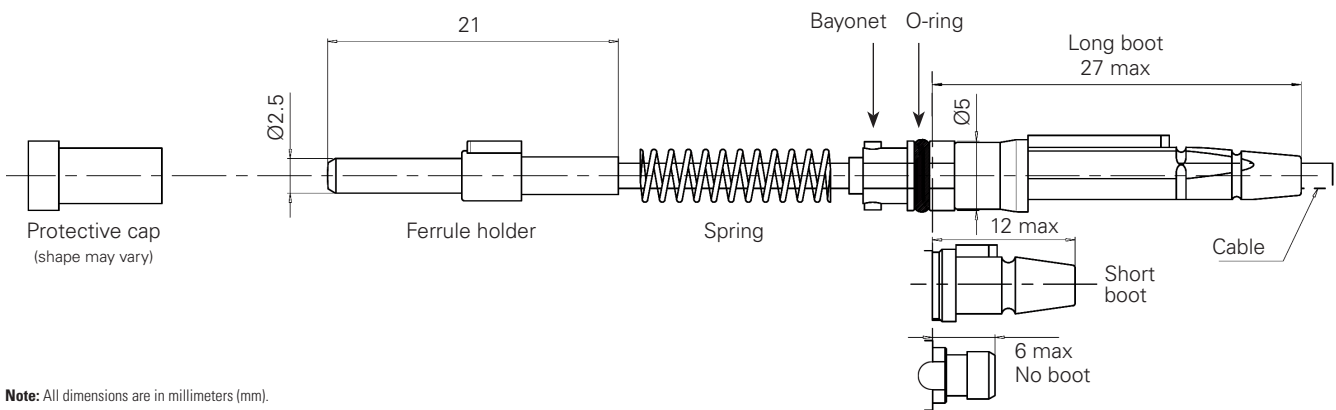

Note: All dimensions are in millimeters (mm).

Recommended cables

We offer a wide range of cables in its assemblies, from low cost to high performance aeronautical cables. ELIObeam contact is compatible with singlemode and multimode cables, with tactical and breakout cables. ELIObeam contact is suitable with loose and tight structure cable.

Optical patchcord ordering information

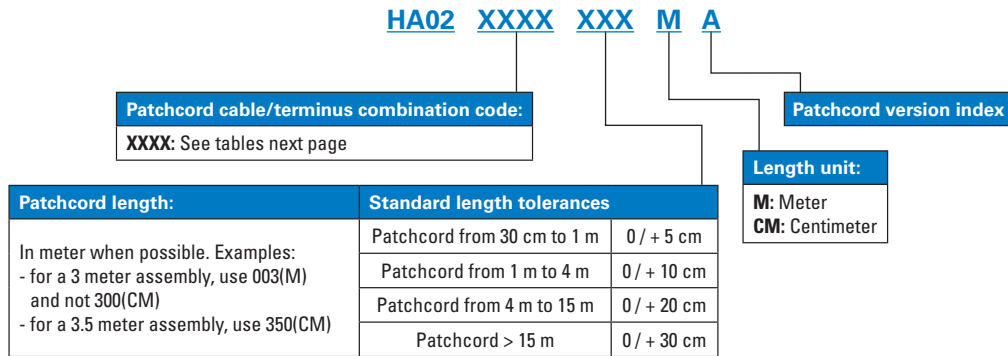
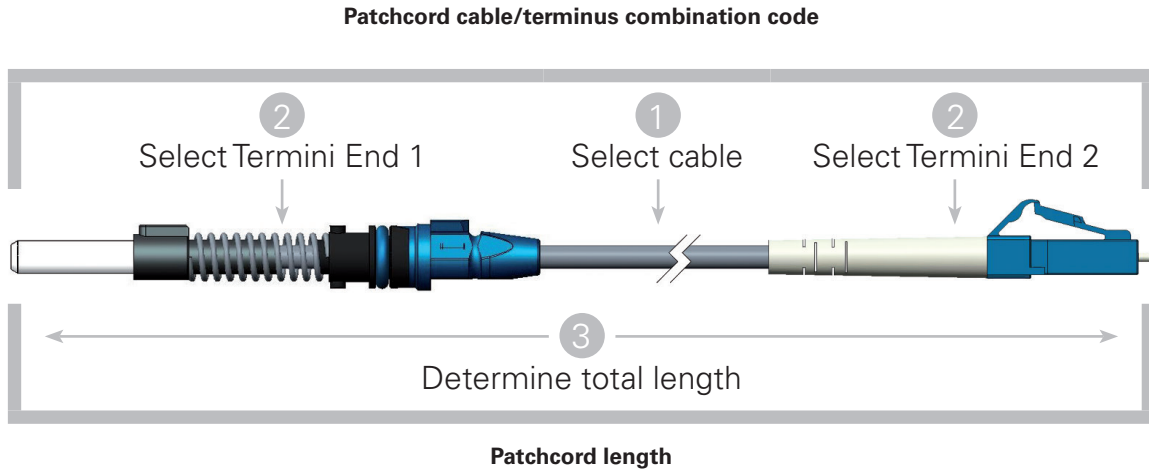

Note: To create your patchcord part number, select your patchcord combination code in tables next pages (1st contact - 2nd contact - fiber optic cable) and the length of your assembly on 3 digits in meter (M) or centimeter (CM). You must use meter when possible (see examples above).

Souriau 8D series ELIObeam fiber optic contact

Part numbers

1. Select cable

We offer a wide range of cables, from cost efficient to high performance aeronautical cables. Select your optical fiber's properties. Temperature range can be critical for your applications.

Application	Fiber type	Cable diameter	Temperature range	Tensile strength (N)	OM class	Attenuation (dB.km-1)*	Min. bend radius (mm)	Weight (kg.km-1)	Structure outer jacket	Standard	Cable type
For flying use high performance cables	62.5/125	1.8	-55°C to +125°C	250	OM2	4.0/2.0	20	4	Tight	ABS0963-003LF, EN4641-102	FCABLE11
	62.5/125	0.9	-55°C to +125°C	20	OM2	4.0/2.0	10	1	NA	EN4641-101	FCABLE41
	50/125	1.8	-65°C to +135°C	200	OM3	4.0/2.0	5	4	Tight	EN4641-301	FCABLE22
For harsh environment cost efficient cables	50/125	1.8	-40°C to +85°C	130	OM3	3.0/1.0	25	2.2	Loose	-	FCABLE42
	62.5/125	1.8	-40°C to +85°C	130	OM1	3.5/1.5	25	2.2	Loose	-	FCABLE61

* 1st value @850nm for multimode cable, 2nd value @1300nm for multimode (respectively 1300nm and 1550nm for singlemode)
Consult us for other harsh environment cables.

2 . Select termini end 1 & 2 according to your selected cable, and get your final patchcord cable/terminus combination code

Most common cables with most common contacts - For other combinations please contact us.
All contacts are UPC polished otherwise specified.

	EOB118WGLA	EOB118WGLA	EOB118WGLA	EOB118WGLA	EOB109NGLA
Termini End 1	Cable types	Cable types	Cable types	Cable types	Cable type
Termini End 2	FCABLE11	FCABLE22	FCABLE42	FCABLE61	FCABLE41
ELIO18NGLA	3060	3071	3091	3102	N/A
ELIO18NGNA	3061	3072	3092	3103	N/A
ELIO18NGSA	3062	3073	3093	3104	N/A
ELIO18WGLA	3063	3074	3094	3105	N/A
ELIO18WGSA	3064	3075	3095	3106	N/A
LC Simplex	3065	3076	3097	3108	3086
ARC1G18TA	3066	3077	N/A	N/A	N/A
ARC1G18LA	N/A	N/A	3098	3109	N/A
ARC1G09TA	N/A	N/A	N/A	N/A	3087
FC/PC	3067	3078	3096	3107	3085
SC	3068	3079	3099	3110	3088
ST	3069	N/A	3100	3111	3089
ST2	N/A	3080	N/A	N/A	N/A
EOB118WGLA	3070	3081	3101	3112	N/A
ELIO09NGLA	N/A	N/A	N/A	N/A	3082
ELIO09NGNA	N/A	N/A	N/A	N/A	3083
ELIO09NGSA	N/A	N/A	N/A	N/A	3084
EOB109NGLA	N/A	N/A	N/A	N/A	3090



Description

Power contacts:

- Quick screw coupling connector with removable crimp contact
- Shells are available in aluminum, composite, stainless steel, titanium and bronze
- Six layouts with different current rating
- Power hermetic and high power are also available

Mechanical

Shell

Aluminum alloy, composite, bronze, stainless steel, titanium

Plating

- Olive green cadmium (W/J)
- Nickel (F/M/TF/S)
- Without plating (X for composite, TT for titanium and JVS for bronze)
- Passivated (K)
- Gray tin-zinc (with black coupling nut for plug) (SZ)
- Black zinc nickel (Z)

Grommet and seal

Silicon elastomer

Insulator

Thermoset

Contact body

Copper alloy

Contact retention

- #4: 200N
- #8: 111N

Shock

300g during 3ms

Endurance

500 mating / unmating operations

Vibration

MIL DTL 38999

Do not mate/unmate when power is on

Electrical

Dielectric withstanding

Test voltage rating (Vrms)

Service	Sea level	at 21 000 m
M	1 300	800
I	1 800	1 000

Insulation resistance

5000 M Ω under 500 Vdc

Max current rating per contact

- #4 = 80A
- #8 = 45A

Contact resistance

- #4 = 2m Ω
- #8 = 3m Ω

Shielding

MIL DTL 38999

Shell continuity

- W, Z & SZ: 2.5 m Ω
- F: 1m Ω
- J, M: 3 m Ω
- JVS: 5 m Ω

Not compliant UL/VDE

Environmental

Temperature range

- W, Z, SZ, J, X, JVS: - 65°C +175°C
- F, M, K, S, TT, TF: - 65°C +200°C

Sealing

MIL DTL 38999

Damp heat

MIL DTL 38999

Salt spray

- W, TT, TF, K, JVS: 500 hours
- F, S = 48 hours
- J, M, X: 2000 hours

Fire resistance

EN 2591 - C 17 method A

Resistance to fluid

MIL DTL 38999

Souriau 8D series power contacts

Part numbers

Connector part numbers

Aluminum, composite, stainless steel & titanium connector

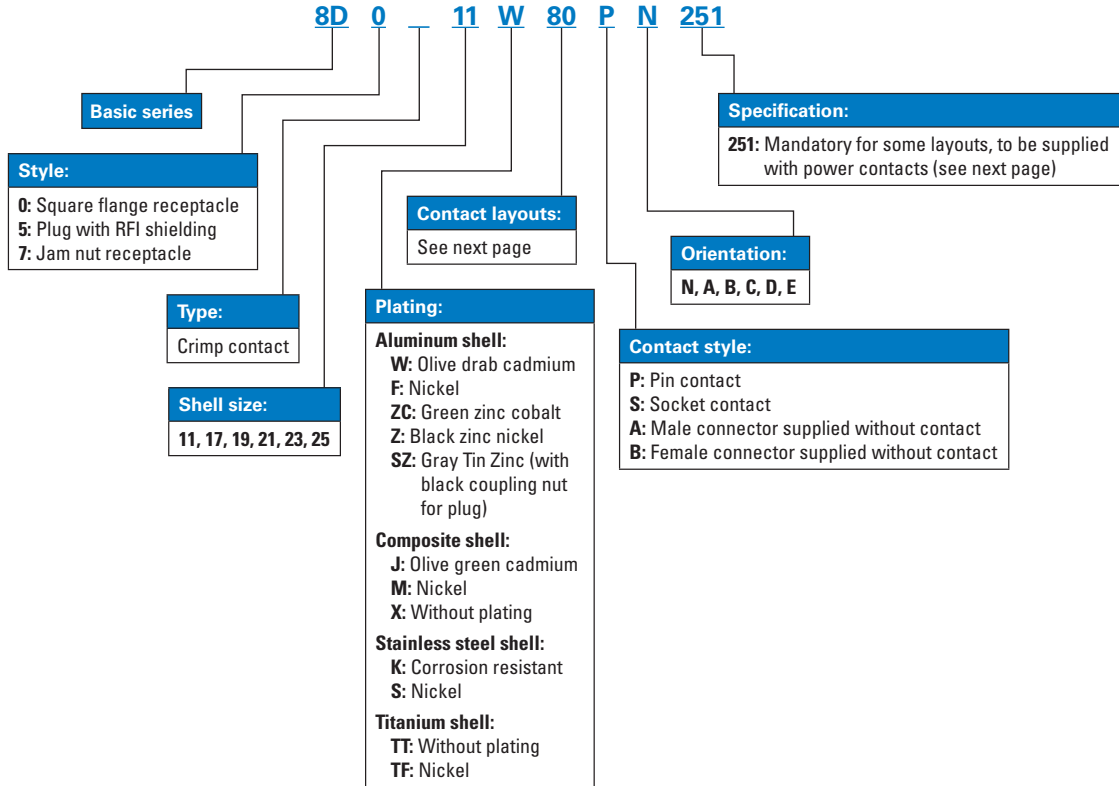

Bronze connector

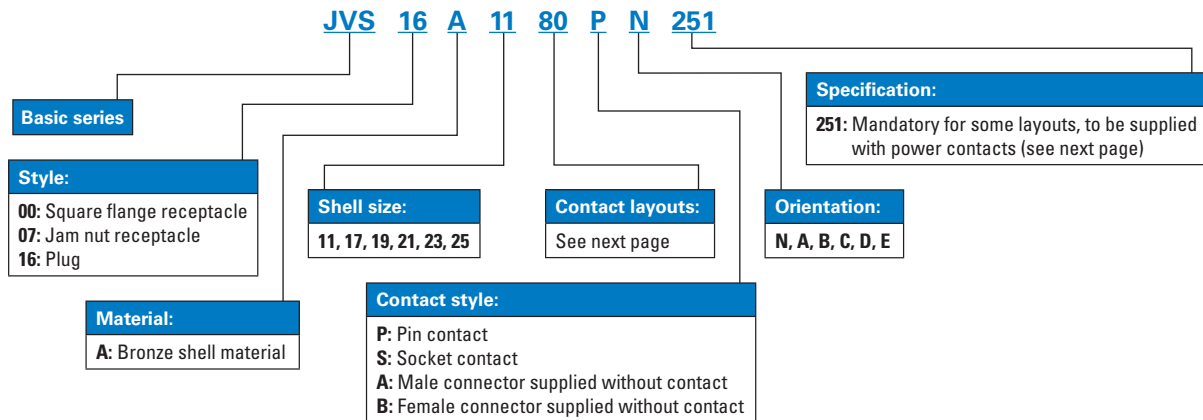

Contact layouts

 Contact #22D
  Contact #20
  Contact #16
  Contact #12
  Contact #8 coax
  Contact #4 power

11

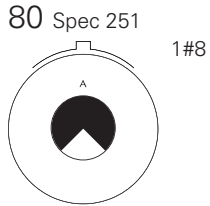

17

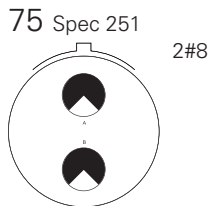
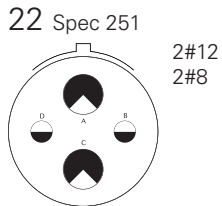
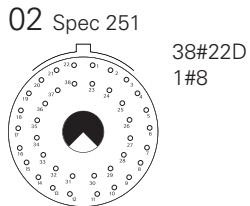

19

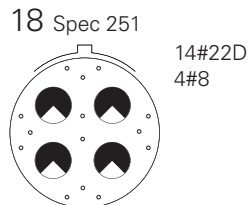

21

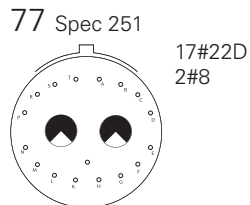
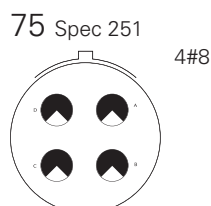
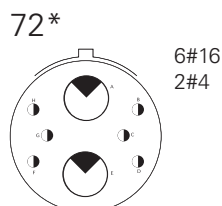
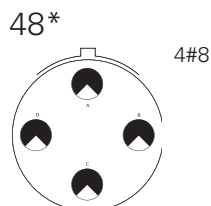
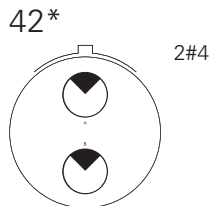
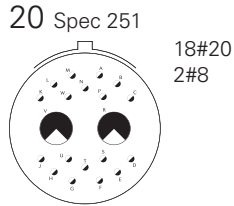

23

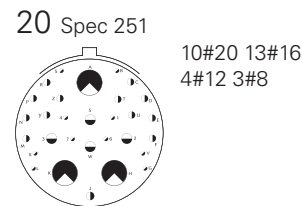
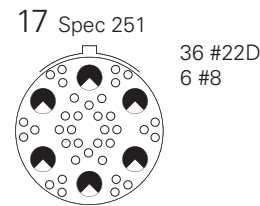
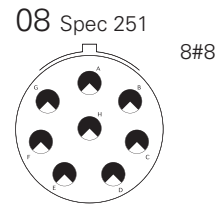
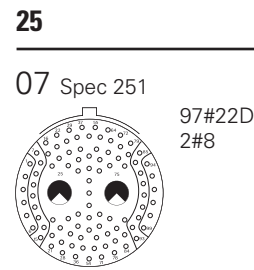
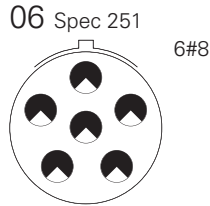

25

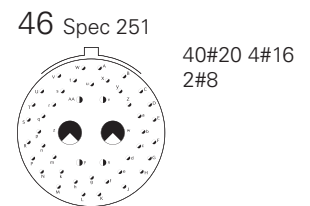
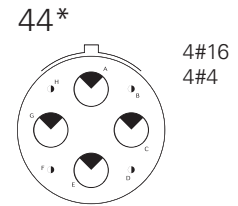
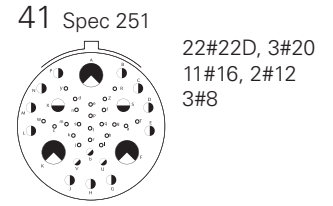

* Power contacts on standard, no spec. 251 needed.

Souriau 8D series power contacts

Contacts

Power contacts

Contact size	Contact type	Part number	Reducer	Cable size max.		Boot
				AWG	mm ²	
#4	Male	85997598900*	Without	N/A	25 mm ²	N/A not sealed
	Female	85997599900*	Without	N/A	25 mm ²	N/A not sealed
	Male	85997534	Without	AWG 4	16 to 21 mm ²	85994594 for cable 16mm ²
	Female	85997535	Without	AWG 4	16 to 21 mm ²	85994594 for cable 16mm ²
	Male	85997524	Without	AWG8	9 mm ²	N/A not sealed
	Female	85997525	Without	AWG8	9 mm ²	N/A not sealed
	Male	85997534	84002352A	AWG6	10 mm ²	85994593
	Female	85997535	84002352A	AWG6	10 mm ²	85994593
	Male	85997528900	Without	AWG6	10 mm ²	85994593
	Female	85997529900	Without	AWG6	10 mm ²	85994593
#8	Male	85997580	Without	AWG8	9 mm ²	85994542
	Female	85997581	Without	AWG8	9 mm ²	85994542
	Male	85997580	85997645	AWG10	6 mm ²	85994547
	Female	85997581	85997645	AWG10	6 mm ²	85994547
#8 according to EN 3155	Male	85996215900	Without	AWG8	9 mm ²	85994542
	Female	85996217900	Without	AWG8	9 mm ²	85994542
	Male	85996216900	Without	AWG10	6 mm ²	85994547
	Female	85996218900	Without	AWG10	6 mm ²	85994547
#8 JVS only	Male	85997544	Without	AWG8	9 mm ²	85994542
	Female	85997541	Without	AWG8	9 mm ²	85994542
	Male	85997544	85997645	AWG10	6 mm ²	85994547
	Female	85997541	85997645	AWG10	6 mm ²	85994547

Cable section AWG	#22	#20	#16	#12	#10	#8	#4
mm ² maxi	0.34	0.6	1.34	3.18	5.8	9	21
mm ² mini	0.095	0.21	0.6	1.91	3.8	5.8	16

* Not included in connector P/N.
Must be ordered separately.

Bus bar contact

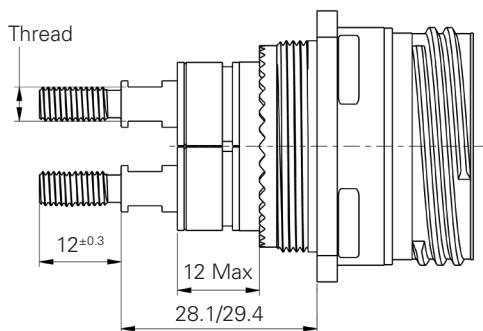

Contact size	Thread	Part number		Boots	Lug Ø
		Male	Female		
#4	M5x0.8	85930873A900	85930875A900	85994594	5.2
#8	M3x0.5	85930872A900	85930874A900	85994542	3.2

Contacts available separately only.
Lug: tin over copper recommended. Dimensions for indication only.

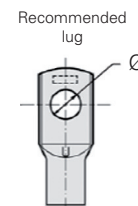

Power tools

Contact size	Contact type	Contact reference	Cable AWG	Crimping tool			Contact extraction tool (metallic)	Contact extraction tool (plastic)
				Automatic tool: M22520/23-01	Automatic tool: M22520/23-01	Manual hand tool: M300 BT		
				Die set	Locator	Locator		
#4	Male	8599-7534	#4-5 or #10-16mm ²	M22520/23-04	M22520/23-11	N/A	8533-8175	M81969/14-07
	Female	8599-7535	#4-5 or #10-16mm ²	M22520/23-04	M22520/23-11	N/A	8533-8175	M81969/14-07
#8 JVS only	Male	8599-7544	#8 or #10	M22520/23-02	8599-9601	SP 593	8660-197	M81969/14-12
	Female	8599-7541	#8 or #10	M22520/23-02	8599-9601	SP 593	8660-197	M81969/14-12
#8	Male	8599-7580	#8 or #10	M22520/23-02	8599-9601	SP 593	8660-197	M81969/14-12
	Female	8599-7581	#8 or #10	M22520/23-02	8599-9601	SP 593	8660-197	M81969/14-12

Automatic tool for contacts #4 and #8



Crimping tool
M22520/23-01

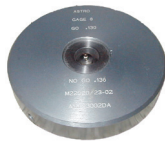

Die set



Locator

Manual hand tool for contacts #8



Crimping tool M300 BT



Locator

Extraction tool



Metallic tool

Souriau 8D series high power contacts

Technical specifications



Description

High power contacts:

- Threaded coupling connector with single power contact in an aluminum shell
- Three shell sizes:
 - Size 19: up to 450 A at 40°C
 - Size 23: up to 650 A at 40°C
 - Size 25: up to 850 A at 40°C
- Silver plated contact
- Pin contact is equipped with a plastic cap to prevent electrical shock
- The modular design includes:
 - Removable backshell: straight, right angle or threaded contact
 - Backshell termination: shrink boot

Mechanical

Shell

Aluminum alloy

Shell plating

Black zinc nickel (Z)
Cadmium olive drab (W)
Gray tin-zinc (with black coupling nut for plug) (SZ) - please consult us

Insulator

Thermoplastic

Grommet and interfacial seal

Silicone elastomer

Contact body

Copper alloy

Endurance

500 mating/unmating operations

Vibration

According to Def Stan 00-35
4.2 g rms vert - 6h/3 axes

Electrical

Test voltage

> 1500 V

Shell to shell continuity

(no backshell) < 2.5 mΩ

EMI

85 dB @ 1GHz (F)

Connector rating

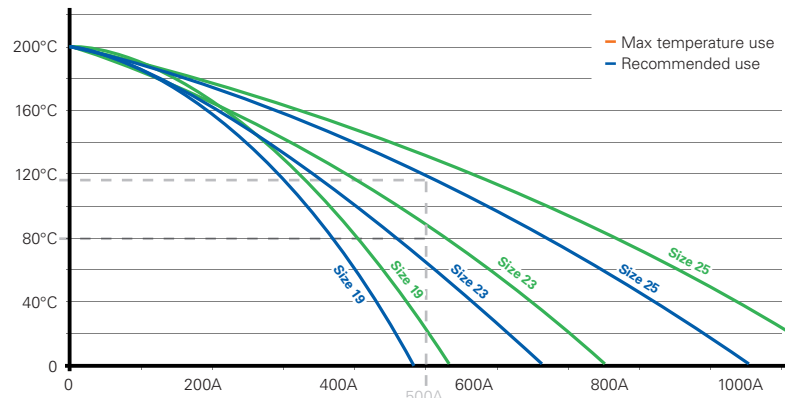

Example for 500A:

Shell size 25 with contact diameter 20: max temperature 135°C; recommended 120°C

Shell size 23 with contact diameter 18: max temperature 90°C; recommended 80 °C

Shell size 19 with contact diameter 14: not recommended

Wire must be compatible with current and temperature used for the connector.

Environmental

Temperature range

-65°C +175°C

Sealing

IP67 on mated connector
(1 meter/30 min)

Salt spray

500 hours

Creepage and clearance

Min length in mm according to IEC60664-1

Shell size	Creepage	Clearance
19	2.805	2.492
23	2.830	4.492
25	2.715	4.492

Resistance to fluids

According to MIL-DTL-38999 standard

- Gasoline: JP5 (OTAN F44)
- Mineral hydraulic fluid: MIL-H-5606
- (OTAN H515)
- Synthetic hydraulic fluid: Skydrol 500 B4

LD4 (SAE AS 1241)

- Mineral lubricating: MIL-L-7870A (OTAN 0142)
- Synthetic lubricating: MIL-L-23699 (OTAN 0156), MIL-L-7808
- Cleaning fluid: MIL-C-87936 diluted
- De-icing fluid: MIL-A-8243
- Extinguishing fluid: Bromochloromethane
- Cooling fluid: Coolanol

Contact layouts

19

H1

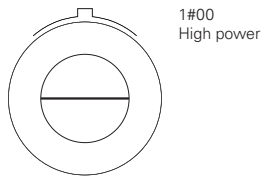

1#00
High power

23

H1

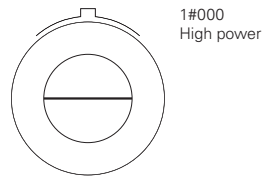

1#000
High power

25

H1

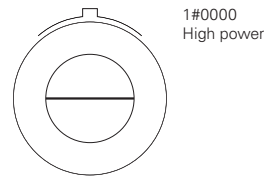

1#0000
High power

Other size: Please consult us.

Ordering information

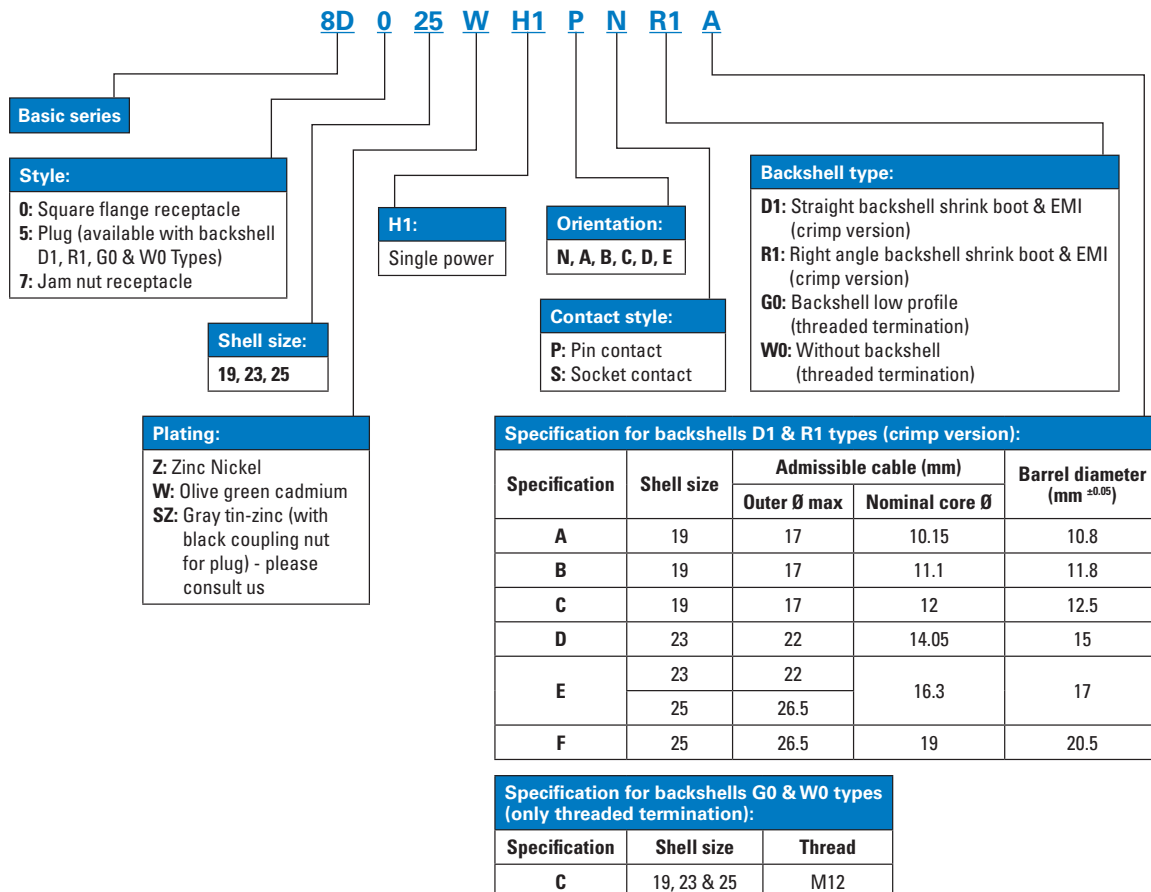

Other thread, please consult us.

Note: For other configuration, please consult us.

Souriau 8D series high power contacts

Backshells

Backshell type

Description

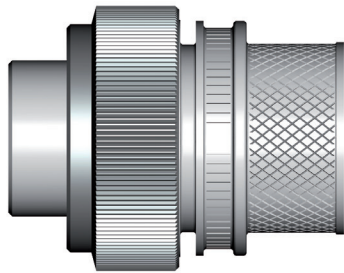

D1: Straight backshell shrink boot & EMI (crimp version)

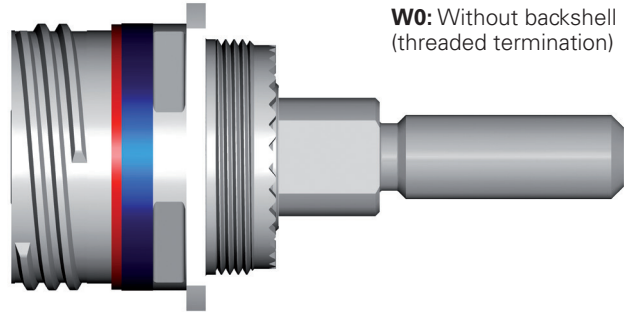

W0: Without backshell (threaded termination)

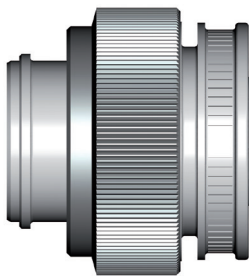

G0: Backshell low profile (threaded termination)

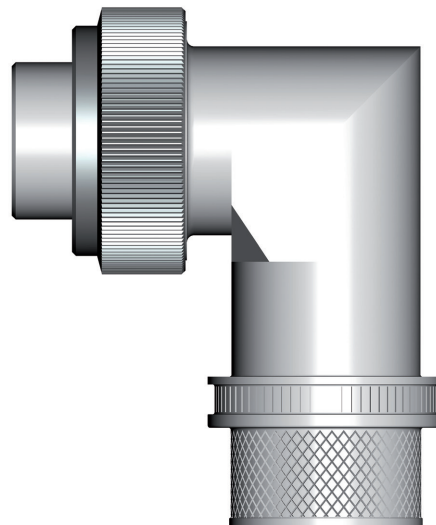

R1: Right angle backshell shrink boot & EMI (crimp version)

Dimensions

Plug and receptacles

8D0 Square flange receptacle

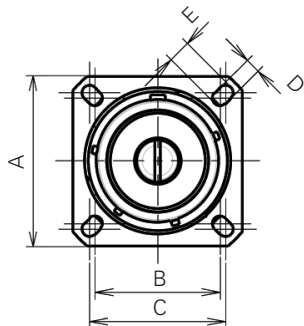

8D5 Plug

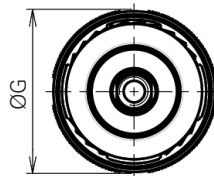

8D7 Jam nut receptacle

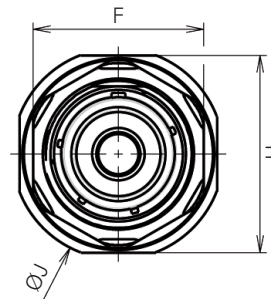

Shell size	A ^{±0.1}	B ^{±0.1}	C ^{±0.1}	D ^{±0.1}	E ^{±0.1}	F Max	ØG Max	H ^{±0.25}	ØJ ^{±0.25}
19	36.5	26.97	29.36	3.29	4.98	41	38.5	45.95	49.15
23	42.9	31.75	34.93	3.96	6.2	47	44.9	52.35	55.55
25	46	34.93	38.1	3.96	6.2	52	48	55.55	58.65

Note: All dimensions are in millimeters (mm).

Dimensions

Backshell D1 type

With 8D0
(square flange receptacle)

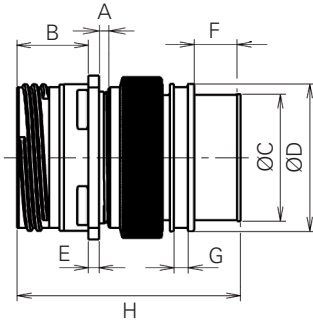

With 8D5
(plug)

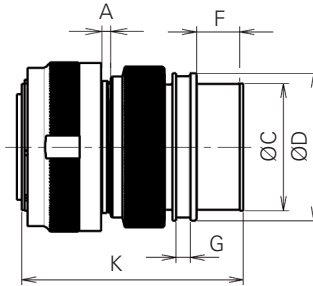

With 8D7
(jam nut receptacle)

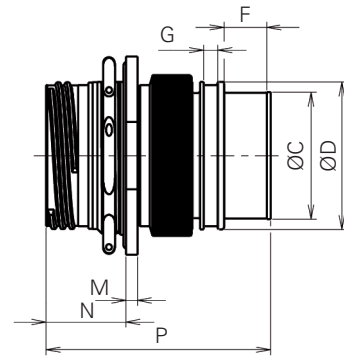

Shell size	A Max	B Max	ØC ^{+0.1}	ØD ^{+0.1}	E ^{+0.1}	F ^{+0.2}	G ^{+0.2}	H Max	K Max	M ^{+0.25}	N Max	P Max
19	2.65	20.9	25.6	31.6	2.26	12	4	62.5	62	3.25	22.8	63
23	2.65	20.1	32.4	38.6	2.97	12	4	62.5	62	3.25	22.8	63
25	2.65	20.1	35.6	42.1	2.97	12	4	62.5	62	3.25	22.8	63

Backshell R1 type

With 8D0
(square flange receptacle)

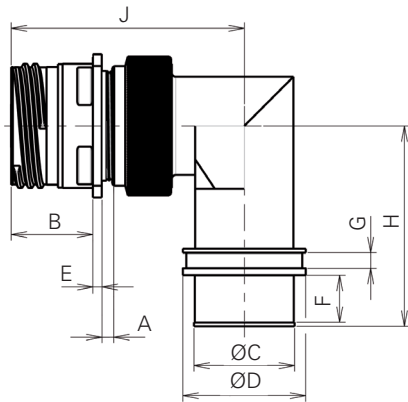

With 8D5
(plug)

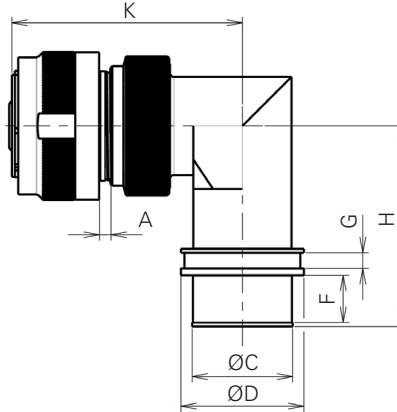

With 8D7
(jam nut receptacle)

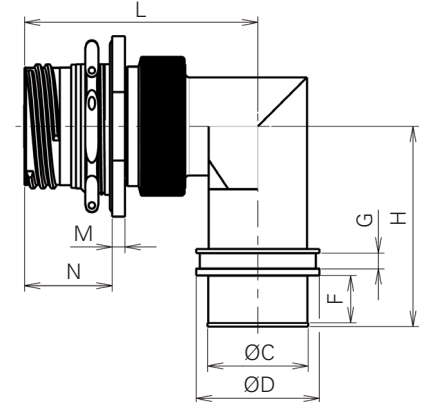

Shell size	A Max	B Max	ØC ^{+0.1}	ØD ^{+0.1}	E ^{+0.1}	F ^{+0.2}	G ^{+0.2}	H Max	J Max	K Max	L Max	M ^{+0.25}	N Max
19	2.85	20.9	25.6	31.3	2.26	12	4	51.1	59.8	59.3	59.8	3.25	22.8
23	2.85	20.1	32.4	38.1	2.97	12	4	54.4	63.2	62.7	63.2	3.25	22.8
25	2.85	20.1	35.6	41.3	2.97	12	4	56.1	64.8	64.3	64.8	3.25	22.8

Note: All dimensions are in millimeters (mm).

Souriau 8D series high power contacts

Backshells

Dimensions

Backshell G0 type

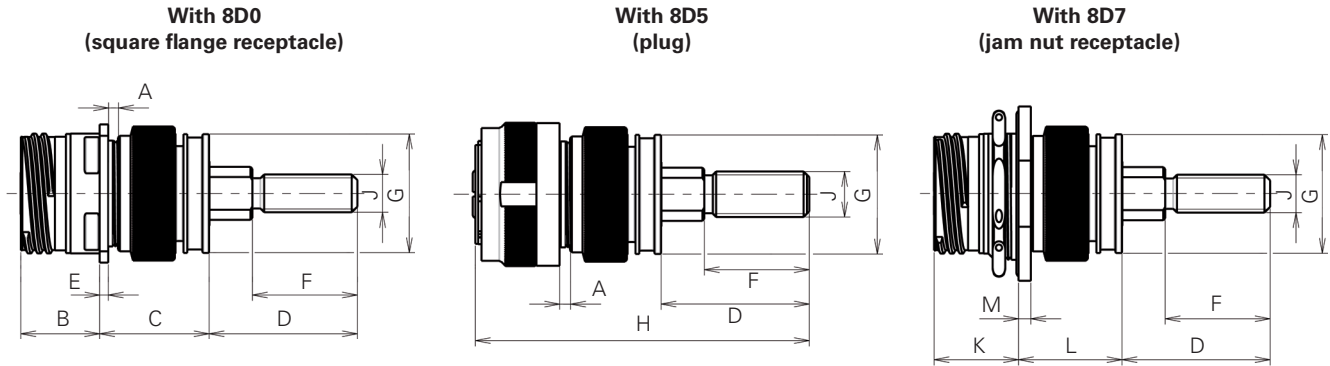

Shell size	A Max	B Max	C Max	D Max	E ^{±0.1}	F ^{±0.2}	ØG ^{±0.1}	H Max	J Max	K Max	L Max	M ^{±0.25}
19	2.65	20.9	29	39.4	2.26	25	31.3	88.1	M12 x 1.75	22.6	27.6	3.25
23	2.65	20.1	29.8	39.4	2.97	25	38.1	88.1	M12 x 1.75	22.6	28.4	3.25
25	2.65	20.1	29.8	39.4	2.97	25	41.3	88.1	M12 x 1.75	22.6	28.4	3.25

Backshell W0 type

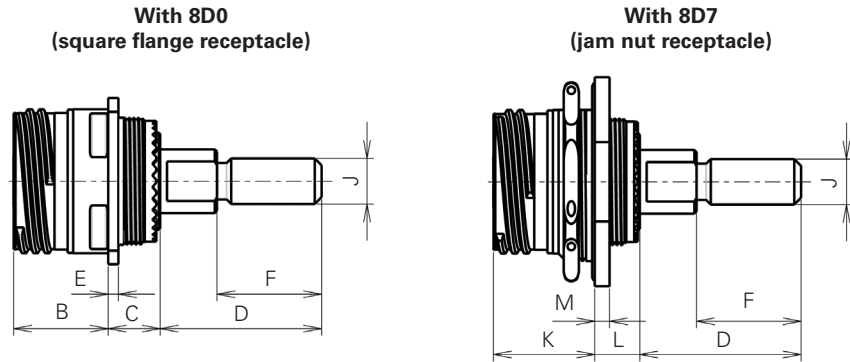

Shell size	B Max	C Max	D Max	E ^{±0.1}	F ^{±0.2}	J Max	K Max	L Max	M ^{±0.25}
19	20.9	14	40	2.26	25	M12 x 1.75	22.6	12	3.25
23	20.1	14	40	2.97	25	M12 x 1.75	22.6	12	3.25
25	20.1	14	40	2.97	25	M12 x 1.75	22.6	12	3.25

Note: All dimensions are in millimeters (mm).



Description

High density:

- Derived from MIL-DTL-38999 Series III standards
- 100% Scoop-proof
- Available in four shell sizes
- Contacts #26 for cable AWG 26 to 30 (24 to 30 under request)
- Double flange and clinch nut versions

Mechanical

Shell

- Aluminum, composite, stainless steel

Shell plating

- 8D Aluminum:
 - Cadmium olive drab (W)
 - Nickel (F)
 - Black zinc nickel (Z)
 - Gray tin-zinc (with black coupling nut for plug) (SZ)
- 8D Composite:
 - Cadmium olive drab (J)
 - Nickel (M)

Insulator

Thermoplastic

Seal

Liquid silicone rubber

Contact

Copper alloy

Contact plating

Gold

Endurance

500 mating/unmating operations

Shock & Vibration

According to 38999 specification

Electrical

Contact resistance

Size 26: 16 mΩ

Insulation resistance

≥5000MΩ (at 500Vdc)

Contact rating

Size 26: 3Amp

Shell continuity

- Aluminum shell
 - Cadmium olive drab (W): 2.5 mΩ
 - Nickel (F): 1 mΩ
 - Black zinc nickel (Z): 2.5 mΩ
 - Gray tin-zinc (with black coupling nut for plug) (SZ): 2.5 mΩ
- Composite shell
 - Cadmium olive drab (J): 3 mΩ
 - Nickel (M): 3 mΩ
- Stainless steel shell
 - Passivated (K): 10 mΩ
 - Nickel (S): 1 mΩ

Environmental

Temperature range

-55°C to +175°C
-55°C to +200°C (Nickel version)

Sealing mated connectors

IP 67 (1 meter for 30 min minimum)

Salt spray

- Aluminum shell:
 - W: 500 hrs
 - F: 48 hrs
 - Z: 500 hrs
 - SZ: 500 hrs
- Composite shell: 2000 hrs
- Stainless steel shell: 500 hrs

Resistance to fluids

According to MIL-DTL-38999 standard

- Gasoline: JP5 (OTAN F44)
- Mineral hydraulic fluid: MIL-H-5606 (OTAN H515)
- Synthetic hydraulic fluid: Skydrol 500 B4

LD4 (SAE AS 1241)

- Mineral lubricating: MIL-L-7870A (OTAN 0142)
- Synthetic lubricating: MIL-L-23699 (OTAN 0156), MIL-L-7808
- Cleaning fluid: MIL-C-87936 diluted
- De-icing fluid: MIL-A-8243
- Extinguishing fluid: Bromochloromethane
- Cooling fluid: Coolanol

Souriau 8D series high density

Contact layouts

Contact layouts

09

12

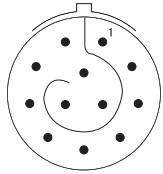

12#26

11

26

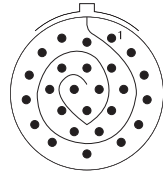

26#26

13

43

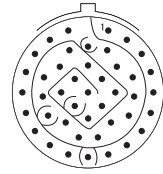

43#26

15

68

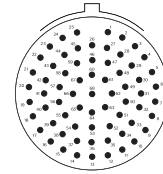

68#26

PCB hole drilling and position information. See **Pages 65 & 66**.

Ordering information

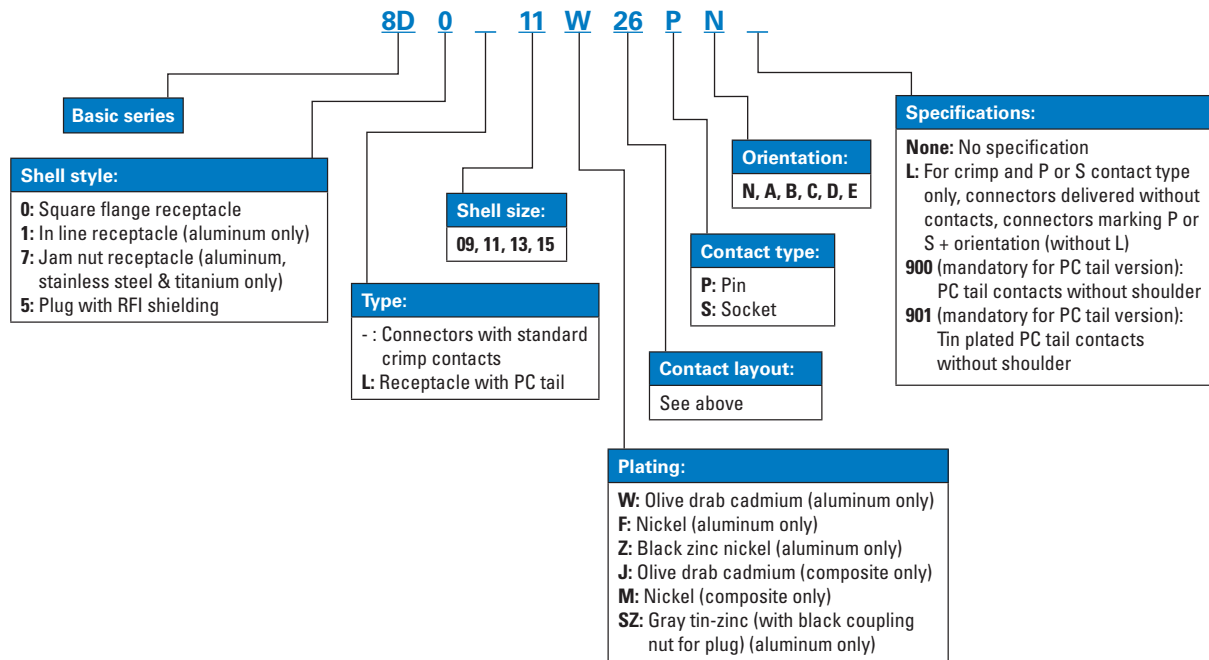

Recommended cable

Standard military cable as M22759 or EN2267 and derivative.



Description

Plug with integrated backshell:

- Derived from standard MIL-DTL-38999 Series III
- Plug in nine sizes (from size 09 to 25)
- Black zinc nickel, cadmium and nickel plating

Mechanical

Shell

Aluminum

Shell plating

- Nickel (F)
- Black zinc nickel (Z)
- Olive drab cadmium: (W)
- Gray tin-zinc (with black coupling nut for plug) (SZ) - please consult us

Insulator

Thermoplastic

Seal

Silicone elastomer

Contact

Copper alloy

Contact plating

Gold over nickel

Endurance

500 mating/unmating operations

Shock & Vibration

According to 38999 specification

Electrical

Contact resistance

Contacts size	22	20	16	12	8	4
Resistance mΩ	14.6	7.3	3.8	3.5	3	2

Insulation resistance

≥5000mΩ (at 500Vdc)

Contact rating

Contacts size	22	20	16	12	8	4
Rating (A)	5	7.5	13	23	45	80

Shell continuity

- Nickel (F): 1 mΩ
- Black zinc nickel (Z): 2.5 mΩ
- Olive drab cadmium (W): 2.5 mΩ

Environmental

Temperature range

- -55°C to +175°C (Z & W)
- -55°C to +200°C (F)

Sealing mated connectors

IP 67 (1 meter for 30 min minimum)

Salt spray

- 48 hours (F)
- 500 hours (Z & W)

Resistance to fluids

According to MIL-DTL-38999 standard

- Gasoline: JP5 (OTAN F44)
- Mineral hydraulic fluid: MIL-H-5606 (OTAN H515)
- Synthetic hydraulic fluid: Skydrol 500 B4

LD4 (SAE AS 1241)

- Mineral lubricating: MIL-L-7870A (OTAN 0142)
- Synthetic lubricating: MIL-L-23699 (OTAN 0156), MIL-L-7808
- Cleaning fluid: MIL-C-87936 diluted
- De-icing fluid: MIL-A-8243
- Extinguishing fluid: Bromochloromethane
- Cooling fluid: Coolanol

Souriau 8D series plug with integrated backshell

Part numbers

Ordering information

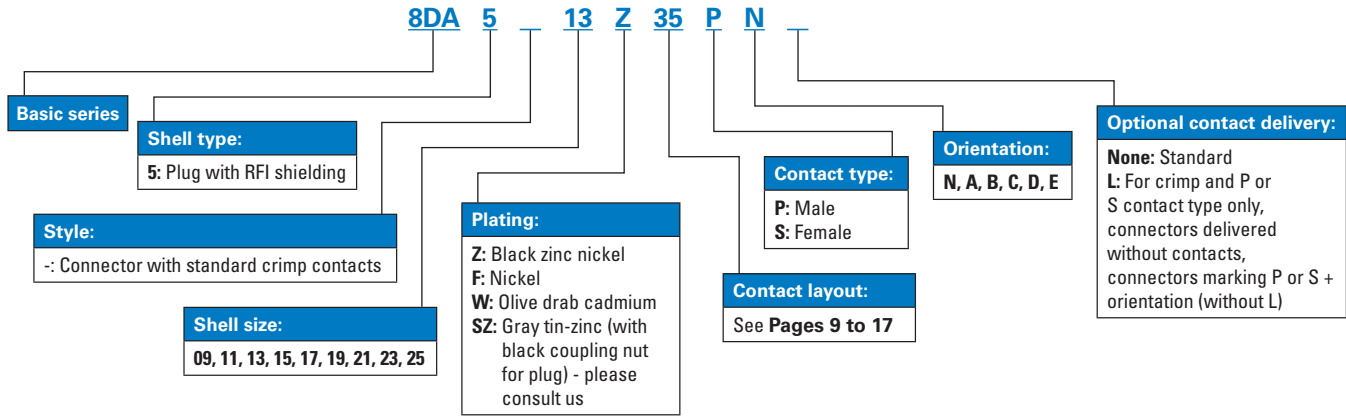

Note: Power, Quadrax and optical layouts, please consult us. Type 0 and Type 7 on request.

Dimensions

Plug type 5

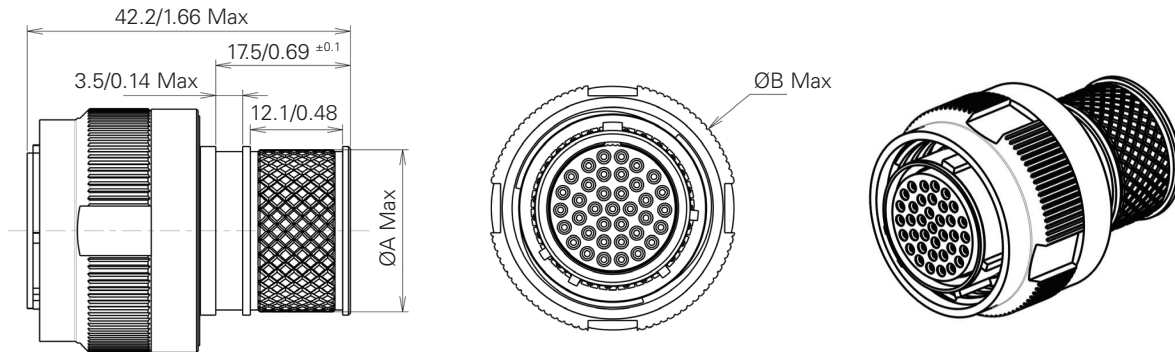

	09	11	13	15	17	19	21	23	25
ØA	11.1/0.44	11.1/0.55	17.1/0.67	21.1/0.83	24.1/0.95	27.1/1.07	30.1/1.18	33.1/1.30	36.1/1.42
ØB	21.8/0.86	25.0/0.98	29.4/1.16	32.5/1.28	35.7/1.41	38.5/1.52	41.7/1.64	44.9/1.77	48.0/1.89

Note: All dimensions are in millimeters and inches (mm/inch)

Connector weight - in grams (±15%)

Shell size & layout	9-35	11-35	13-35	15-35	17-35	19-35	21-35	23-35	25-35
Weight with contacts	14.92	20.62	29.82	40.37	48.33	59.51	70.23	82.41	96.86

Accessories & Tooling

Recommended accessories for wiring

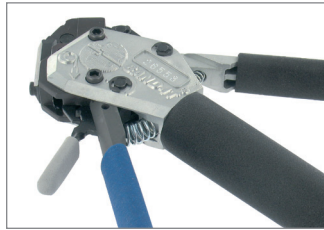

Shell size	Shield band (recommended)	Hand banding tool	Rear diameter to fit with boot
9	M85049/128-8 (individually coiled)	85930339A	11.1/0.44
	M85049/128-7 (not individually coiled)		
11	M85049/128-8 (individually coiled)	85930339A	14.1/0.55
	M85049/128-7 (not individually coiled)		
13	M85049/128-8 (individually coiled)	85930339A	17.1/0.67
	M85049/128-7 (not individually coiled)		
15	M85049/128-8 (individually coiled)	85930339A	21.1/0.83
	M85049/128-7 (not individually coiled)		
17	M85049/128-8 (individually coiled)	85930339A	24.1/0.95
	M85049/128-7 (not individually coiled)		
19	M85049/128-8 (individually coiled)	85930339A	27.1/1.07
	M85049/128-7 (not individually coiled)		
21	M85049/128-8 (individually coiled)	85930339A	30.1/1.18
	M85049/128-7 (not individually coiled)		
23	M85049/128-3 (not individually coiled)	85999346	33.1/1.30
	M85049/128-4 (individually coiled)		
25	M85049/128-3 (not individually coiled)	85999346	36.1/1.42
	M85049/128-4 (individually coiled)		

Shield band dimension

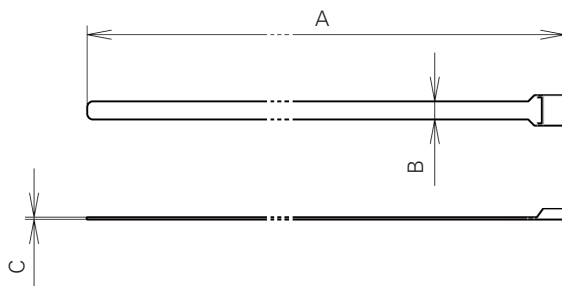

	M85049/128-7 or M85049/128-8	M85049/128-3 or M85049/128-4
A	206.2 ^{+1.5} / 8.12 ^{+0.06}	362 ^{+1.5} / 14.25 ^{+0.06}
B	2.92 / 0.115	6.22 / 2.45
C	0.38 / 0.015	0.48 / 0.019

Souriau 8D series plug with integrated backshell

Accessories

Recommended installation torque

Shell size	Installation torque (inch-pounds)
09, 11, 13, 15, 17 & 19	40
21, 23 & 25	80

Note: Torque values are based on 80% of the coupling thread strength specified in SAE-AS85049 standard.

Tightening support

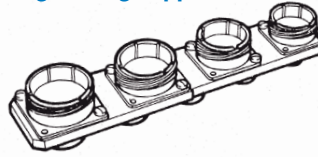

Part number: 8599-0831

This tool is made up of dummy receptacles housings of all nine sizes for all key polarization, and secures free connectors during wiring and fitting of rear accessories.

Crimping tools - for standard contacts

Contact size	Contact type	Contact part number	Plier M22520/1-01	Plier M22520/2-01
			Turret part number MIL Spec	(Souriau 8476-01) Locator part number MIL Spec
#22D	Pin	8599-0702 900	-	M22520/2-09
	Socket	8599-0706 900	-	M22520/2-07
#20	Pin	8599-0703 SA	M22520/1-04	M22520/2-10
	Socket	8599-0707 900	M22520/1-04	M22520/2-10
#16	Pin	8599-0704 MJ	M22520/1-04	-
	Socket	8599-0708 900	M22520/1-04	-
#12	Pin	8599-0705 MJ	M22520/1-04	-
	Socket	8599-0709 900	M22520/1-04	-

Insertion & extraction tools - for standard contacts

Contact size	Material	Part number	Color	
			Insertion	Extraction
#22D	Plastic	M81969/14-01	Green	White
#20	Plastic	M81969/14-10	Red	Orange
#16	Plastic	M81969/14-03	Blue	White
#12	Plastic	M81969/14-04	Yellow	White
#10	Plastic	M81969/14-05	Gray	-

Other accessories, tooling and contacts

See **Page 55**.



Description

High vibration reinforced locking:

- Threaded coupling
- Shell sizes from 9 to 25
- 100% scoop-proof
- RFI - EMI shielding and shell-to-shell conductivity
- Contact fretting minimized
- Accessories available (protective caps, backshells, etc.)
- Intermateable with standards:
 - MIL-DTL-38999 Series III
 - N3645
 - CC63DC

Mechanical

Shell

Stainless steel

Shell plating

- Passivated (K)
- Nickel (S)

Insulator

Thermoplastic

Grommet and interfacial seal

Silicone elastomer

Contacts

Copper alloy

Contacts plating

Gold over nickel plated

Endurance

500 mating cycles

Shock

300g, 3ms according EN2591-402 method A and EIA-364-27

Vibration

- Sinusoidal:
 - 10 à 2000 Hz, 3x12 hrs (60g, 140 - 2000 Hz) with T° cycling
- Random:
 - 50 to 2000 Hz, 2x8 hrs (1g2/ Hz, 100 - 2000Hz) at T° max.
 - 25 to 2000 Hz, 2x8 hrs (5g2/ Hz, 100 - 300Hz) at ambient T°

Test with accessories in accordance with EN2591-403 and EIA-364-28

Contact retention

Contacts size	22	20	16	12	8	4
Min force in N	44	67	111	111	111	200

Electrical

Test voltage rating (Vrms)

Service	Sea level	21 000 m
		70,000 ft
R	400	N/A
M	1 300	800
N	1 000	600
I	1 800	1 000
II	2 300	1 000

Contact resistance

Contact size	22	20	16	12	8	4
Resistance mΩ	14.6	7.3	3.8	3.5	3	2

Insulation resistance

≥ 5,000 MΩ (under 500 Vdc)

Contact rating

Contact size	22	20	16	12	8	4
Rating (A)	5	7.5	13	23	45	80

Shell continuity

- K: 10 mΩ
- S: 1 mΩ

Shielding

- K: 45 db at 10 GHz
- S: 65 db at 10 GHz

Environmental

Temperature range

- K: -65°C +200°C
- S: -65°C +200°C
- Peak temperature: 260°C

Sealing

Mated connectors meet altitude immersion requirements of MIL-DTL-38999.

Salt spray

- K: 500 hrs
- S: 500 hrs

Resistance to fluids

According to MIL-DTL-38999 standard

- Gasoline: JP5 (OTAN F44)
- Mineral hydraulic fluid: MIL-H-5606 (OTAN H515)
- Synthetic hydraulic fluid: Skydrol 500 B4

LD4 (SAE AS 1241)

- Mineral lubricating: MIL-L-7870A (OTAN 0142)
- Synthetic lubricating: MIL-L-23699 (OTAN 0156), MIL-L-7808
- Cleaning fluid: MIL-DTL-25769 diluted
- De-icing fluid: MIL-A-8243
- Extinguishing fluid: Bromochloromethane
- Cooling fluid: Coolanol

Souriau 8DV series high vibration reinforced locking

Overview

8DV overview

- Full stainless steel design provides robustness to withstand for harsh environments, including; vibration, fire resistance, corrosion, temperatures up to 260°C
- Coupling with all types of D38999 receptacles and M85049 backshells
- Reduced contact fretting, contact conductivity guaranteed
- Security lock with vibration levels beyond D38999 standards values
- The lock-on system increases the pressure force between plug and receptacle, providing excellent electrical conductivity between boxes coupled
- Easy implementation of rear accessories at high temperatures when harnessed
- Basic mechanical, electrical and environmental characteristics are identical to stainless steel MIL-DTL 38999 connectors.

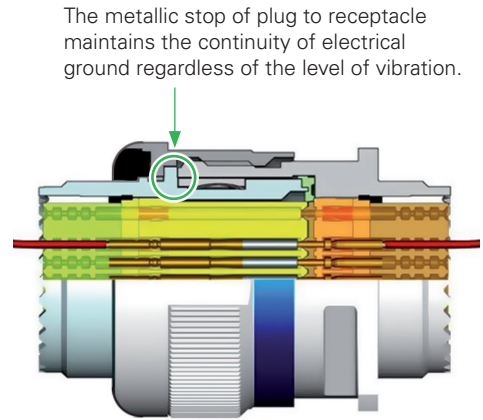

8DV coupling possibilities

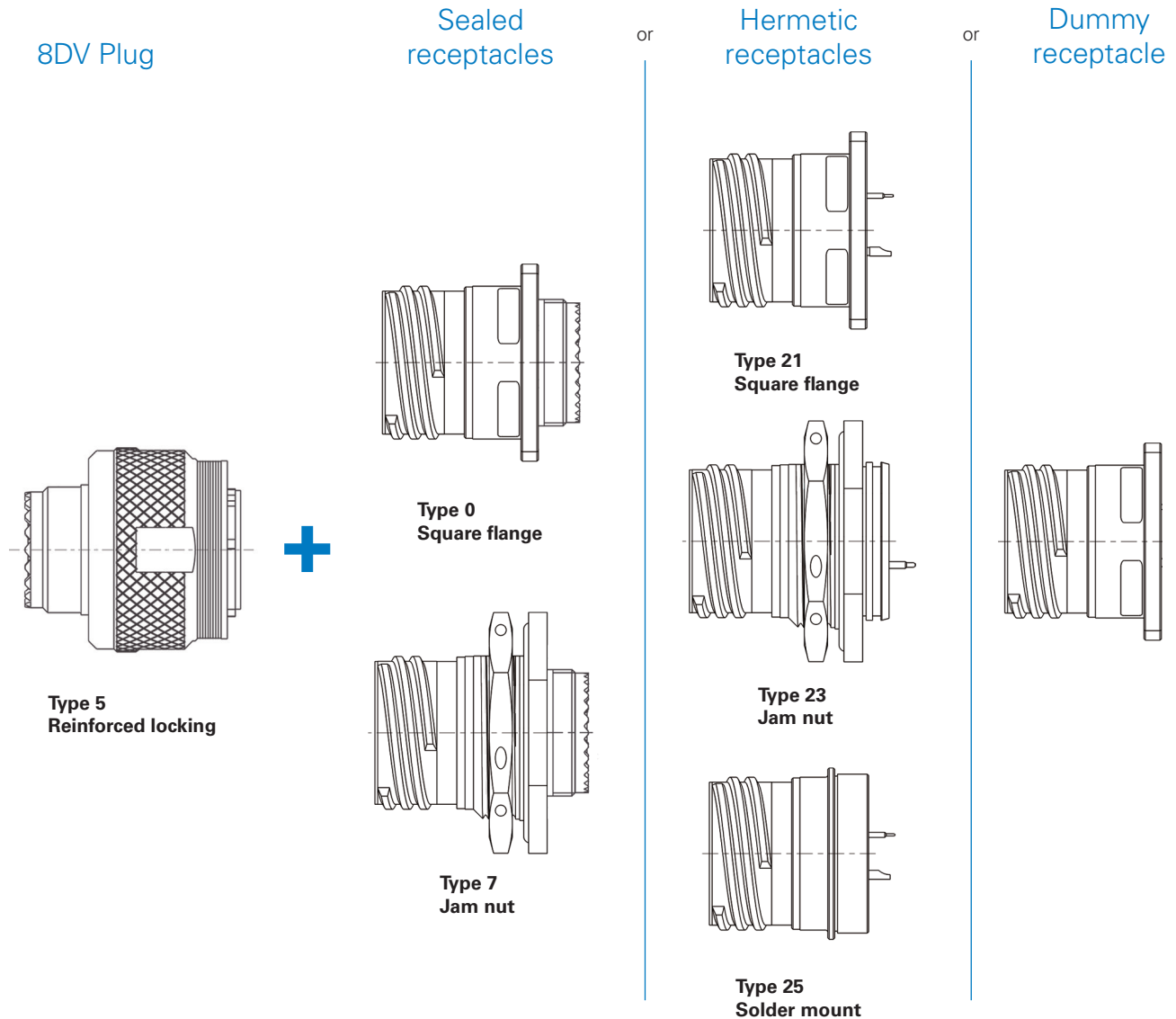

Connector part numbers

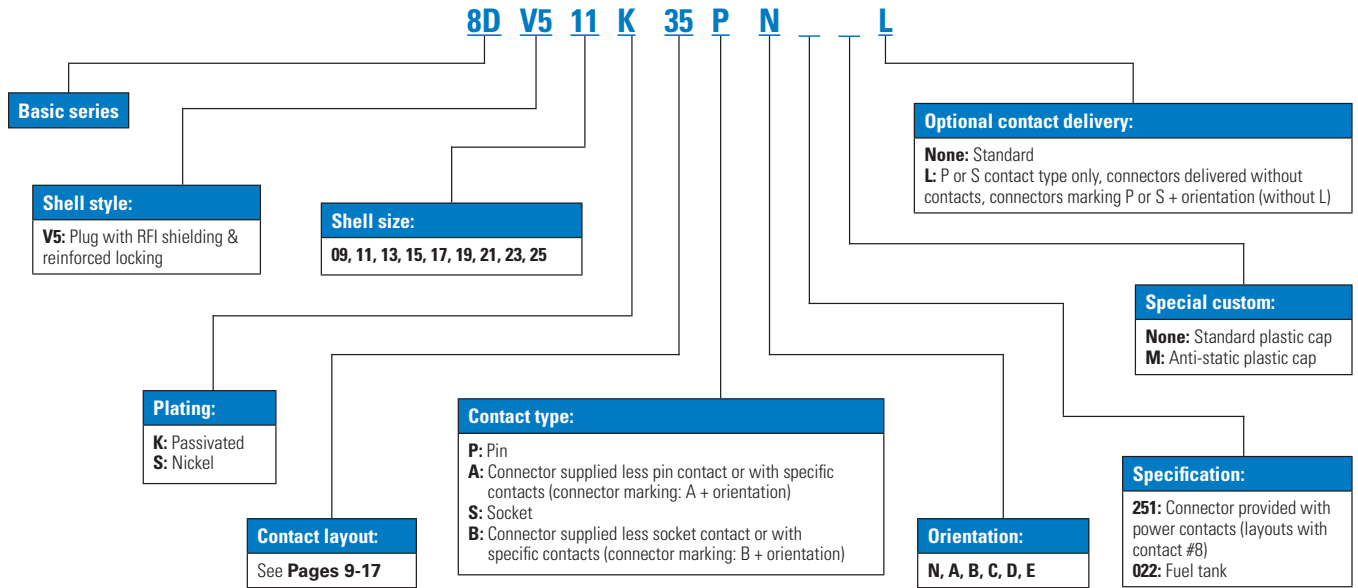

Souriau 8DV series high vibration reinforced locking

Dimensions

Dimensions

Plug type 5 reinforced locking (8DV)

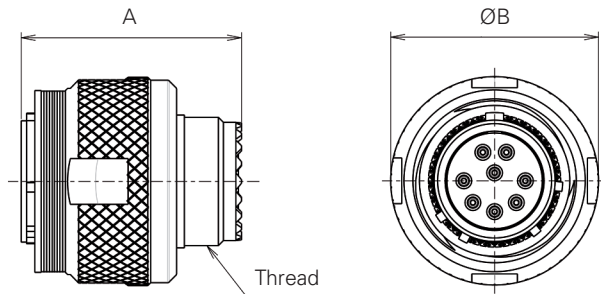

Shell size	A Max	Thread	ØB Max
09 (A)	31.00	M12 x 1-6g	21.80
11 (B)	31.00	M15 x 1-6g	25.00
13 (C)	31.00	M18 x 1-6g	29.40
15 (D)	31.00	M22 x 1-6g	32.50
17 (E)	31.00	M25 x 1-6g	35.70
19 (F)	31.00	M28 x 1-6g	38.50
21 (G)	31.00	M31 x 1-6g	41.70
23 (H)	31.00	M34 x 1-6g	44.90
25 (J)	31.00	M37 x 1-6g	48.00

Mated connectors dimensions

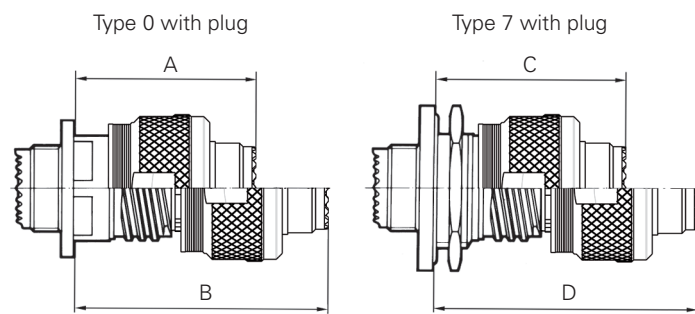

Shell size	A Max	B Max	C Max	D Max
09 (A)	37.00	52.30	38.30	53.60
11 (B)	37.00	52.30	38.30	53.60
13 (C)	37.00	52.30	38.50	53.80
15 (D)	37.00	52.30	38.50	53.80
17 (E)	37.00	52.30	38.50	53.80
19 (F)	37.00	52.30	38.50	53.80
21 (G)	36.00	51.30	38.50	53.80
23 (H)	36.00	51.30	38.50	53.80
25 (J)	36.00	51.30	38.50	53.80

Note: All dimensions are in millimeters (mm).

Connector - weigh - in grams (±10%)

Layout	with contacts		without contacts	
	Male	Female	Male	Female
9-35	32.53	34.11	32.11	32.61
9-98	32.53	33.83	32.11	32.63
11-01	41.53	44.47	40.87	42.87
11-04	41.35	44.41	40.79	42.81
11-05	41.38	44.59	40.68	42.59
11-35	41.28	44.75	40.37	41.50
11-98	41.25	44.01	40.41	41.61
13-04	56.64	60.42	55.40	57.30
13-08	57.02	62.20	55.90	59.00
13-26	57.39	63.04	55.65	58.34
13-35	56.82	62.59	55.28	57.09
13-98	56.68	61.30	55.28	57.30
15-05	68.49	73.83	66.94	69.93
15-15	69.29	76.45	67.02	70.07
15-18	69.50	78.38	66.98	71.18
15-19	69.03	76.76	66.37	69.16
15-35	69.13	78.37	66.54	69.12
15-97	68.96	76.01	66.60	69.69
17-06	73.97	83.57	70.01	73.97
17-08	72.96	81.69	70.48	75.45
17-26	73.54	84.33	69.90	73.93
17-35	73.78	87.33	69.93	73.58
17-75	79.38	90.67	70.38	76.67
17-99	73.59	84.15	70.03	74.19

Layout	with contacts		without contacts	
	Male	Female	Male	Female
19-11	87.99	101.58	84.58	93.00
19-32	87.20	100.60	82.72	87.80
19-35	87.51	103.96	82.89	87.46
21-11	101.71	121.55	94.45	103.95
21-16	98.81	114.09	93.85	101.61
21-35	99.09	119.75	93.56	100.00
21-39	100.47	120.80	94.67	104.44
21-41	99.01	116.38	93.27	99.98
23-21	118.01	141.26	111.50	124.88
23-35	116.37	142.52	109.37	117.52
23-53	116.43	138.62	109.01	117.42
23-55	117.18	140.25	109.48	118.25
25-19	130.34	162.35	117.80	131.95
25-24	129.84	161.20	118.20	132.64
25-29	128.16	157.13	119.17	134.51
25-35	125.95	158.78	116.99	126.78
25-43	128.20	158.88	118.78	134.08
25-46	130.50	154.34	115.86	126.02
25-61	125.25	152.00	116.71	127.60
25-08	151.58	183.41	115.58	127.41
25-20	136.60	166.82	115.03	125.28
25-04	129.00	158.85	119.80	133.41



Description

- Square flange receptacle with four clinch nuts or four helicoils
- Self locking clinch nut & helicoils
 - Rear mounting
 - Easy to install, time saving
 - Equivalent MIL level qualification as 38999 Series III
 - Clinch nut & helicoil tested:
 - Impact test (drop 0.4kg from height of 100mm)
 - Push out test (130N during 15s max)
 - Wrench out test (1N/m)

Mechanical

Shell:

Aluminum

Shells plating

- Black zinc nickel (Z)
- Cadmium olive drab (W)
- Nickel (F)
- Gray tin-zinc (with black coupling nut for plug) (SZ) - please consult us

Insulator

Thermoplastic

Grommet and interfacial seal:

Silicone elastomer

Contact

Copper alloy

Contact plating

Gold over nickel plated

Endurance

500 mating/unmating operations

Shock

300g, 3ms

Vibration

- Sinus:
 - 10 à 2000 Hz, 3x12 hrs (60g, 140 - 2000 Hz) with T° cycling
- Random:
 - 50 to 2000 Hz, 2x8 hrs (1g2/ Hz, 100 - 2000Hz) at T° max.
 - 25 to 2000 Hz, 2x8 hrs (5g2/ Hz, 100 - 300Hz) at ambient T°

Contact retention

Contacts size	26	22	20	16	12	8	4
Min force in N	30	44	67	111	111	111	200

Electrical

Test voltage rating (Vrms)

Service	Sea level	at 21000 m
R	400	N/A
M	1 300	800
N	1 000	600
I	1 800	1 000
II	2 300	1 000

Contact resistance

Contacts size	26	22	20	16	12	8	4
Resistance mΩ	16	14.6	7.3	3.8	3.5	3	2

Insulation resistance

≥ 5 000 MΩ (under 500 Vdc)

Contact rating

Contacts size	26	22	20	16	12	8	4
Rating (A)	3	5	7.5	13	23	45	80

Shell continuity

- Black zinc nickel (Z): 2.5 mΩ
- Cadmium olive drab (W): 2.5 mΩ
- Nickel (F): 1 mΩ

Shielding

- F: 65 db at 10 GHz
- Z, F & W: 85 db at 1 GHz
- Z & W: 50 db at 10 GHz

Environmental

Temperature range

- W: -65°C +175°C
- Z & F: -65°C +200°C

Sealing

Mated connectors meet altitude immersion requirements of MIL-DTL-38999

Salt spray

- Z & W: 500 hours
- F: 48 hours

Resistance to fluids

According to MIL-DTL-38999 standard

- Gasoline: JP5 (OTAN F44)
- Mineral hydraulic fluid: MIL-H-5606 (OTAN H515)
- Synthetic hydraulic fluid: Skydrol 500 B4

LD4 (SAE AS 1241)

- Mineral lubricating: MIL-L-7870A (OTAN 0142)
- Synthetic lubricating: MIL-L-23699 (OTAN 0156), MIL-L-7808
- Cleaning fluid: MIL-C-87936 diluted
- De-icing fluid: MIL-A-8243
- Extinguishing fluid: Bromochloromethane
- Cooling fluid: Coolanol

Souriau 8D series receptacle with clinch nuts or helicoils

Part numbers

Ordering information

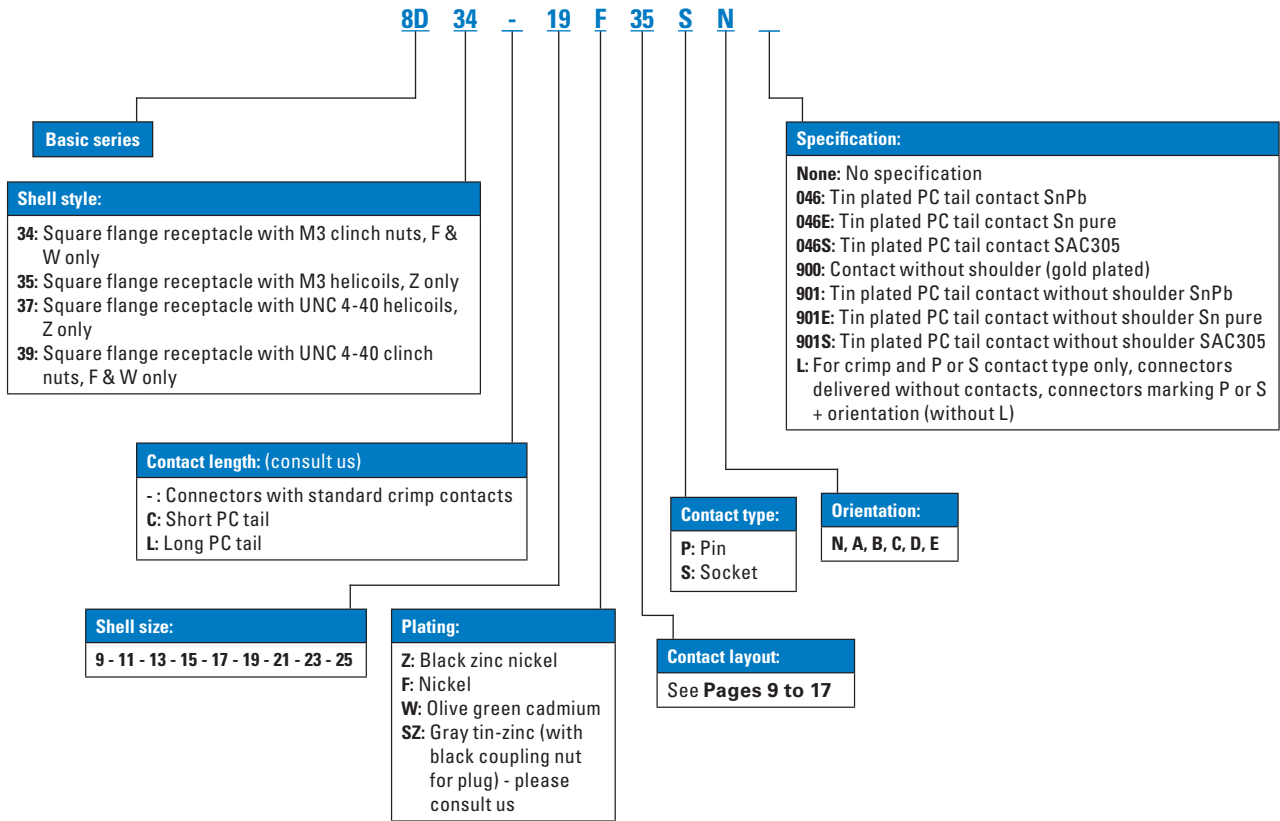

Dimensions

Mounted connectors (with 8D5 connector)

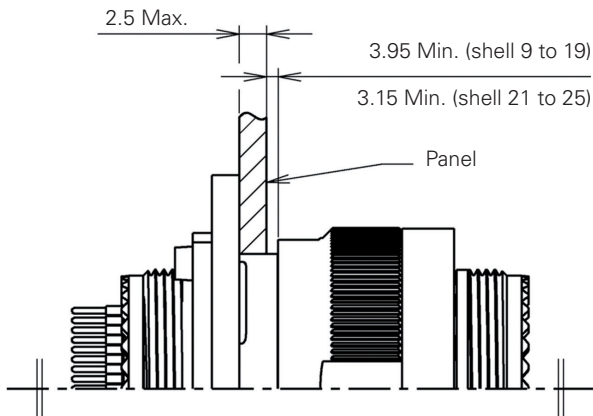

Note: All dimensions are in millimeters (mm).

Dimensions

Square flange receptacle - type 34 & type 39

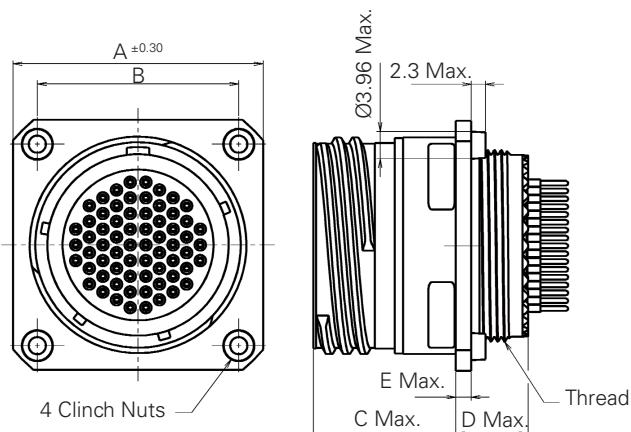

Shell Size	A ^{+0.3}	B	C Max	D Max	E Max	Thread
9	27.79	18.26	20.90	10.60	2.50	M12x1-6g
11	30.15	20.62	20.90	10.60	2.50	M15x1-6g
13	32.54	23.01	20.90	10.60	2.50	M18x1-6g
15	34.14	24.61	20.90	10.60	2.50	M22x1-6g
17	36.5	26.97	20.90	10.60	2.50	M25x1-6g
19	38.89	29.36	20.90	10.60	2.50	M28x1-6g
21	41.27	31.75	20.10	11.40	3.20	M31x1-6g
23	44.45	34.93	20.10	11.40	3.20	M34x1-6g
25	47.62	38.1	20.10	11.40	3.20	M37x1-6g

Contact length
See Page 23.

Square flange receptacle - type 35 & type 37

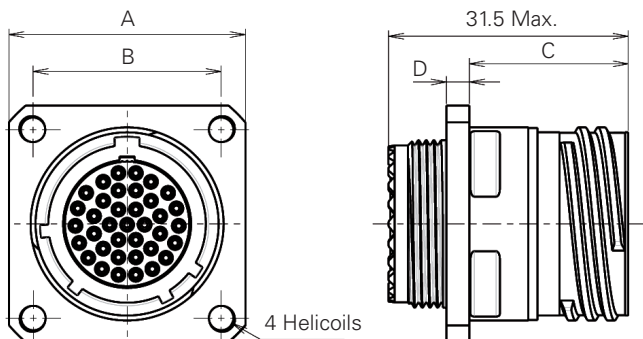

Shell size	A	B	C	D
9	24	18.26	20.9	4.3
11	26.4	20.62	20.9	4.3
13	28.8	23.01	20.9	4.3
15	31.2	24.61	20.9	4.3
17	33.5	26.97	20.9	4.3
19	36.7	29.36	20.9	4.3
21	39.9	31.75	20.1	4.3
23	43.1	34.93	20.1	4.3
25	46.2	38.1	20.1	4.3

Contact length
Please contact us.

Note: All dimensions are in millimeters (mm).

Souriau 8D series double flange

Technical specifications

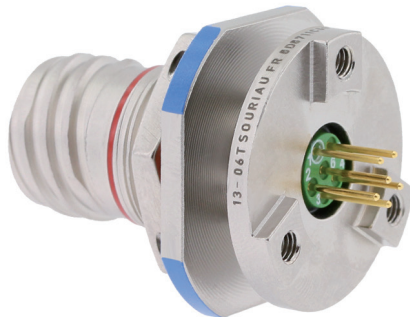

Mechanical

Shell

Aluminum

Shell plating

- Cadmium olive drab (W)
- Nickel (F)
- Black zinc nickel (Z)
- Gray tin-zinc (with black coupling nut for plug) (SZ) - please consult us

Insulator

Thermoplastic

Grommet and interfacial seal

Silicone elastomer

Contacts

Copper alloy

Contacts plating

Gold over nickel plated

Endurance

500 mating cycles

Shock

300g, 3ms

Vibration

- Sinus:
 - 10 à 2000 Hz, 3x12 hrs (60g, 140 - 2000 Hz) with T° cycling
- Random:
 - 50 to 2000 Hz, 2x8 hrs (1g2/ Hz, 100 - 2000Hz) at T° max.
 - 25 to 2000 Hz, 2x8 hrs (5g2/ Hz, 100 - 300Hz) at ambient T°

Contact retention

Contacts size	22	20	16	12
Min force in N	44	67	111	111

Electrical

Test voltage rating (Vrms)

Service	sea level	at 21000 m
M	1 300	800
N	1 000	600
I	1 800	1 000
II	2 300	1 000

Contact resistance

Contacts size	22	20	16	12
Resistance mΩ	14.6	7.3	3.8	3.5

Insulation resistance

≥ 5 000 MΩ (under 500 Vdc)

Contact rating

Contacts size	22	20	16	12
Rating (A)	5	7.5	13	23

Shell continuity

- Cadmium olive drab (W): 2.5 mΩ
- Nickel (F): 1 mΩ
- Black zinc nickel (Z): 2.5 mΩ
- Gray tin-zinc (with black coupling nut for plug) (SZ): 2.5 mΩ

Shielding

- F: 65 db at 10 GHz; 85 db at 1 GHz
- W: 50 db at 10 GHz
- Z & SZ: Consult us

Description

- High level vibration resistance in harsh environments
- Offers the same level of performance as the MIL-DTL-38999 Series III connector
- Jam nut or square flange receptacle
- No risk of breaking contacts
- No risk of micro-cuts
- Allow direct grounding from PCB to the flange
- PC tails contacts without shoulder: #12, #16, #20 and #22
- Resin sealed version also available

Environmental

Temperature range

- W: -65°C +175°C
- F: -65°C +200°C
- Z: -65°C +175°C
- SZ: -65°C +175°C

Sealing

Mated connectors meet altitude immersion requirements of MIL-DTL-38999.

Salt spray

- W: 500 hrs
- F: 48 hrs
- Z: 500 hrs
- SZ: 500 hrs

Resistance to fluids

According to MIL-DTL-38999 standard

- Gasoline: JP5 (OTAN F44)
- Mineral hydraulic fluid: MIL-H-5606 (OTAN H515)
- Synthetic hydraulic fluid: Skydrol 500 B4

LD4 (SAE AS 1241)

- Mineral lubricating: MIL-L-7870A (OTAN 0142)
- Synthetic lubricating: MIL-L-23699 (OTAN 0156), MIL-L-7808
- Cleaning fluid: MIL-C-87936 diluted
- De-icing fluid: MIL-A-8243
- Extinguishing fluid: Bromochloromethane
- Cooling fluid: Coolanol

Ordering information

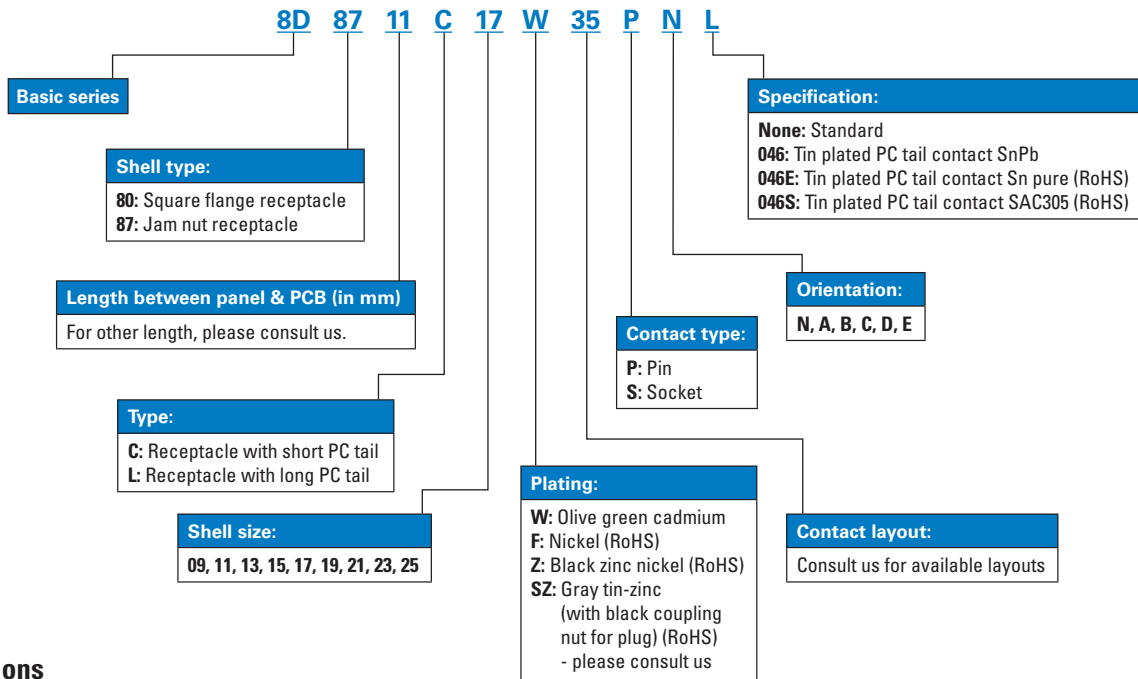

Dimensions

Jam nut receptacle (type 87)

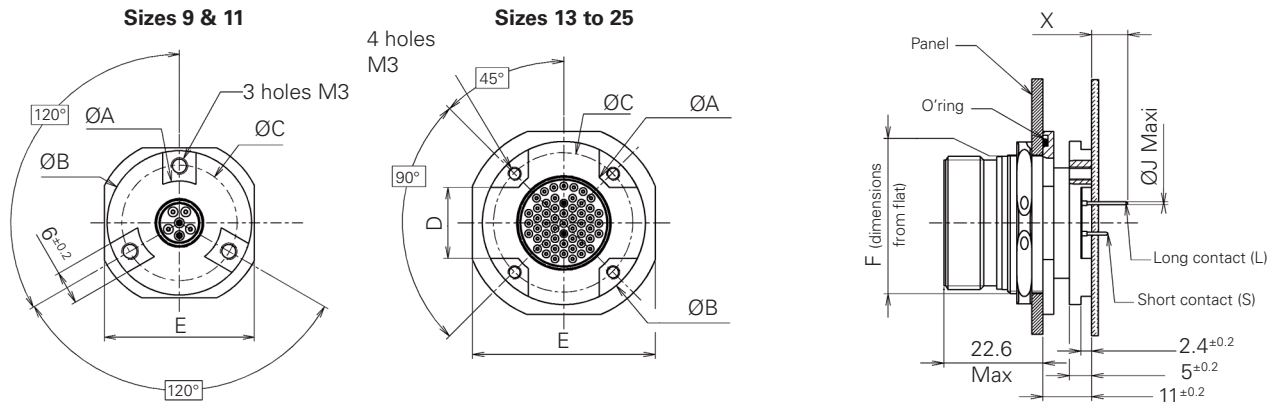

Shell size	ØA ±0.15	ØB ±0.15	ØC	D ^{+0.2} ₋₀	E ±0.4	F ^{+0.1} _{-0.15}
9	15.10	26.00	20.50	-	27.00	16.53
11	19.90	30.80	25.20	-	31.80	19.07
13	19.90	30.80	25.25	12	34.90	23.82
15	23.00	33.90	28.42	14	38.10	26.97
17	26.00	36.80	31.42	16	41.30	30.15
19	29.50	40.40	35.03	18	46.00	33.32
21	32.50	43.20	37.82	20	49.20	36.50
23	35.50	46.50	41.12	23	52.40	39.67
25	38.60	49.60	44.30	25	55.60	42.85

Contact size	Contact type	PC tail length	Size 09 & 11 X Min	Size 13 to 25 X Min	ØJ max
22D	M & F	Long	7.1	7.1	0.7
	M & F	Short	3.6	3.6	0.7
20	M & F	Long	7.1	7.1	0.9
	M & F	Short	3.6	4.2	0.9
16	M & F	Long	7.1	7.1	1.35
	M & F	Short	3.6	4.2	1.35
12	M & F	Long	6.76	5.6	1.35
	M & F	Short	3.76	2.6	1.35

Note: All dimensions are in millimeters (mm).

Souriau 8D series double flange

Dimensions

Square flange receptacle (type 80)

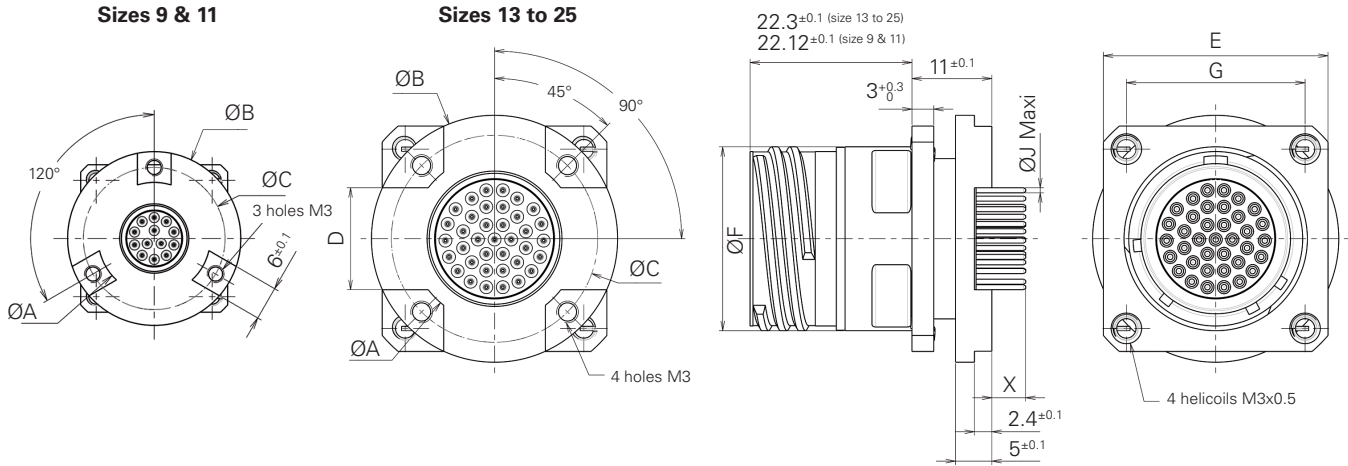

Shell size	ØA ±0.1	ØB ±0.1	ØC ±0.1	D ±0.1	E ±0.2	ØF ±0.1	G ±0.1
9	15.1	26	20.5	-	23.75	15.67	18.26
11	19.9	30.8	25.2	-	26.14	18.67	20.62
13	19.9	30.8	25.25	12	28.55	22.07	23.01
15	23	33.9	28.42	14	30.94	25.25	24.61
17	26	36.8	31.42	16	33.25	30	26.97
19	29.5	40.4	35.03	18	36.45	31.57	29.36
21	32.5	43.2	37.82	20	39.65	34.75	31.75
23	35.5	46.5	41.12	23	42.85	37.92	34.93
25	38.6	49.6	44.3	25	45.95	41.1	38.1

Contact size	Contact type	PC tail length	Size 09 & 11		Size 13 to 25		ØJ max
			X Min	X Min	X Min	max	
22D	M	Long	7.39	7.21	0.70		
		Short	4.39	4.21	0.70		
	F	Long	7.12	6.94	0.70		
		Short	4.12	3.94	0.70		
20	M	Long	7.39	7.21	0.90		
		Short	4.39	4.21	0.90		
	F	Long	7.40	7.22	0.90		
		Short	4.40	4.22	0.90		
16	M	Long	7.39	7.21	1.35		
		Short	4.39	4.21	1.35		
	F	Long	7.34	7.16	1.35		
		Short	4.34	4.16	1.35		
12	M	Long	7.40	7.22	1.35		
		Short	4.40	4.22	1.35		
	F	Long	7.41	7.23			
		Short	4.41	4.23			

Note: All dimensions are in millimeters (mm).

Comparison

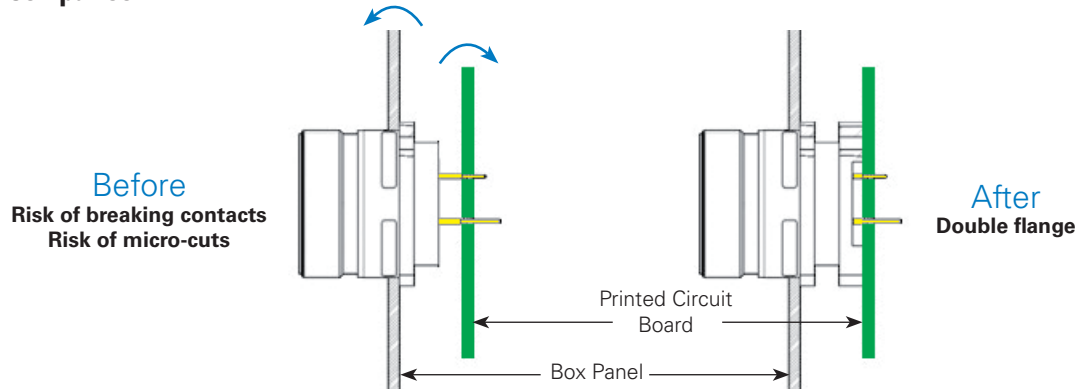

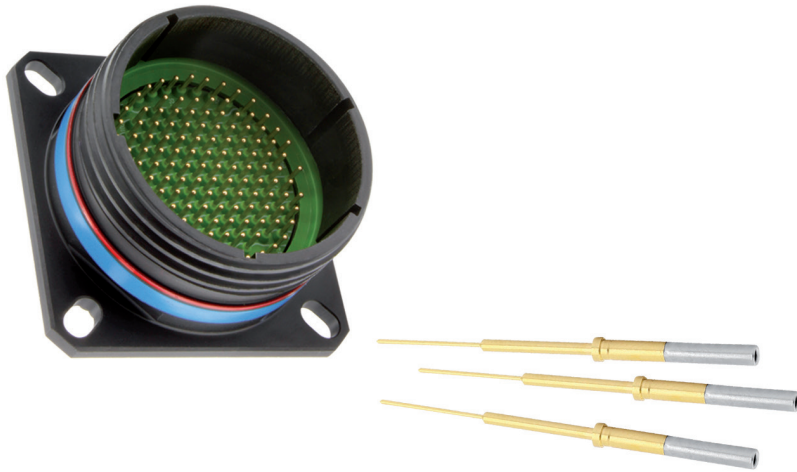

Description

- Pin & socket PCB contacts without shoulder #20 & #22D per MIL-DTL-38999 Series I, II & III
- Contacts without shoulder allow more flexible mounting on variable PCB thicknesses or depths
- Ruggedized contacts:
 - Material: Copper alloy
 - Finish: Gold per MIL-G-45204 type I class 1 over nickel plate
 - Sleeve: Stainless steel
- Flexible mounting:
 - Various PCB thicknesses
 - Multiple PCB positioning

Ordering information

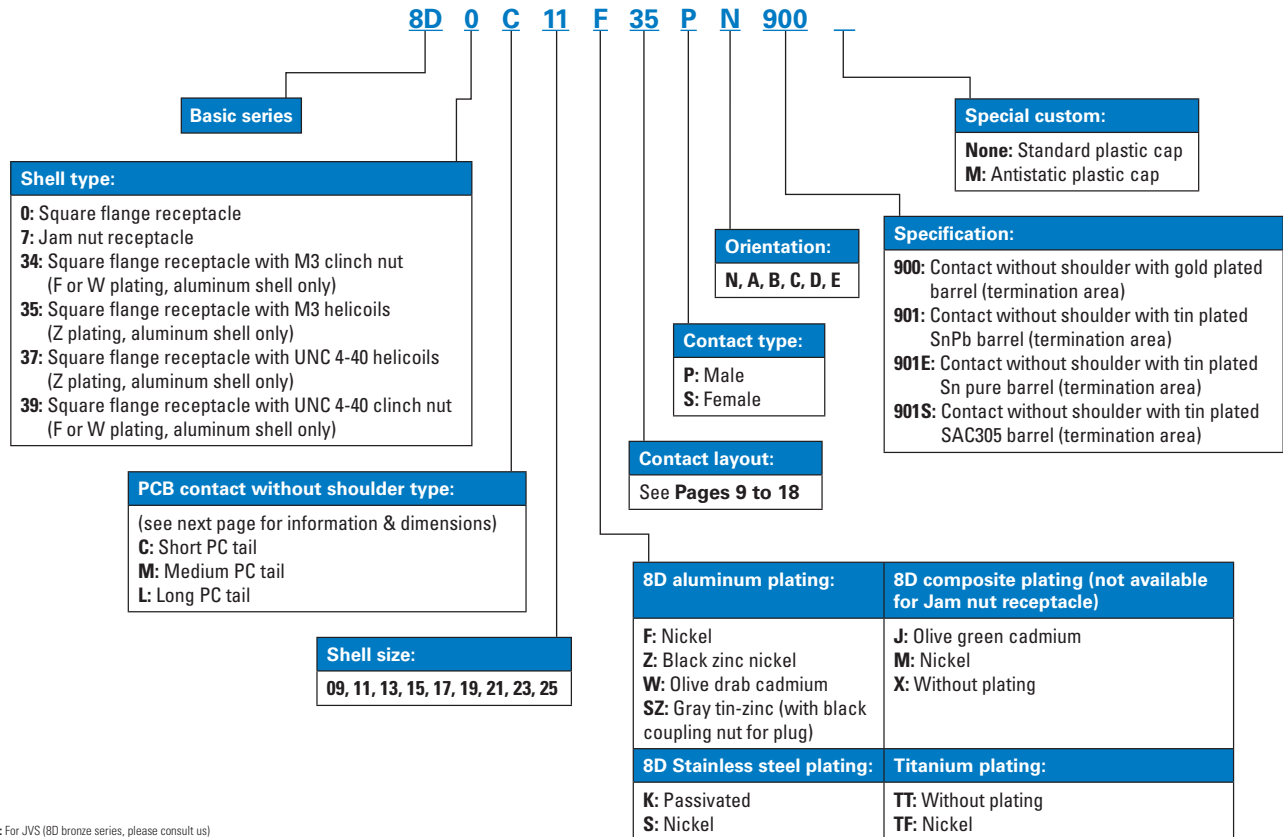

Note: For JVS (8D bronze series, please consult us)

Souriau 8D series PCB contacts without shoulder

Dimensions

Dimensions

Type 0 & type 7

**Square flange receptacle
8D0
(8D34 / 8D35 / 8D37 / 8D39)**

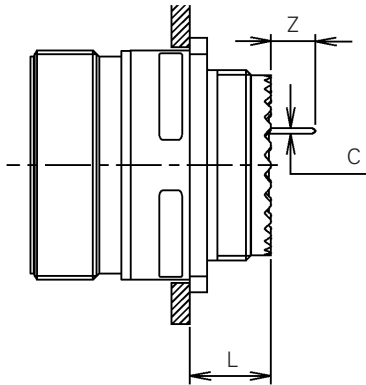

**Jam nut receptacle
8D7**

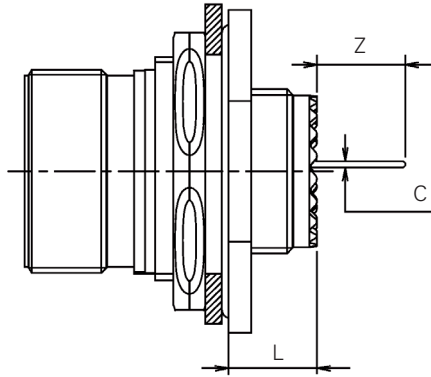

Contact size	Contact Type		Square flange receptacle 8D0 / 8D34 / 8D35 / 8D37 / 8D39			Jam nut receptacle 8D7	
			Ø C Max	Z Min	Z Max	Z Min	Z Max
#22D & #20	Pin	C: Short PC tail	0.50	3.96	4.88	3.56	4.63
		M: Medium PC tail	0.50	5.99	6.91	5.59	6.66
		L: Long PC tail	0.50	7.51	8.43	7.11	8.18
#22D & #20	Socket	C: Short PC tail	0.50	3.96	5.21	3.56	4.81
		M: Medium PC tail	0.50	5.99	7.24	5.59	6.84
		L: Long PC tail	0.50	7.51	8.76	7.11	8.36

Shell type	Square flange receptacle 8D0 / 8D34 / 8D35 / 8D37 / 8D39	Jam nut receptacle 8D7
Shell size	9 to 19	21 to 25
L Max	10.7	9.90

Note: All dimensions are in millimeters (mm).

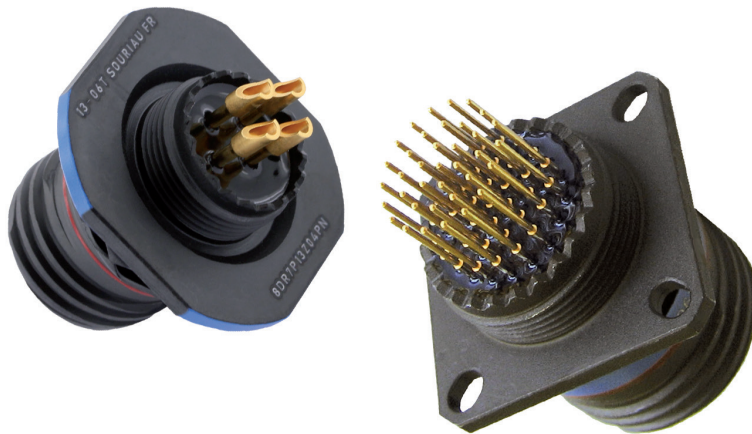

Description

- Reinforced sealed receptacle with male or female straight PC tail contacts
- Strong sealing performance: 10^{-7} atm.cm³/s
- Designed for unpressurized area
- 125°C max (operational temperature)
- 100% Scoop-proof
- Full RoHS solution
- High density connectors
- Weight saving compared to hermetic version

Mechanical

Shell plating

- 8D Aluminum shell:
 - Black zinc nickel (Z)
 - Olive drab cadmium (W)
 - Nickel (F)
 - Gray tin-zinc (with black coupling nut for plug) (SZ)
- 8D Composite shell:
 - Olive drab cadmium (J)
 - Nickel (M)
- 8D Stainless steel shell:
 - Nickel (S)
 - Passivated (K)
- 8D Titanium shell:
 - Nickel (TF)
 - Without plating (TT)

Insulator

Thermoplastic

Interfacial seal

Silicone elastomer

Contacts

Copper alloy

Contacts plating

Gold over nickel plated

Endurance

500 mating/unmating operations

Electrical

Contact resistance

Contacts size	22	20	16
Resistance mΩ	14.6	7.3	3.8

Shielding

- F; S; TF: 65db - 10GHz
- F; Z; SZ; W; J; M: 85db - 1GHz
- Z; SZ; W: 50db - 10GHz
- K; TT: 45db - 10GHz

Shell continuity

- F; TF; S: 1mΩ
- Z; ZC; SZ; W: 2.5mΩ
- J; M: 3mΩ
- JVS: 5mΩ
- TT; K: 10mΩ

Environmental

Temperature range

-55°C +125°C

Sealing (initial)

10^{-7} atm.cm³/s

Salt spray

- F; S; TF: 48h
- Z; SZ; W; JVS; TT; K; S: 500h
- J; M: 2000h

Souriau 8D series reinforced sealing

Part numbers

Ordering information

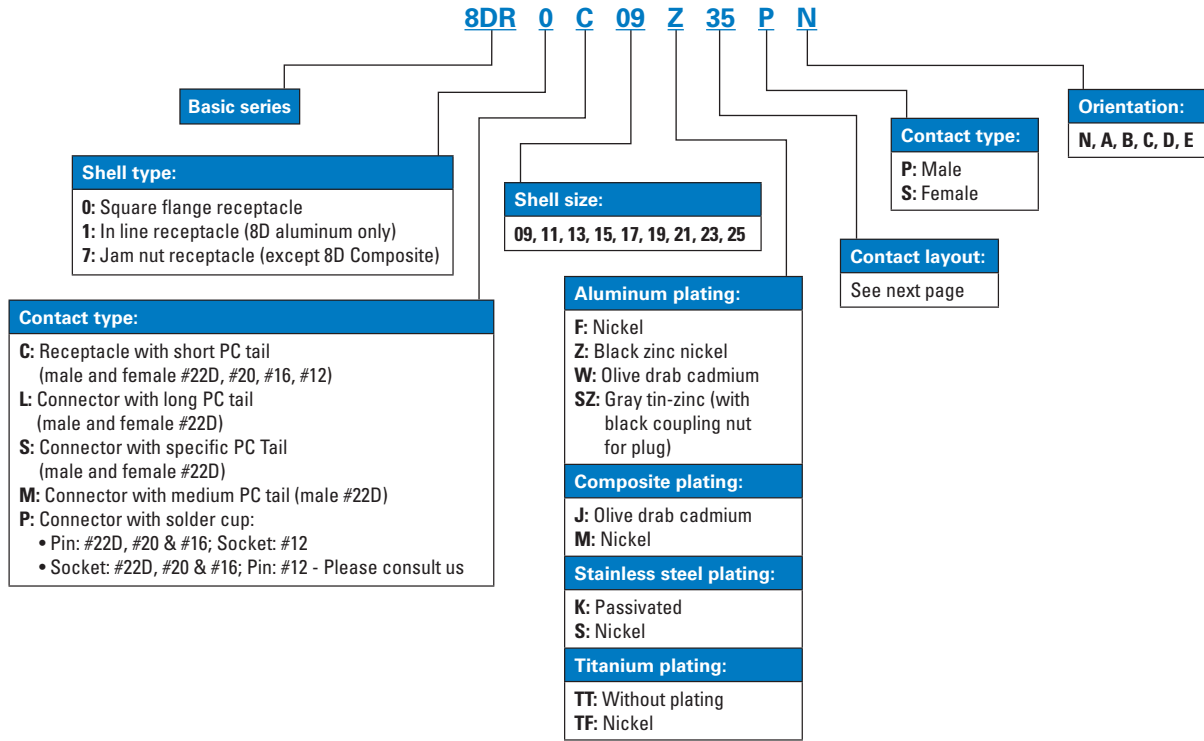

Double flange receptacle available
 Receptacle with integrated clinch nuts or helicoils available
 Contacts without shoulder available

Contact layouts

For C or L contact type.



09 / A

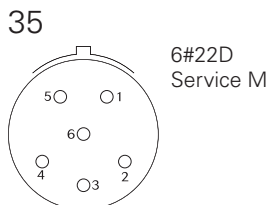

11 / B

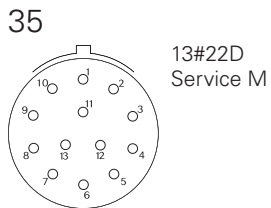

13 / C

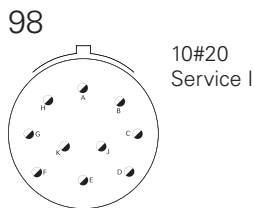
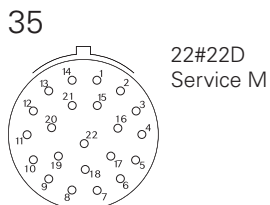

15 / D

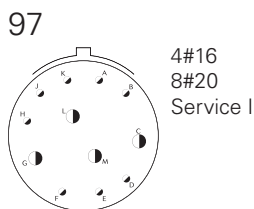
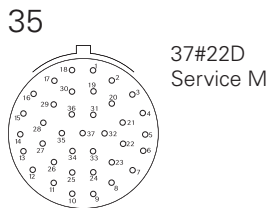
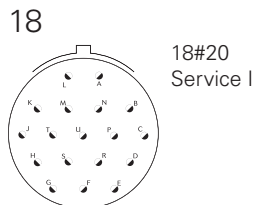

17 / E

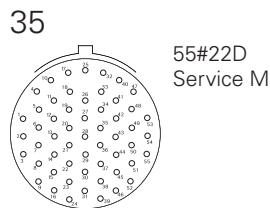

19 / F

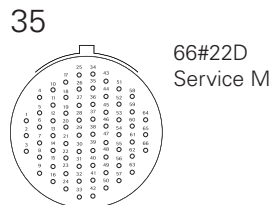

21 / G

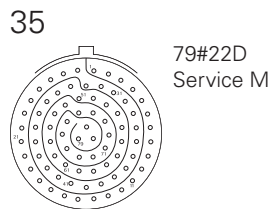

23 / H

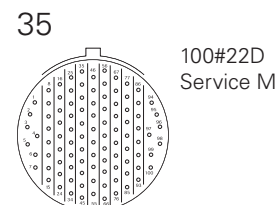

25 / J

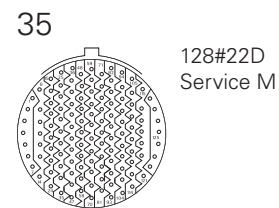

61



Souriau 8D series hermetic series

Technical specifications

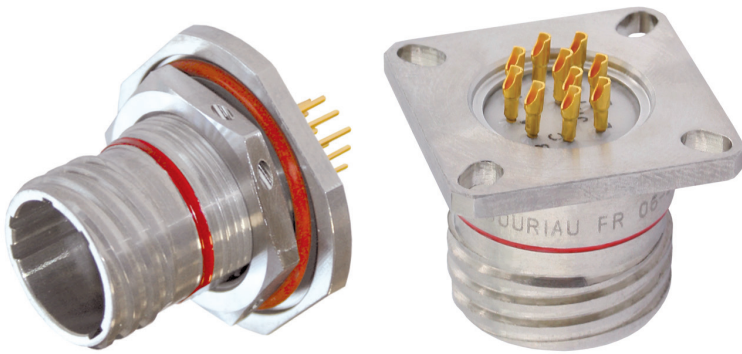

Description

- Thread coupling connector
- MIL-DTL-38999 Series III qualified, EN3645 compliant
- Glass sealed hermetic:
 - High hermeticity performance
 - Compact low profile
- Various mounting styles:
 - Compact solder mount receptacle
 - Easy to install square flange receptacle
 - Easy to replace jam nut receptacle
- Signal and power contacts - up to size #4
- Special fuel tank versions for long-term fuel immersion
- 230V qualified versions where higher voltage is used to reduce cable weight
- Solder cup, PC tail or eyelet contacts

Mechanical

Shell

- Class Y: Passivated stainless steel
- Class N: Nickel plated stainless steel

Seals

Silicone elastomer

Contact

Gold plated ferrous alloy

Endurance

500 mating/unmating operations

Electrical

Max current rating per contact

Contact size	22D	20	16	12	8	4
Rating (A)	3	5	10	17	33	60

Dielectric withstanding voltage

Service	Sea level	30 000 m
M	1 300 Vrms	800 Vrms
I	1 800 Vrms	1 000 Vrms
II	2 300 Vrms	1 000 Vrms

Insulation resistance

5000 M Ω (under 500 Vdc)

Environmental

Operating temperature

-65°C to 200°C

Hermeticity

Leak rate < 1.10⁻⁷ atm.cm³/s (helium gas test)

Salt spray

- Class Y: 500 hours
- Class N: 48 hours

Contact layouts

See Pages 9 to 17.

Contact layouts (matrix)

Shell size	Layout	D38999					Number of contacts					
		QPL	8D type 21 Spec. 600*	8D Spec. 022*	8D Spec. 840 & 850* A76*	8D Spec. A76*	#22D	#20	#16	#12	#8	#4
09 / A	09-35	Q		OK	OK		6					
	09-98	Q		OK	OK			3				
11 / B	11-02	Q			OK				2			
	11-04	Q			OK			4				
	11-05	Q			OK			5				
	11-12	OK	Available on request, please consult us							1		
	11-22	OK	Available on request, please consult us				4					
	11-35	Q		OK	OK	OK	13					
	11-98	Q			OK			6				
	11-99	Q		OK	OK			7				
13 / C	13-03	OK	Available on request, please consult us						3			
	13-04	Q	OK		OK				4			
	13-08	Q			OK			8				
	13-26	OK	Available on request, please consult us				6			2		
	13-35	Q		OK	OK		22					
	13-98	Q			OK			10				
15 / D	15-05	Q	Available on request, please consult us						5			
	15-15	Q	Available on request, please consult us					14	1			
	15-18	Q			OK			18				
	15-19	Q		OK	OK			19				
	15-35	Q		OK	OK	OK	37					
	15-97	Q	Available on request, please consult us					8	4			
17 / E	17-06	Q	OK	OK						6		
	17-08	Q	OK		OK				8			
	17-20	OK	Available on request, please consult us				16			4		
	17-26	Q			OK			26				
	17-35	Q		OK	OK	OK	55					
	17-99	Q	Available on request, please consult us					21	2			
19 / F	19-11	Q	Available on request, please consult us						11			
	19-28	Q	Available on request, please consult us					26	2			
	19-32	Q	Available on request, please consult us					32				
	19-35	Q			OK		66					
21 / G	21-11	Q								11		
	21-16	Q	Available on request, please consult us						16			
	21-35	Q		OK	OK		79					
	21-39	Q	Available on request, please consult us					37	2			
	21-41	Q			OK			41				
	21-48	OK	OK								4	
	21-59	OK	Available on request, please consult us				55			4		
23 / H	23-21	Q			OK				21			
	23-32	Q	Available on request, please consult us					32				
	23-35	Q			OK		100					
	23-53	Q			OK			53				
	23-54	OK	Available on request, please consult us				40		9	4		
	23-55	Q			OK			55				
25 / J	25-04	Q			OK			48	8			
	25-19	Q								19		
	25-24	Q	Available on request, please consult us						12	12		
	25-29	Q			OK				29			
	25-35	Q	Available on request, please consult us				128					
	25-37	Q	Available on request, please consult us						37			
	25-43	Q	Available on request, please consult us					23	20			
	25-44	OK	Available on request, please consult us						4			4
	25-61	Q	Available on request, please consult us					61				

OK = Souriau's layout

Q = Souriau's qualified layout

*See next page for specifications details

Souriau 8D series hermetic series

Part numbers

Connector part numbers

MIL-DTL-38999 part number

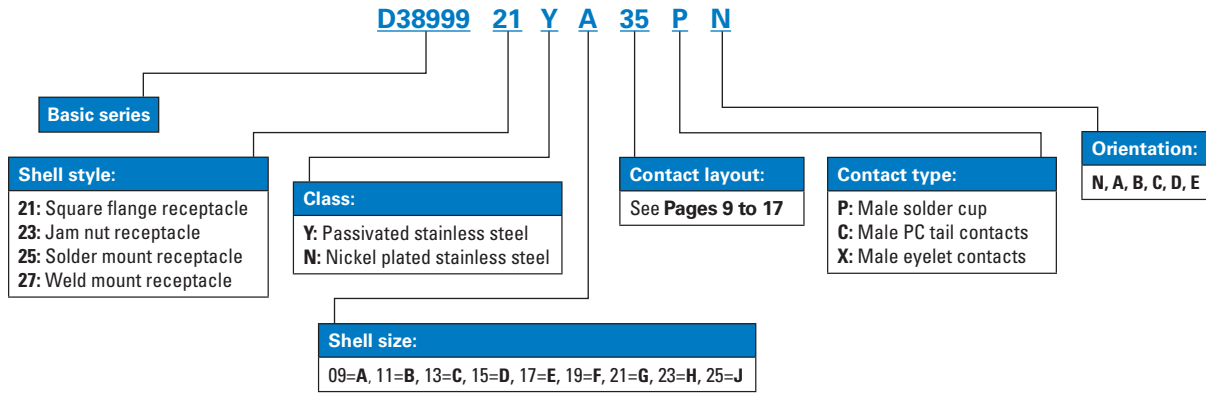

Souriau part numbers

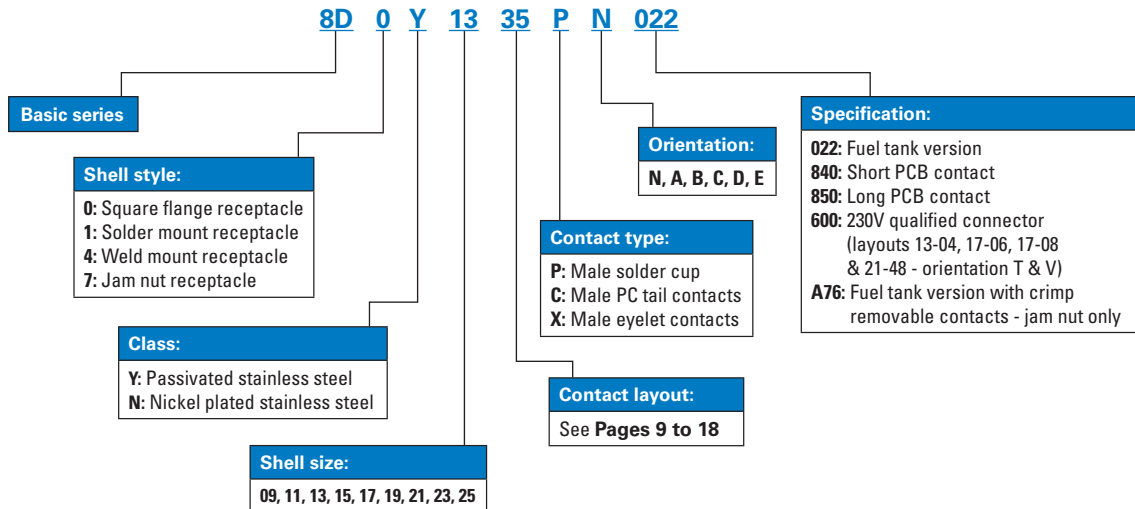

Dimensions

Square flange receptacle (type 21)

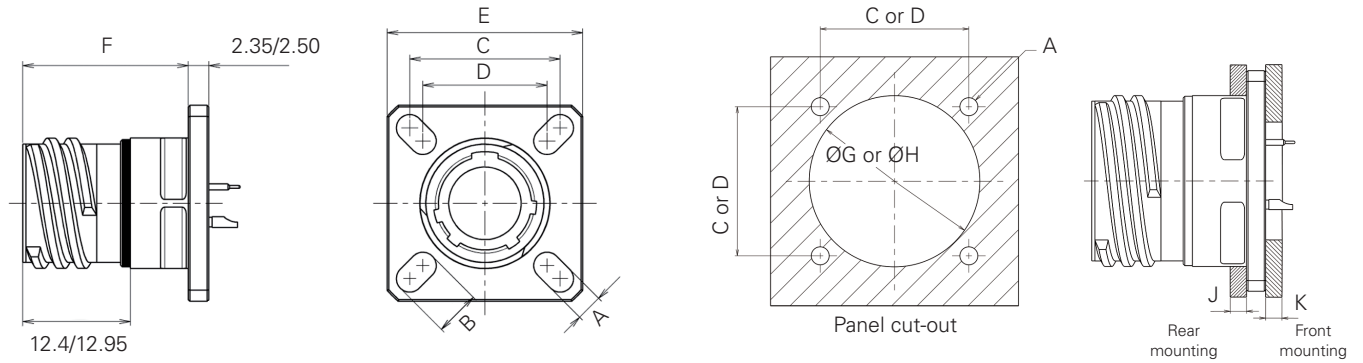

Shell size	A ±0.20	B ±0.20	C	D	E ±0.30	F max	ØG Front mounting	ØH Rear mounting	J max	K max
A (9)	3.25	5.49	18.26	15.09	23.80	20.40	13.11	16.66	2.5	3.2
B (11)	3.25	4.93	20.62	18.26	26.20		15.88	20.22	2.5	3.2
C (13)	3.25		23.01	20.62	28.60		19.05	23.42	2.5	3.2
D (15)	3.25	4.39	24.61	23.01	31.00		23.01	26.59	2.5	3.2
E (17)	3.25	4.93	26.97	24.61	33.30		25.81	30.96	2.5	3.2
F (19)	3.25		29.36	26.97	36.50		28.98	32.94	2.5	3.2
G (21)	3.25		31.75	29.36	39.70		32.16	36.12	2.5	3.2
H (23)	3.91	6.15	34.93	31.75	42.90		34.93	39.29	2.5	3.2
J (25)	3.91		38.10	34.93	46.00		37.69	42.47	2.5	3.2

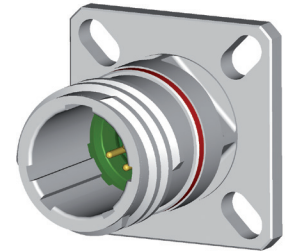

Solder mounting receptacle (type 25)

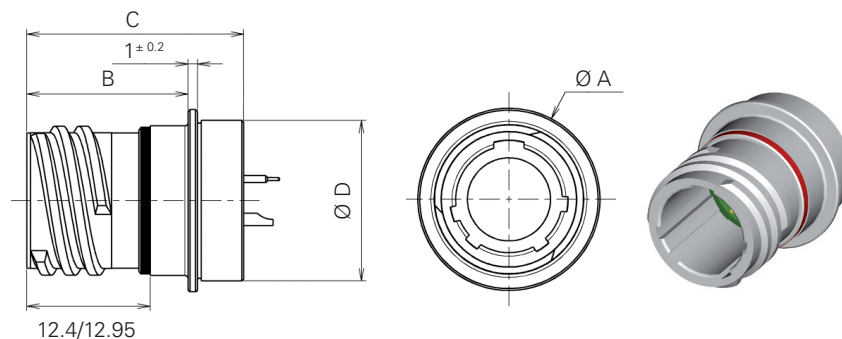

Shell size	Ø A max	B max	C max	D max
A (9)	19.40	17.20	23.80	17.10
B (11)	21.80	17.20	23.80	19.90
C (13)	24.90	17.20	23.80	23.10
D (15)	28.10	17.20	23.80	26.20
E (17)	31.30	17.20	23.80	29.40
F (19)	33.60	17.20	23.80	31.80
G (21)	36.80	17.20	23.80	35.00
H (23)	40.00	17.20	24.60	38.20
J (25)	43.20	17.20	24.60	41.30

Note: All dimensions are in millimeters (mm).

Souriau 8D series hermetic series

Dimensions

Jam nut receptacle (type 23)

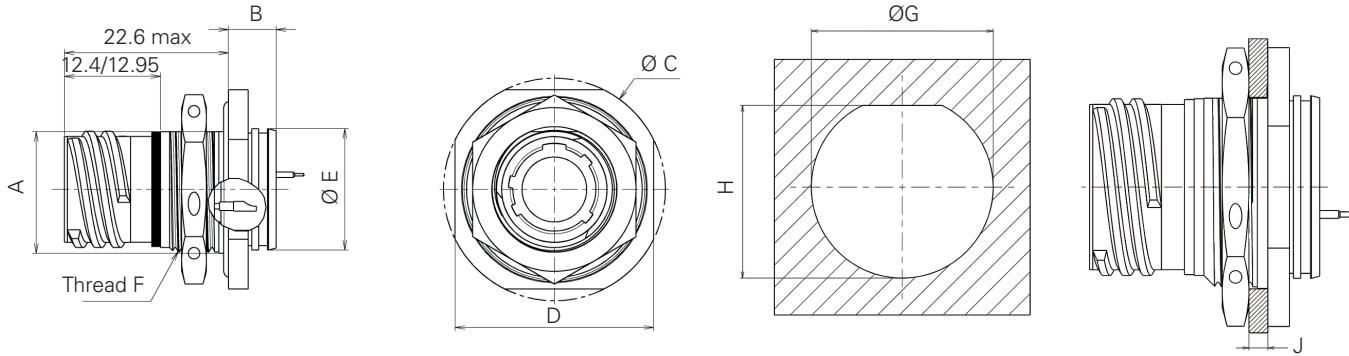

Shell size	A flat ^{+0.15} _{-0.10}	B max	ØC ^{±0.30}	D ^{±0.40}	ØE ^{±0.30/0}	F thread	ØG ^{+0.25} ₀	H	J
A (9)	16.53	9.10	30.20	27.00	16.30	M17 x 1-6g	17.60	16.70 ^{+0.10} _{-0.06}	3.2
B (11)	19.07	9.10	34.90	31.80	19.40	M20 x 1-6g	20.96	19.59 ⁰ _{-0.25}	3.2
C (13)	23.82	9.10	38.10	34.90	22.70	M25 x 1-6g	25.65	24.26 ⁰ _{-0.25}	3.2
D (15)	26.97	9.10	41.30	38.10	25.90	M28 x 1-6g	28.83	27.56 ⁰ _{-0.25}	3.2
E (17)	30.15	9.10	44.50	41.30	29.00	M32 x 1-6g	32.01	30.73 ⁰ _{-0.25}	3.2
F (19)	33.32	9.70	49.20	46.00	32.20	M35 x 1-6g	35.18	33.91 ⁰ _{-0.25}	3.2
G (21)	36.50	9.70	52.40	49.20	35.40	M38 x 1-6g	38.35	37.08 ⁰ _{-0.25}	3.2
H (23)	39.67	9.70	55.60	52.40	38.60	M41 x 1-6g	41.53	40.26 ⁰ _{-0.25}	3.2
J (25)	42.85	9.70	58.70	55.60	41.70	M44 x 1-6g	44.70	43.43 ⁰ _{-0.25}	3.2

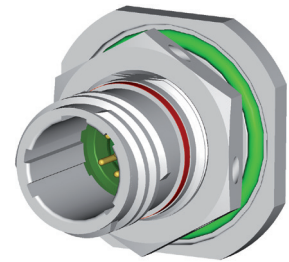

Weld mounting receptacle (type 27)

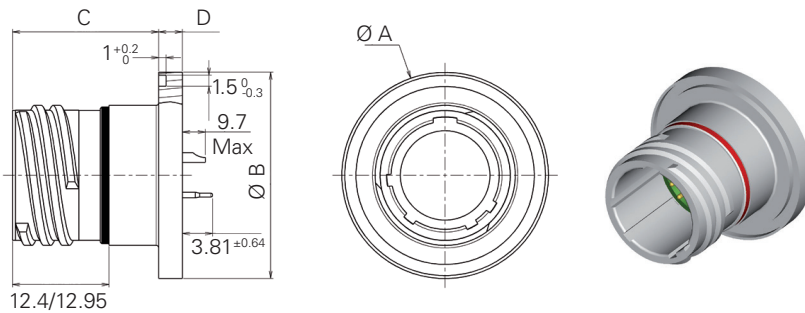

Shell size	Ø A ^{+0.3}	Ø B ^{±0.3}	C max	D ^{±0.2}
A (9)	24.70	23.90	23.20	3.20
B (11)	27.80	27.00	23.20	3.20
C (13)	31.00	30.20	23.20	3.20
D (15)	34.20	33.40	23.20	3.20
E (17)	36.40	35.60	23.20	3.20
F (19)	40.10	39.30	23.20	3.20
G (21)	43.70	42.90	23.20	3.20
H (23)	47.90	47.10	24.00	4.00
J (25)	50.10	49.30	24.00	4.00

Note: All dimensions are in millimeters (mm).

Orientations

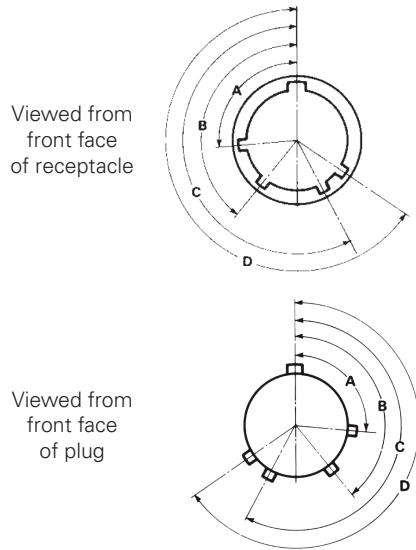

Shell size	Angles	N	A	B	C	D	E	T	V
9 (A)	A°	105	102	80	35	64	91	-	-
	B°	140	132	118	140	155	131	-	-
	C°	215	248	230	205	234	197	-	-
	D°	265	320	312	275	304	240	-	-
11 (B) 15 (D)	A°	95	113	90	53	119	51	-	-
	B°	141	156	145	156	146	141	-	-
	C°	208	182	195	220	176	184	-	-
13 (C)	D°	236	292	252	255	298	242	-	-
	A°	95	113	90	53	119	51	70	75
	B°	141	156	145	156	146	141	136	138
	C°	208	182	195	220	176	184	218	224
17 (E) 21 (G)	D°	236	292	252	255	298	242	261	268
	A°	80	135	49	66	62	79	58	85
	B°	142	170	169	140	145	153	162	150
	C°	196	200	200	200	180	197	188	191
19 (F) 23 (H) 25 (J)	D°	293	310	244	257	280	272	316	307
	A°	80	135	49	66	62	79	-	-
	B°	142	170	169	140	145	153	-	-
	C°	196	200	200	200	180	197	-	-
	D°	293	310	244	257	280	272	-	-

Gaskets and O-rings

Shell size	Gasket for receptacle Type 0 (not delivered with connector)		O-ring for receptacle Type 7 (delivered with connector)	
	Part number	Material	Part number	Material
09 (A)	85995541	Fluorosilicone	AS3582-019	Silicone
11 (B)	85995542	Fluorosilicone	AS3582-022	Silicone
13 (C)	85995543	Fluorosilicone	AS3582-024	Silicone
15 (D)	85995544	Fluorosilicone	AS3582-026	Silicone
17 (E)	85995545	Fluorosilicone	AS3582-028	Silicone
19 (F)	85995546	Fluorosilicone	AS3582-128	Silicone
21 (G)	85995547	Fluorosilicone	AS3582-130	Silicone
23 (H)	85995548	Fluorosilicone	AS3582-132	Silicone
25 (J)	85995549	Fluorosilicone	AS3582-134	Silicone

Gasket for square flange receptacle

Shell size	9	11	13	15	17	19	21	23	25
A ^{+0.2}	23.83	26.19	28.58	30.96	33.32	36.53	39.67	42.88	46.02
B ^{+0.2}	18.26	20.62	23.01	24.61	26.97	29.36	31.75	34.92	38.10
R ^{+0.4}	15.90	16.90	18.90	20.40	22.20	23.90	25.90	28.40	30.40
ØC ^{+0.2}	14.60	17.80	21.60	24.80	28.00	30.70	33.90	37.10	40.20
ØD ^{+0.4}	3.20	3.20	3.20	3.20	3.20	3.20	3.20	3.70	3.70

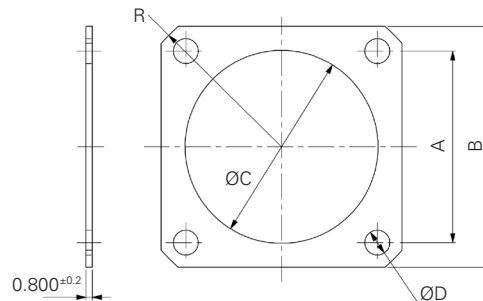

Maximum connector weight (in grams)

Shell size	09 (A)	11 (B)	13 (C)	15 (D)	17 (E)	19 (F)	21 (G)	23 (H)	25 (J)
Square flange receptacle	23	28	35	41	57	60	65	75	91
Jam nut receptacle	39	53	63	73	92	106	118	132	154
Solder mount receptacle	21	25	31	38	53	55	57	68	83

Note: All dimensions are in millimeters (mm).

Souriau 8D series hermetic series

Contact variations

Contact variations

Contact variations summary

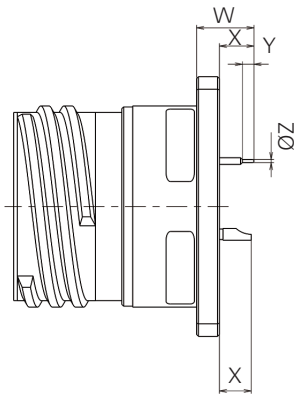

Type 21: Square flange receptacle

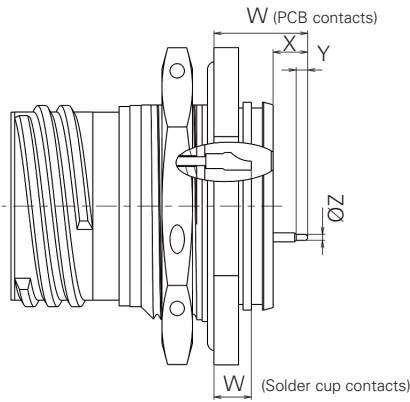

Type 23: Jam nut receptacle

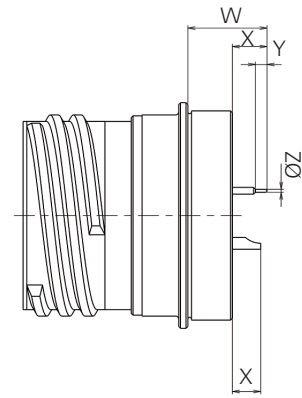

Type 25: Solder mount receptacle

Type of contact	Specification	Type of shell	Contact size	W max	X min	Y min	ØZ max
Solder cup (P)	D38999	21	20 & 22	N/A	3.45	N/A	N/A
	D38999	23	20 & 22	4.5	N/A	N/A	N/A
	D38999	25	20 & 22	N/A	2.3	N/A	N/A
PCB (C)	D38999	21	16	6.65	3.45	N/A	N/A
	D38999	21	20	6.65	3.45	0.89	0.71
	D38999	21	22	6.65	3.45	0.89	0.38
	D38999	23	16	11.5	3.3	N/A	N/A
	D38999	23	20	11.5	3.3	0.89	0.71
	D38999	23	22	11.5	3.3	0.89	0.38
	D38999	25	16	10.75	3.4	N/A	N/A
	D38999	25	20	12.15	3.4	0.89	0.71
	D38999	25	22	13.55	3.4	0.89	0.38
	840 (8D)	21	20	8.13	4.81	4.26	0.64
	840 (8D)	21	22	7.39	4.08	3.57	0.55
	840 (8D)	23	20	11.87	4.36	4.26	0.60
	840 (8D)	23	22	10.67	3.16	5.51	0.55
	840 (8D)	25	20	10.22	4.46	4.26	0.64
	840 (8D)	25	22	9.49	3.73	3.58	0.55
	840 (8D)	21	20	13.08	9.76	5.76	0.64
	840 (8D)	21	22	10.77	7.45	7.11	0.55
	840 (8D)	23	20	15.37	7.89	6.01	0.64
	840 (8D)	23	22	16.27	8.76	9.01	0.47
	840 (8D)	25	20	15.17	9.41	6.11	0.64
840 (8D)	25	22	12.86	7.10	7.11	0.55	

Note: for other contact length, please consult us.

Note: All dimensions are in millimeters (mm).



For more information, contact us:
eaton.com/interconnect-support

© 2024 Eaton
All Rights Reserved
Document No. TF700-7B
September 2024

Eaton is a registered trademark.

All other trademarks are property of
their respective owners.